

# Urban Stormwater

## Best Practice Environmental Management Guidelines

Prepared for the Stormwater Committee  
with assistance from

Environment Protection Authority,  
Melbourne Water Corporation,  
Department of Natural Resources and Environment  
and Municipal Association of Victoria

© CSIRO 1999

All rights reserved. Except under the conditions described in the *Australian Copyright Act* 1968 and subsequent amendments, no part of this publication may be reproduced, stored in a retrieval system or transmitted in any form or by any means, electronic, mechanical, photocopying, recording, duplicating or otherwise, without the prior permission of the copyright owner. Contact **CSIRO PUBLISHING** for all permission requests.

National Library of Australia Cataloguing-in-Publication entry  
Victoria. Stormwater Committee.  
Urban stormwater : best practice environmental management guidelines.  
Bibliography.

ISBN 0 643 06453 2 (paperback).  
ISBN 0 643 09350 8 (Ebook version)

1. Urban runoff – Victoria – Management.
  2. Storm sewers – Victoria.
  3. Water quality management – Victoria.
  4. Water – Pollution – Victoria.
  5. Sewage disposal – Victoria – Management.
  6. Sewage – Environmental aspects – Victoria.
- I. Title.

628.2109945

First published in 1999 by **CSIRO PUBLISHING**  
Electronic edition published in 2006 by **CSIRO PUBLISHING**

Published by:  
**CSIRO PUBLISHING**  
PO Box 1139 (150 Oxford Street)  
Collingwood VIC 3066  
Australia

Tel: (03) 9662 7666 Int: +61 3 9662 7666  
Fax: (03) 9662 7555 Int: +61 3 9662 7555  
Email: [publishing.sales@csiro.au](mailto:publishing.sales@csiro.au)  
Website: <http://www.publish.csiro.au>

## Contents

---

<b>Acknowledgements</b>	<b>vii</b>
<b>Chapter 1: Introduction</b>	<b>1</b>
1.1 What is the purpose of these Guidelines?	1
1.2 Why do we need these Guidelines?	2
1.2.1 Impacts of urbanisation	2
1.3 Who should use the Guidelines?	4
1.3.1 Local government	4
1.3.2 Development industry	6
1.3.3 State government agencies	6
1.4 How to use these Guidelines	10
<b>Chapter 2: Principles and Objectives</b>	<b>11</b>
2.1 Victorian environmental policy and stormwater management	11
2.2 Urban stormwater management principles	12
2.2.1 Preservation, source and structural control	12
2.2.2 The treatment train approach	14
2.3 Stormwater performance objectives	14
2.3.1 Determining performance objectives	14
2.3.2 Application of objectives	17
<b>Chapter 3: Stormwater Management Planning</b>	<b>19</b>
3.1 Introduction	19
3.2 The risk management approach	20
3.3 Development of a stormwater management plan	21
3.4 The process	23
3.4.1 Stage 1: Preliminary activities	23
3.4.2 Stage 2: Risk assessment	27
3.4.3 Stage 3: Development of stormwater management plan	30
<b>Chapter 4: Planning Controls</b>	<b>37</b>
4.1 Introduction	37
4.2 Land-use planning	37
4.2.1 State Planning Policy Framework	37
4.2.2 Local Planning Policy Framework	39
4.2.3 Establishing a framework for stormwater management	40
4.2.4 Implementing the vision	41
4.2.5 Permit applications	43
4.2.6 Other controls	44
4.2.7 The importance of an integrated approach	45

<b>Chapter 5: Water Sensitive Urban Design</b>	<b>47</b>
5.1 Introduction	47
5.2 Benefits of water sensitive urban design	48
5.3 Site planning	50
5.3.1 Site analysis	50
5.3.2 Land capability assessment	50
5.3.3 Land-use plans	50
5.4 Residential design tools: index	51
5.5 Commercial and industrial design tools: index	59
5.6 Site construction management practices	62
<b>Chapter 6: Source Controls</b>	<b>63</b>
6.1 Introduction	63
6.2 Municipal operations	64
6.2.1 Planning of asset construction and maintenance	64
6.2.2 Source controls for maintenance activities: index	66
6.2.3 Training and staff awareness	78
6.2.4 Council source control checklist	80
6.3 Construction activity	82
6.3.1 Site management plans	84
6.3.2 Source controls for construction activities: index	85
6.3.3 Site management plan checklist	90
6.4 Business surveys	92
6.4.1 Stormwater pollutant surveys	92
6.4.2 Stormwater quality checklists for business	93
6.5 Education programs	94
6.5.1 Developing an education program	95
6.5.2 Educational tools and techniques: index	100
6.5.3 Examples of education programs	104
6.6 Enforcement	113
6.6.1 Roles and principles of enforcement	113
6.6.2 Who should enforce?	113
6.6.3 Enforcement powers of local government	114
<b>Chapter 7: Structural Treatment Measures</b>	<b>117</b>
7.1 Introduction	117
7.2 Selecting a stormwater treatment measure	117
7.2.1 Treatment objectives	118
7.2.2 Develop treatment train	119
7.2.3 Site identification	120
7.2.4 Short-list potential treatments	122
7.2.5 Compare potential treatments	123

7.3	Primary stormwater treatment	125
7.3.1	Summary of primary treatments	127
7.4	Secondary stormwater treatment	127
7.4.1	Summary of secondary treatments	130
7.5	Tertiary treatment types	130
7.6	Flow management	132
7.7	Primary treatment: index	133
7.8	Secondary treatment: index	171
7.9	Tertiary treatment: index	193
7.9.1	Constructed wetland systems	194
7.9.2	Design of wetland systems	200
7.10	Flow management: index	217
7.10.1	Objectives and principles of flow control	218
7.10.2	Flow management techniques	218
7.10.3	Flow management design tools	220
<b>Appendices</b>		<b>229</b>
Appendix A	Example of a litter trap action plan	229
Appendix B	Sizing of sediment settling basins	235
Appendix C	Sizing of filter strips and grass swales	239
Appendix D	Design guide for infiltration trenches	241
Appendix E	Design for extended detention basins	246
Appendix F	Design guide for sand filters	249
Appendix G	Derivation of constructed wetland sizing technique	251
Appendix H	Vegetation bands for wetlands	256
Appendix I	State Planning Policy Framework	257
<b>References</b>		<b>261</b>

## Acknowledgements

---

### The Stormwater Committee

The Best Practice Environmental Management Guidelines for Urban Stormwater was commissioned and overseen by the Stormwater Committee; a partnership between Environment Protection Authority (EPA), Melbourne Water Corporation and local government aimed at improved stormwater quality. The Committee members are:

Rob Skinner (Chair)	City of Kingston
Claude Cullino	City of Monash
Tim Fisher	Australian Conservation Foundation
Helen Gibson	Department of Infrastructure
Phill Johnstone	Environment Protection Authority
Ken McNamara	City of Hobson's Bay
Bruce Mitchell	Urban Development Institute of Australia
Jane Nathan	Local Government and Planning Advisory Council
David Rae	Municipal Association of Victoria
Ian Robins	City of Wyndham
Jim Viggers	Port Phillip Catchment and Land Protection Board
Ross Young	Melbourne Water Corporation

### Project Management

---

Overall project management was carried out by

Chris Chesterfield—Melbourne Water Corporation

Technical content and text editing: Alan Alderson, Robin Allison, Chris Chesterfield, Barbara Lopreiato, Phill Johnstone

Document coordination: Robin Allison

Figures and photographs: Robin Allison and Barbara Lopreiato, Peter Drummy

### Figures and photographs

---

Many of the figures and photographs included in these Guidelines have been reproduced, with permission, from a range of sources. The authors wish to thank those publishers and authors concerned. Significant sources include: *Water Sensitive Urban Design Guidelines for the Perth Metropolitan Region* (Whelans et al., 1993) and *Stormwater Management—A Guide for Floridians* (Florida Department of Environmental Regulation, undated).

## **Contributors**

---

A number of individuals contributed to the writing of these Guidelines:

Chris Chesterfield (Melbourne Water Corporation), Tim Fletcher (Melbourne Water Corporation)

Tom McMahon, Hugh Duncan, and Lance Mudgway (Cooperative Research Centre (CRC) for Catchment Hydrology, Melbourne University)

Mike Sharpin (NSW EPA)

Andy Roy, Myf Browning, Joe Pickin and Phill Johnstone (EPA Victoria)

Tony Wong and Sara Lloyd (CRC for Catchment Hydrology, Monash University)

Peter Breen (CRC for Freshwater Ecology, Monash University)

Max Gilbert and Peter Drummy (Gilbert Consulting and CT Management)

David Rae and John Bennett (John Bennett and Associates)

Robin Allison (Woodward Clyde)

## **Stormwater Technical Working Group**

---

Many technical issues were debated and resolved by the technical working group and the authors wish to thank the members for their contributions. Members were:

Tom McMahon and Hugh Duncan (CRC for Catchment Hydrology)

Peter Breen (CRC for Freshwater Ecology)

Phil Durstan (Coomes Consulting Group)

Paul Healy (Mornington Shire Council)

Chris Chesterfield, Tim Fletcher and Scott Seymour (Melbourne Water Corporation)

Phill Johnstone (EPA)

Peter Vollebergh (Department of Natural Resources and Environment)

Robin Allison (Woodward Clyde)

Mike Sharpin (NSW EPA)

## **Education Program Case Studies**

---

Examples of education programs were gratefully provided by:

Richard Whately (Melbourne Water Corporation)

Pam Pagigotis and Donna Stoddart (City of Manningham)

Katrina Fox (Waterwatch Victoria)

Simon Fell (Melbourne Waterwatch)

Melinda Nutting (EPA)

Maree Pollard (Merri Creek Management Committee)

Ken Taylor (EPA)

Rik Brown (City of Banyule)

Bob Winters (Gould League)

Eric Bottomley and Cinnamon Evans (CERES)

# Chapter 1

## Introduction

### 1.1

#### What is the purpose of these Guidelines?

These Guidelines have been produced to assist urban catchment managers protect stormwater quality. Improved environmental performance is needed to ensure that the environmental values and beneficial uses of receiving waters are sustained or enhanced. These Guidelines assist in the development of strategies for improved environmental management of urban catchments and waterways by providing guidance in five key areas:

- **environmental performance objectives:** defining environmental performance objectives for managing urban stormwater;
- **tools review:** describing a range of tools that can reduce sources of stormwater pollution or remove pollutants from stormwater;
- **tools selection:** guiding the selection and application of these tools to suit particular situations;
- **best practices:** raising awareness of best practices for environmental management of stormwater; and
- **stormwater management plans:** providing guidance for developing stormwater management plans.

The Guidelines are designed for those people involved in the planning, design or management of urban land-uses or stormwater drainage systems that affect stormwater quality whether they be in regional urban areas or major metropolitan centres. Engineers and planners within local government along with consultants to the development industry should find these Guidelines useful. The Guidelines provide advice on the selection of components for effective environmental management of stormwater—the detailed design of these components is not covered in these Guidelines.





**Figure 1.1** Typical approach to urban drain design used in the past.

## **1.2** Why do we need these Guidelines?

---

Urban drainage systems have been developed to meet the community's need to minimise the threat of flooding. The main focus of this development has been on hydraulic capacity and transport of stormwater, rather than environmental quality.

Traditionally, little attention or resources have been allocated to considering the environmental impacts of urbanisation and providing the community with waterways that have a diverse range of uses.

Urbanisation leads to changes in both the quantity and quality of the water that is delivered to urban receiving waters. Unmanaged, these changes can result in considerable damage to the environment.

### **1.2.1** Impacts of urbanisation

---

With urbanisation, the area of impervious surfaces within a catchment increases dramatically. Densely developed inner urban areas are almost completely impervious. This high proportion of sealed area greatly reduces the amount of water infiltrating the soil and, consequently, most rainfall is converted to run-off. In addition, urban drainage systems are designed to minimise local flooding by providing smooth and direct pathways for the conveyance of run-off.

The consequences of these physical changes include:



**Figure 1.2 Many pollutants reach the stormwater system from transport and construction activities.**

- more rainfall turning into run-off;
- more frequent high flow events in creeks, rivers and receiving waters;
- reduced time lag between rainfall occurring and run-off reaching a waterway because of piping and channelising of flows; and
- reduced groundwater inflows to streams during dry weather, with a greater proportion of flows made up from human uses of water in the catchment—such as car washing, garden watering and so on.

The increased flood volumes, peak discharges and velocities in urban waterways cause a significant increase in the amounts of material (loads of pollutants) carried by the flow. Activities such as transportation and construction provide abundant sources of pollutants that are readily available for wash-off on the relatively smooth urban surfaces—Table 1.1 lists common pollutant types and their sources. Run-off carries these pollutants into waterways, and although concentrations may be diluted during a run-off event, the total loads can affect the environmental quality of downstream aquatic habitats.

These Guidelines aim to provide a range of best practices for improving the environmental performance of stormwater systems that will assist in protecting the environmental values and beneficial uses of Victoria's waterways and coastal waters.

## 1.3 Who should use the Guidelines?

There are three main groups responsible for the environmental management of urban stormwater: local government, the urban development industry, and State agencies. Through their collective and respective actions they can play an important role in maintaining and improving receiving water quality.

### 1.3.1 Local government

Local government, with its responsibility for land-use planning, land and stormwater management, has a significant ability to affect stormwater quality. Councils in the Melbourne region alone operate an estimated 25,000 kilometres of constructed drains servicing an urban area of around 150,000 hectares.

Suitable consideration of stormwater quality during the location and broad layout planning of urban areas has the potential to minimise many of the impacts of urbanisation on stormwater. Local government planners can help protect stormwater quality by ensuring the land is capable of sustaining urban development, minimising the extent of impervious surfaces and providing adequate space for stormwater detention and treatment. New drainage infrastructure should be designed to ensure the impact of urban stormwater on receiving environments is minimal.

Local government is responsible for the management of various parts of the urban environment that discharge directly into the stormwater system. These include roads, reserves, parks and car parks. Adopting a best practice environmental management approach in regard to the operation and maintenance of these resources is an essential element for improved stormwater quality.

**Local government** should use these Guidelines to:

- assess and plan operational activities which have potential to affect stormwater quality or quantity;
- develop stormwater management plans;
- plan for new development and assess development applications;
- plan and design new drainage infrastructure; and
- help identify opportunities to upgrade existing infrastructure to improve environmental performance.

<b>Pollutant</b>	<b>Urban source</b>
Sediment	Land surface erosion Pavement and vehicle wear Atmospheric deposition Spillage/illegal discharge Organic matter (e.g. leaf litter, grass) Car washing Weathering of buildings/structures
Nutrients	Organic matter Fertiliser Sewer overflows/septic tank leaks Animal/bird faeces Detergents (car washing) Atmospheric deposition Spillage/illegal discharge
Oxygen demanding substances	Organic matter decay Atmospheric deposition Sewer overflows/septic tank leaks Animal/bird faeces Spillage/illegal discharges
pH (acidity)	Atmospheric deposition Spillage/illegal discharge Organic matter decay Erosion of roofing material
Micro-organisms	Animal/bird faeces Sewer overflows/septic tank leaks Organic matter decay
Toxic organics	Pesticides Herbicides Spillage/illegal discharge Sewer overflows/septic tank leaks
Heavy metals	Atmospheric deposition Vehicle wear Sewer overflows/septic tank leaks Weathering of buildings/structures Spillage/illegal discharges
Gross pollutants (litter and debris)	Pedestrians and vehicles Waste collection systems Leaf-fall from trees Lawn clippings Spills and accidents
Oils and surfactants	Asphalt pavements Spillage/illegal discharges Leaks from vehicles Car washing Organic matter
Increased water temperature	Run-off from impervious surfaces Removal of riparian vegetation

**Table 1.1 Common pollutants and likely sources found in urban stormwater.**

### 1.3.2 Development industry

---

Urban development affects stormwater quality, both during the construction period and as a result of the increased areas of impervious surface.

Management of stormwater discharges is crucial during construction, as soil is often removed and left exposed to erosion. Massive sediment loads reaching receiving waters can be a consequence of poor site management. It is essential that construction activities are undertaken in such a way that contaminated run-off is not discharged into drains or waterways.

The level of impact on stormwater following construction depends on the site's specific land-use and layout. By minimising impervious areas and using water sensitive urban design concepts, the impact of development on stormwater quality can be minimised.

Managing urban run-off in a water sensitive manner not only helps resolve problems associated with stormwater, but can enhance the social and environmental amenity of the urban landscape. Urban developers have an important role to play in the adoption of a water sensitive approach to urban planning, design and development.

**The development industry** will use these Guidelines as a basis for the planning and design of new urban developments.

### 1.3.3 State Government Agencies

---

#### **Environment Protection Authority (EPA)**

EPA is responsible for the protection of the quality of Victoria's environment by application of the statutory powers described in the Environment Protection Act.

The role of the EPA in stormwater management includes:

- establishing environmental standards for urban waterways and bays through State environmental protection policies (SEPP);
- establishing programs for achieving environmental standards by encouraging the use of best practices; and
- facilitating the achievement of goals using regulatory and non-regulatory (e.g. best practice) means and enforcement where necessary.

**Environment Protection Authority** will use these Guidelines to provide advice on environmental management of stormwater and to assess the environmental performance of stormwater managers.

## **Melbourne Water Corporation**

As a regional drainage authority for the Melbourne metropolitan area, Melbourne Water Corporation is responsible for the management of all major drains and waterways, generally in catchments greater than 60 hectares in area. (In smaller catchments, local government generally has responsibility.) This includes around 1100 kilometres of constructed drains and 5000 kilometres of waterways.

Melbourne Water Corporation aims to provide healthy stream environments that meet the community's needs for recreation, water supply, drainage and flood protection services.

The role of the Melbourne Water Corporation in stormwater management includes:

- **strategy management:** providing overall direction and strategies for stormwater management in Melbourne;
- **drainage infrastructure standards:** setting standards for planning and design of drainage infrastructure to reduce the risks of flooding and protect receiving environments from the impacts of urban development;
- **urban area development:** working with local government and developers to plan new drainage infrastructure in developing urban areas; and
- **systems operations:** operational responsibility for waterways and the constructed drainage system.

**Melbourne Water Corporation** or its successor body will use these Guidelines as a basis for drainage infrastructure standards in all urban areas.

## **Catchment Management Authorities (CMAs)**

Catchment Management Authorities have been established in each of the nine non-metropolitan Catchment and Land Protection Regions of Victoria. These ensure the sustainable development of natural resource-based industries, the protection of land and water resources, and the conservation of natural and cultural heritage. CMAs combine the roles of the previous: Catchment and Land Protection Boards, River Management Authorities, Salinity Implementation Groups, water quality groups, and Sustainable Regional Development Committees.

CMAs provide services related to integrated waterway and flood plain management. These focus on the maintenance and improvement of river health and the minimisation of costs of flooding, while preserving the natural functions of the flood plain. These services include:

- waterway management;
- water quality management;

- management of flood plains;
- management of rural drainage including management of regional drainage schemes (where relevant);
- management of Crown frontages; and
- management of Heritage Rivers outside National Parks.

Catchment Management Authorities or their successor bodies will use these Guidelines to assist in the development and implementation of water quality and nutrient management plans.

### **Department of Natural Resources and Environment (NRE)**

NRE is responsible for the integrated management of Victoria's natural resources including their protection, conservation and environmental management. As part of this responsibility, NRE's objective is to achieve healthy rivers and catchments using a partnership approach. Consequently, NRE oversees the development and implementation of water quality and nutrient management plans and facilitates a range of water quality management initiatives.

The Department of Natural Resources and Environment will use these Guidelines to promote good environmental management of urban stormwater through its partnership approach to water quality management.

### **Other infrastructure providers**

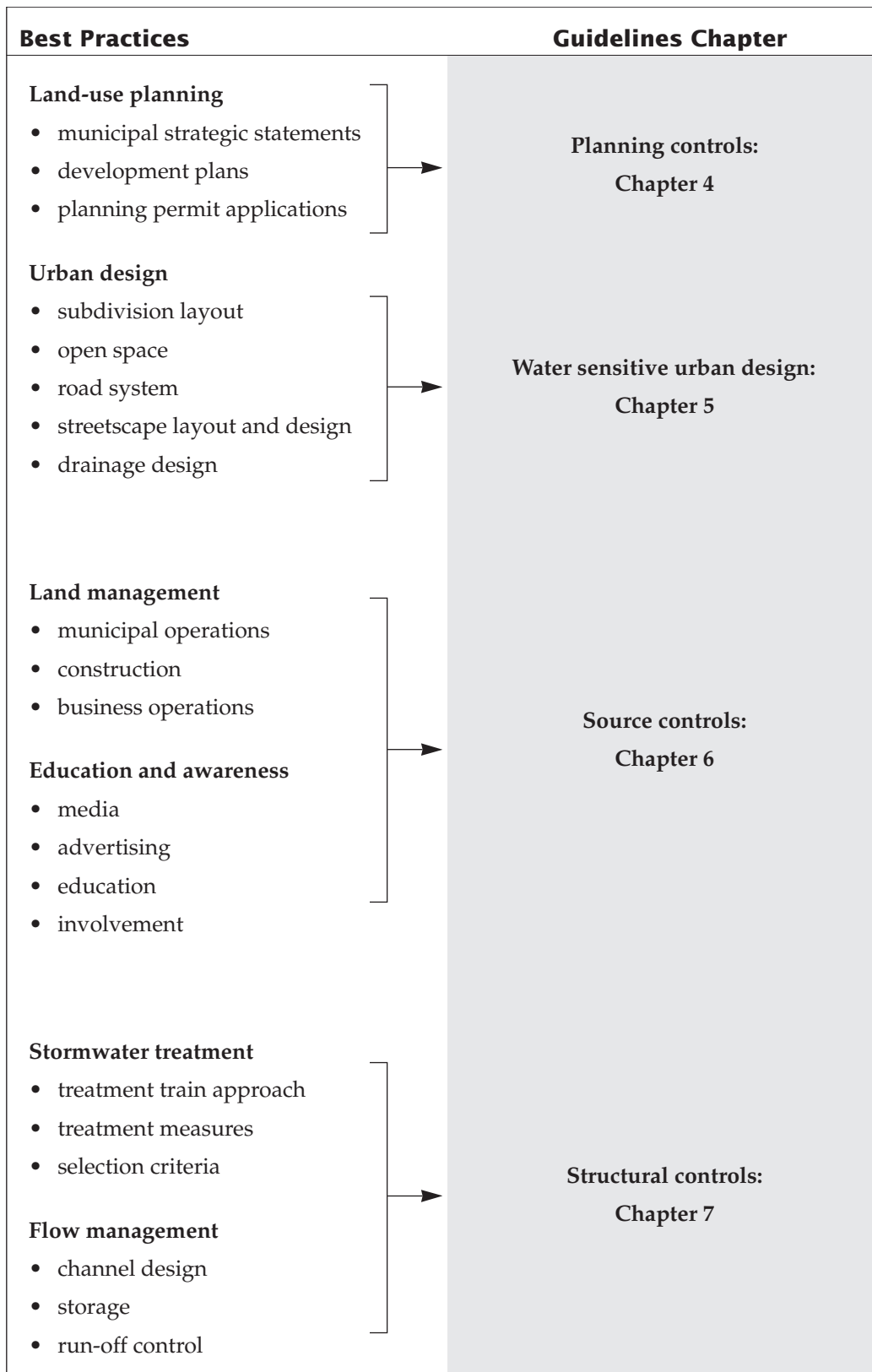
Other service providers, such as VicRoads, who play a role in stormwater management should use these guidelines as a basis for the planning and design of measures to protect the environment from the impact of run-off from any of their infrastructure.

## **1.4 How to use these Guidelines**

---

The Guidelines are intended to support the preparation of plans or strategies for the environmental management of stormwater in urban areas and the assessment of current management practices.

Chapter 2 describes principles and performance objectives for the environmental management of urban stormwater. These should provide the basis for the planning of stormwater management programs and the design of new drainage infrastructure.



**Figure 1.3 Best practices covered in the Guidelines.**



Chapter 3 presents a methodology for preparing stormwater management plans. This approach is intended principally for local government and should provide a basis for implementing best practice.

Chapters 4, 5, 6 and 7 describe a range of tools available to meet the environmental performance objectives. These include both source controls (such as education programs to reduce pollution sources) and structural controls (such as wetlands to reduce nutrient loads). Figure 1.3 illustrates where to find the tools in the Guidelines.

# Chapter 2

## Principles and Objectives

### 2.1

### Victorian environmental policy and stormwater management

State environment protection policies (SEPPs) provide a clear statutory framework of publicly agreed environmental objectives. SEPPs identify the 'beneficial uses' (indicating the environmental values) of the land, water or air environment in any particular place. They establish environmental quality objectives at levels which will ensure the protection of these uses. As legally enforceable statutory instruments, SEPPs provide the cornerstone for a wide range of environmental protection and management activities in Victoria.

There are several SEPPs that include urban waterways and other urban waters. *State Environment Protection Policy (Waters of Victoria)* is the statewide policy. This policy contains some catchment specific Schedules—for example Port Phillip Bay and Yarra River. There are also some separate SEPPs for individual catchments such as Western Port. These are progressively being reviewed and included as schedules under the *Waters of Victoria* policy.

The *State Environment Protection Policy (Waters of Victoria)* identifies a number of beneficial uses of Victoria's waterways including:

- natural aquatic ecosystems and associated wildlife;
- water-based recreation;
- agricultural water supply;
- potable water supply;
- production of molluscs for human consumption;
- commercial and recreational use of edible fish and crustacea; and
- industrial water use.

SEPP (*Waters of Victoria*) requires that run-off from urban and rural areas must not compromise the identified beneficial uses of the receiving waters. Several provisions of SEPP (*Waters of Victoria*) specifically refer to stormwater pollution and require that measures be implemented to control its environmental impact.

These Guidelines establish stormwater quality objectives to assist in determining the level of stormwater management necessary to meet the SEPP requirements.

## 2.2 Urban stormwater management principles

---

Protecting the beneficial uses of urban waterways requires an integrated approach directed at managing the volume and rate of catchment run-off, the quality of the run-off and the habitats necessary for supporting a healthy aquatic community.

Flood prevention and public safety remain as fundamental objectives of stormwater system planning and design. Stormwater quality measures should in no way compromise these objectives. In fact, many measures designed for stormwater quality control have inherent water quantity management benefits (and vice versa).

### 2.2.1 Preservation, source and structural control

---

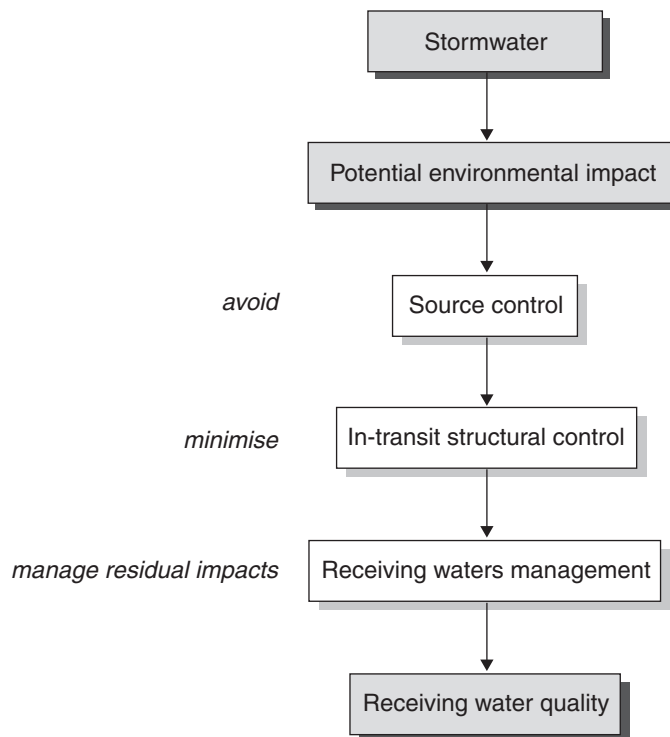
Stormwater management should be based on the following three principles:

- **preservation**: preserve existing valuable elements of the stormwater system, such as natural channels, wetlands and stream-side vegetation;
- **source control**: limit changes to the quantity and quality of stormwater at or near the source; and
- **structural control**: use structural measures, such as treatment techniques or detention basins, to improve water quality and control streamflow discharges.

These principles can be applied as part of an ordered framework to achieve environmental management objectives as described in Figure 2.1.

Source controls may be used effectively to avoid a number of stormwater impacts. These measures can include land-use planning, education, regulation and operational practices to limit changes to the quality or quantity of urban run-off before it enters the stormwater system.

Structural control, as the name implies, involves building structures to reduce or delay stormwater flow, or to intercept or remove pollutants after they have entered the stormwater system.



**Figure 2.1 Stormwater management framework.**

As a last resort, where pollutant levels or stormwater flows remain too high, it may be necessary to manage the receiving environment itself by the use of bed and bank stabilisation techniques or by installing treatment measures such as floating litter traps, by implementing a clean-up program for major pollution accumulation, or by restricting certain uses of waterways (such as recreation or water supply).



**Figure 2.2 The last resort: restricting use of receiving waters.**

## 2.2.2 The treatment train approach

Constructing a ‘treatment train’ using structural treatment measures involves the selection and sequential ordering of treatments to achieve optimal pollutant removal. Different treatments use different processes to remove pollutants, depending on the size range of the pollutant types. No one treatment can remove all stormwater pollutants. To achieve removal for a range of pollutants a number of treatments will be required and the selection and order in which they are constructed is a critical consideration.

Figure 2.3 illustrates typical pollutant types and size ranges that can be addressed with structural controls. The particle size fractions are presented and matched with the removal processes that structural treatments employ. Selection of treatment measures should be based on matching the pollutant type with the removal process.

More details on selecting treatment measures based on target pollutants are provided in Chapter 7.

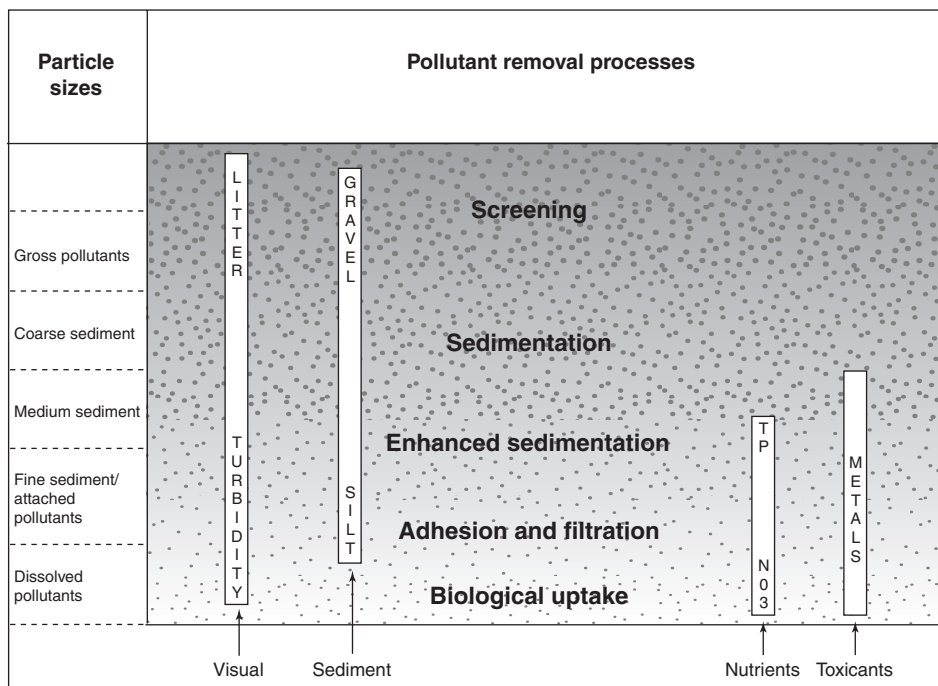


Figure 2.3 Typical pollutants and treatment processes.

## 2.3 Stormwater performance objectives

### 2.3.1 Determining performance objectives

The environmental objectives of SEPPs define the required water quality conditions of urban waterways. While the environmental objectives of SEPPs form the targets for stormwater management, there are several ways to estimate the level of stormwater

quality improvement necessary to ensure SEPP objectives can be met and the beneficial uses protected (refer Figure 2.4). These are by either:

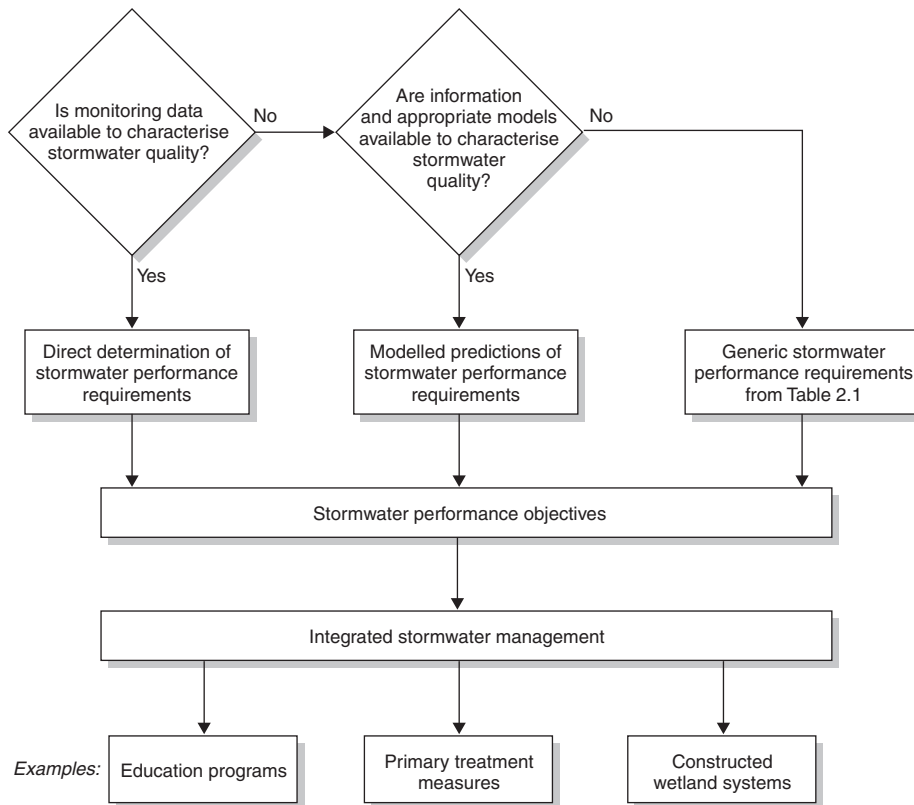
- **monitoring:** actual stormwater quality can be compared with receiving water quality to establish the level of treatment necessary to protect beneficial uses, where sufficient monitoring data are available;
- **modelling:** stormwater quality and its potential impact on receiving waters can be mathematically modelled to determine treatment requirements. Some monitoring data are usually required to validate such models; and
- **generic values:** averaged values for typical urban stormwater quality can be compared to receiving water quality and SEPP objectives to indicate the level of improvement required (refer Table 2.1).

<b>Pollutant</b>	<b>Receiving water objective:</b>	<b>Current best practice performance objective:</b>
<b>Post construction phase:</b>		
Suspended solids (SS)	comply with SEPP (e.g. not exceed the 90th percentile of 80 mg/L) (1)	80% retention of the typical urban annual load
Total phosphorus (TP)	comply with SEPP (e.g. base flow concentration not to exceed 0.08 mg/L) (2)	45% retention of the typical urban annual load
Total nitrogen (TN)	comply with SEPP (e.g. base flow concentration not to exceed 0.9 mg/L) (2)	45% retention of the typical urban annual load
Litter	comply with SEPP (e.g. No litter in waterways) (1)	70% reduction of typical urban annual load (3)
Flows	Maintain flows at pre-urbanisation levels	Maintain discharges for the 1.5 year ARI at pre-development levels
<b>Construction phase:</b>		
Suspended solids	comply with SEPP	Effective treatment of 90% of daily run-off events (e.g. <4 months ARI). Effective treatment equates to a 50thile SS concentration of 50 mg/L.
Litter	comply with SEPP (e.g. No litter in waterways) (1)	Prevent litter from entering the stormwater system.
Other pollutants	comply with SEPP	Limit the application, generation and migration of toxic substances to the maximum extent practicable
1 An example using SEPP (Waters of Victoria 1988), general surface waters segment. 2 SEPP Schedule F7—Yarra Catchment—urban waterways for the Yarra River main stream. 3 Litter is defined as anthropogenic material larger than five millimetres.		

**Table 2.1 Objectives for environmental management of stormwater.**

The preferred method for determining the required level of treatment is by use of monitoring data. However, the inherent variability in water quality experienced both in waterways and stormwater systems means that an extensive monitoring program is usually required to obtain sufficient data for such assessments.

Modelling provides an ability to predict likely changes in water quality associated with proposed urban developments. Such water quality models can be used to establish performance objectives for stormwater systems. These are limited by the availability of local



**Figure 2.4 Alternative approaches for determining stormwater performance objectives and their context in integrated stormwater management.**

water quality data and the understanding of the biological and physical processes that influence water quality and the receiving water environment. There are often significant limits on the confidence with which predictions can be made using water quality models.

The typical quality of urban stormwater and the performance capabilities of certain treatment measures have been determined from a number of studies (Mudgway et al. 1997, and Duncan 1997b).

These measures of typical urban stormwater quality can be compared to SEPP objectives to determine treatment requirements. Performance objectives for stormwater management have been derived using this approach because of the limited availability of water quality data and the limitations of modelling. Table 2.1 presents the performance objectives based on the expected improvement required to meet SEPP objectives and that can be achieved by current best practice techniques.

These performance objectives are indicative only. In many situations, where there are no extreme or unusual factors, stormwater management which achieves these objectives will generally satisfy the environmental objectives of the SEPP.

Further information on the derivation of the performance objectives in Table 2.1 can be found in: L. B. Mudgway, H. P. Duncan, T. A. McMahon and F. H. S. Chiew, 1997, *Best Practice Environmental Management Guidelines for Urban Stormwater. Background Report to*

*the Environment Protection Authority, Melbourne Water Corporation and the Department of Natural Resources and Environment, Victoria, Cooperative Research Centre for Catchment Hydrology Report 97/7, October 1997.*

Urban stormwater has a major influence on the water quality of urban waterways. Integrated stormwater management provides a means for minimising the environmental impact from urban stormwater systems. Other sources, such as sewer overflows, septic tank losses, vehicle emissions and so on, can also have significant effects on water quality. These are, however, beyond the scope of these guidelines. It must be recognised that, depending on the relative impacts of these different inputs, improvements to urban stormwater by themselves may not be sufficient to achieve SEPP requirements in some waterways.

### **2.3.2 Application of objectives**

---

The performance objectives can be achieved by employing a variety of structural and non-structural treatment measures. The stormwater performance objectives should be used to guide planning and design for the environmental management of stormwater including urban form, drainage infrastructure, maintenance and operational programs.

The tools described in Chapters 4, 5 and 6 provide stormwater quality benefits when applied in the appropriate situation or context. Therefore, all of the tools should be considered for use where practicable and in the absence of any apparent adverse impacts. The extent of water quality improvement likely to result from the use of these tools or combinations of measures can be estimated in a qualitative or semi-quantitative manner using the performance information in these guidelines. This allows some judgments to be made on the relationship between proposals and stormwater performance objectives. Consideration of all benefits, including those outside of stormwater quality, should be included in this assessment.





# Chapter 3

## Stormwater Management Planning

### 3.1 Introduction

To achieve best practice in the environmental management of stormwater, it is important that catchment management activities are guided by strategies or plans.

This section provides guidelines for the development of stormwater management plans. While it is intended mainly for application at local government levels, the process of establishing priorities and actions could also be applied to whole catchments.

Stormwater management plans (SWMPs) are a way of helping councils and other catchment managers to recognise the impacts of activities within their boundaries and to develop best practice management strategies and programs.

These guidelines are not a prescription for managing urban stormwater but describe a planning process that can be tailored to individual needs and to take account of specific social, economic and environmental factors.

Councils and other agencies have many responsibilities which are often seen as more important or of higher priority than stormwater management. Each council must make its own judgments about balancing priorities, dealing with conflicting objectives and allocating resources. SWMPs should provide a framework for making these judgments, recognising the consequences of decisions and being accountable for performance.

A **SWMP** must identify actions to improve the environmental management of urban stormwater and protect the environmental values and beneficial uses of receiving waters.

Technical knowledge is only one obstacle to improved stormwater management. More often, the main constraint is a lack of agreement that improved environmental performance is important or a lack of consensus on stormwater management priorities. A key

to achieving more effective action lies in establishing consistent priorities across agencies. The SWMP process is designed to:

- generate commitment to a best practice approach;
- identify priorities based on risk assessment;
- develop management strategies and actions; and
- establish a basis for ongoing cooperation and coordination between agencies.

Commitment is achieved mostly through involvement of a wide cross-section of council staff and key agency representatives in the planning process and through assignment of accountabilities.

Agreed priorities are identified by involving council, EPA, Melbourne Water/CMA and other key stakeholders (water authorities, for example, or VicRoads) in a systematic assessment of environmental risks associated with urban stormwater.

It is important for those with a role in improving the environmental management of stormwater to share in the process of developing the plan. This means representatives from across functional areas of council and agencies such as EPA, Melbourne Water or Catchment Management Authorities should be involved.

## **3.2** The risk management approach

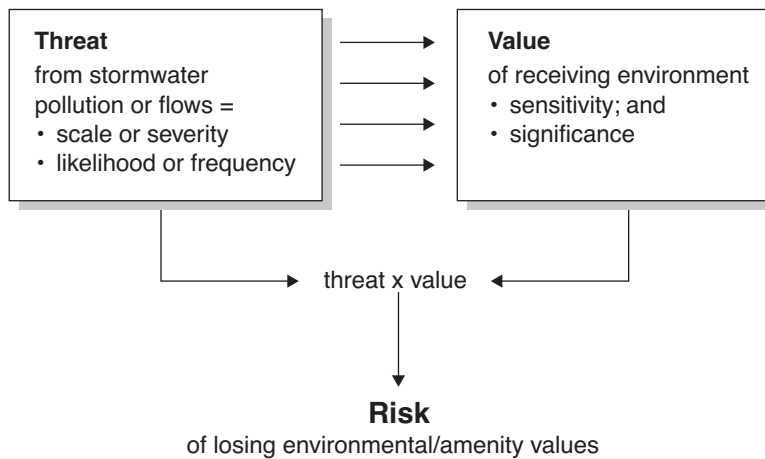
---

The risk management approach is based on assessing the risk or likelihood of losing significant values of receiving environments due to the impacts of urban stormwater.

Stormwater flows and stormwater pollution are a threat to the environmental, amenity and other values of waterways. The risk of those values being lost depends on two factors:

- the scale or severity of the stormwater threat; and
- the sensitivity of the receiving environment to that threat.

The aim of risk assessment is to identify areas where the risk of damage is greatest. As a first step we need to assign scores or rankings to the various environments or receiving waters to indicate the risk of damage due to stormwater flows or pollution. If we assign numerical values to indicate the size of the threat and the value of receiving waters, we get a measure of the risk to that environment by multiplying the two as illustrated in Figure 3.1. We then have an objective indication of risk which can be used to assign priorities.



**Figure 3.1 Risk assessment approach.**

For example, the *environmental* values of Port Phillip Bay beaches may not be particularly sensitive to litter deposited by stormwater drains. However, recreational amenity is greatly affected. Recreation values of the beaches are regarded as very significant given the level of use and are quite sensitive to litter. A pollution threat such as litter at Bay beaches is likely to rank highly in any risk assessment.

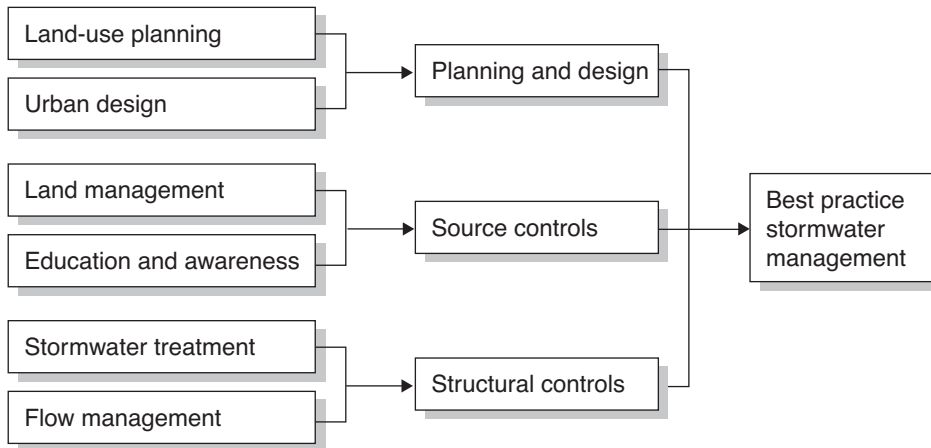
### 3.3

## Development of a stormwater management plan

The most appropriate risk management strategies for achieving improved stormwater management will depend on local circumstances. Most often, risk management will involve a combination of best practice approaches including the following:

- **planning:** planning controls should recognise the potential effects of land development and land-use on water quality;
- **operations and land management:** the way works and services such as waste collection are provided by municipalities and the private sector should be reviewed, to ensure that stormwater quality is protected;
- **education and awareness:** community and business awareness programs may be instrumental in changing attitudes and the way in which individuals treat their environment; and
- **infrastructure:** structural treatment measures such as litter traps can be used to capture and retain pollutants.

No one approach can be considered as 'best practice'. The achievement of best practice will depend on the successful integration of actions to protect stormwater quality across functional areas within council and on coordination with other agencies (Figure 3.2).



**Figure 3.2 Best practice environmental management of urban stormwater requires the integration of a range of measures within a defined program.**

When considering the application of a range of proposed approaches to the management of stormwater threats, a number of questions should be asked.

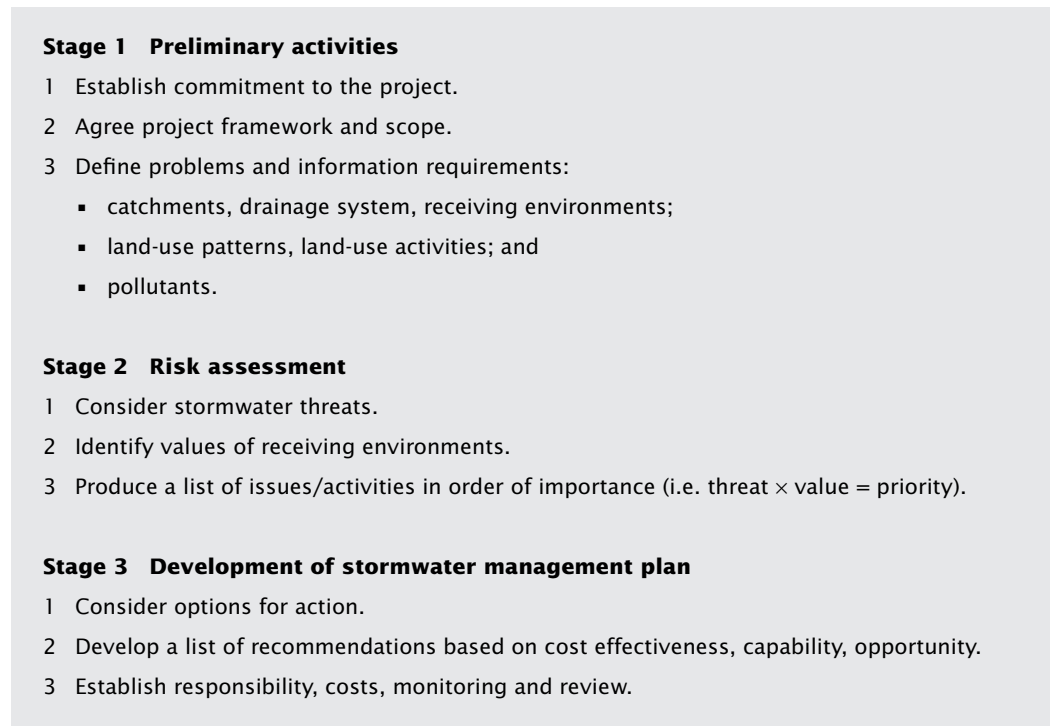
- Is the cost of measures to avoid or reduce risks high without sufficient benefit? If so, their *cost-effectiveness* is relatively low.
- Do council or others have sufficient resources, expertise or powers to implement the measure? If not, their *capability* is low.
- Is it practical to implement the measure? There may be no space for installing a structure to treat stormwater, for example. If so, the *opportunity* is lacking.

Potential management strategies should be evaluated on the basis of cost, effectiveness, capability and opportunity.

For all practical purposes, a risk free environment cannot be achieved in existing urban areas. Establishing a shared responsibility for stormwater management involving industry, community, commerce, agencies and councils will help to ensure that risks are addressed by those with the best capacity to do so.

## 3.4 The process

The process recommended for developing a SWMP is illustrated in Figure 3.3 below.



**Figure 3.3 The process for formulating a stormwater management plan.**

### 3.4.1 Stage 1: Preliminary activities

#### Part A: Framework

In this first stage, the commitment of key stakeholders is confirmed, administrative matters are agreed to and a project schedule confirmed.

<i>Purpose:</i>	To initiate and organise the planning project and obtain commitment of key stakeholders.
<i>Inputs:</i>	Context setting.
<i>Outputs:</i>	Commitment, accountability, schedule.
<i>Process:</i>	Meeting with key stakeholder representatives.

It is important to obtain the commitment of key stakeholders, especially senior council managers including the Chief Executive. The development of the plan will be led by the municipality—a senior council officer should be appointed as project manager.

### Checklist

Key stakeholders committed	<input type="checkbox"/>
Project schedule confirmed	<input type="checkbox"/>
Project manager appointed	<input type="checkbox"/>
Participants in planning process identified	<input type="checkbox"/>

## Part B: Inception

This stage involves bringing together participants in the planning process to establish the objectives of the project. It is important for participants to gain an understanding of the process, of organisational arrangements and of the need for their involvement and contribution.

<i>Purpose:</i>	To develop participants understanding, highlight key issues and identify information sources.
<i>Inputs:</i>	Context, outline of the planning process and its objectives.
<i>Outputs:</i>	Understanding, involvement, issues, information needs, timelines, map of land-uses, map of stormwater system including receiving waters.
<i>Process:</i>	Workshop, interviews, field inspections, review of documents.

This is a critical stage in the planning process involving the gathering of information to support the rest of the planning process and ensuring the active involvement of the key participants from council and other agencies.

It is recommended that representatives from council and other agencies be brought together in a workshop. This provides an opportunity to involve participants in a discussion of stormwater management issues in the municipality, including pollution and flow management threats and opportunities for improved performance. Use the workshop as a means to:

- develop understanding of the objectives of the project and the planning process;
- reinforce the role of participants in contributing to the development and implementation of the plan;
- identify key people to interview in more detail;
- identify sites for field inspections; and
- identify people to collect and provide key information required for development of the plan.

During the inception stage it is important to begin to gain an understanding of the extent to which existing and potential future activities may be a threat to receiving environments

<b>Category</b>	<b>Impacts</b>	<b>Typical sources</b>	<b>Typical components</b>
Pathogenic organisms (P)	Closure of beaches Human infection Illness and disease	Sullage, sewer overflows, animals	Faecal coliforms, bacteria, viruses
Oxygen depleting substances (D)	Low dissolved oxygen Smells, stress to aquatic life	Sullage, sewer overflows, animal waste, grass and leaf litter	Organic matter
Toxicants including metals and salts (T)	Bio-accumulation Death of aquatic life	Cars, car parks, roads, processing industries, spills, atmospheric deposition	Pesticides, herbicides, petroleum products, lead, zinc
Sediment (S), including suspended solids and turbidity	Muddy water, siltation, smothering of aquatic life	Stream erosion, construction sites, unmade roads, sand transport	Silt, sand, gravel, clays
Litter (A)	Mainly visual, interferes with aquatic life	Commercial areas, fast food outlets, plant debris	Paper, plastic, leaves, dead vegetation
Nutrients (E)	Promotes plant and algal growth, blue-green algal blooms (Eutrophication)	Sullage, sewer overflows, animals, STP discharges	Phosphorus and nitrogen
Flow	Increased volume or velocity of flows can scour or erode receiving waters. Increased freshwater volumes can affect estuarine or marine environments.	Increased stormwater runoff	Volume, frequency, velocity

Source: Pat Condina and Associates.

**Table 3.1 Stormwater threats, sources and impacts on receiving waters.**

and how well existing management processes within council and other agencies deal with stormwater issues. Examples of typical issues and their origin are given in Table 3.1.

It is important to use the inception stage to establish how a review of management processes will be undertaken. The review should cover planning, regulation, education, enforcement and operations as well as any existing structural approaches to managing stormwater impacts as outlined below. The relationship between council and other agency activities should also be examined. This information will contribute to the formulation of management strategies later in the planning process.

<i>Planning:</i>	Planning scheme, planning policies, permit conditions and the Municipal Strategic Statement (MSS).
<i>Operations:</i>	Specifications for service delivery (e.g. waste collections), asset maintenance activities, depot operation.
<i>Regulation:</i>	Integration between policy, planning controls, local laws and enforcement activities.
<i>Education:</i>	Programs aimed at those involved in activities with potential to affect the stormwater system.
<i>Infrastructure:</i>	Incorporation of structural measures into buildings, roads and drainage systems to reduce environmental impacts.



### *Document the nature of urban land-use*

It is useful at this stage to compile an overall picture of land-use activities. This is best represented by the planning scheme zones covering the area. However, local knowledge of differences between land-use types must be applied. For example, to distinguish between old and new industrial areas which may differ in the types of industries and the quality or standard of associated infrastructure. The basis of differentiation is the potential of different activities or land uses to generate pollutants.

In addition to site specific activities there are a number of transient activities, such as building construction, which must be accounted for. Other examples are building maintenance activities, home car servicing and so on. Transient activities can be significant polluters and are difficult to control.

### *Document the stormwater system*

It is also important to document the stormwater system. This is best presented as a map with physical features showing the catchments (main catchments and sub-catchments), the drainage system (main drains), and the receiving environments which might include open water ways, wetlands, lakes and coastal waters.

A context map which shows adjacent municipalities in the entire catchment is also useful.

#### **Checklist Workshop 1**

- Participants are committed
- Participants understand planning process and schedule
- Participants understand nature of stormwater impacts
- Information requirements been identified
- Responsibility for gathering information been allocated
- Key people to be interviewed have been identified
- The date of the next workshop has been agreed

#### **Checklist Stage 1 Outputs**

- A map of the stormwater system been prepared
- A map of land-use activities been prepared
- Current management processes have been reviewed and gaps identified, e.g. planning scheme, operations, local laws, integration between functional areas
- Field inspections have been undertaken
- Interviews have been undertaken

### 3.4.2 Stage 2: Risk assessment

#### Part A: Threats and values

This stage involves identifying and confirming:

- the nature and source of stormwater threats to receiving environments; and
- the values of receiving environments.

It is important to be thorough in the assessment of threats and values to avoid significant later reworking of the results.

<i>Purpose:</i>	To identify and rank the values of receiving environments and the threats posed by stormwater pollution or flows.
<i>Inputs:</i>	Reports, local knowledge, familiarisation with land-use activities and receiving environments, interviews.
<i>Outputs:</i>	Agreed ratings or rankings of stormwater threats and receiving environment values.
<i>Process:</i>	Review of existing information from stage 1, workshop to present and confirm assessments of threats and values.

#### *Threats*

A list of major site specific and transient activities with potential to damage receiving environments should be prepared which includes:

- the type of stormwater threat (see Table 3.1); and
- a significance rating of the threat.

In arriving at a significance rating, consideration should be given to the quantity of pollutant load generated and the frequency of occurrence. There will seldom be data available on the impact of these activities on receiving environments. However, an informed assessment can be based on professional judgment and experience as well as local knowledge, history of spills, complaints, age of infrastructure and so on. Discussions should take place with key people in council, EPA operations, Catchment Management Authority or Melbourne Water and others.

Table 3.2 below is an example of a listing of stormwater threats.

Activities	Location	Litter	Nutrients	Sediments	Pathogens	Toxicants	Deoxygenating materials	Flow	Significance rating
Industrial areas	Clarinda Rd/ Centre Rd								2
	Moorabbin East (Keys Rd/South Rd/Warrigal Rd)								1
	Centre Rd (Clayton)								1
	Osborne Rd (Clayton South)								1
	Westall Rd (Springvale)								1
	Heatherton Rd/Totals Rd								3
		High threat	Medium threat	Low threat					
(From City of Kingston Stormwater Management Plan, SGS 1999).									

**Table 3.2 Example of a listing of stormwater threats.**

Numerical ratings on a 1–3 or 1–5 scale are an alternative to the more qualitative ranking used in Table 3.2.

### Values

The key goal of the stormwater management plan is to protect and enhance the ‘values’ of receiving environments. These values can be categorised under a number of headings including:

- **environment:** physical and ecological attributes of waterways;
- **amenity:** recreational and landscape attributes;
- **economic:** economic benefits derived from water environments;
- **hydraulic:** contribution to protection of property and public safety from the risk of flooding; and
- **cultural:** association with known sites of cultural and heritage significance.

The values of receiving environments need to be assessed for each of these categories. This can be done qualitatively using the sort of criteria suggested in Table 3.3.

### Workshop

The results of the assessment of threats and values should be presented to stakeholders. This can involve presentation of maps, working through the ranking process used and discussion of the results. Participants should be given the opportunity to question the results and add any information that may have been missed during the assessment

Value	Category	Examples of attributes
Environment	Significance	Biodiversity, significant species (e.g. rare or threatened), treaties, protection agreements, listings, sites of significance
	Intactness or integrity	Size of intact area (e.g. continuity of habitat), remnant vegetation, level of invasion by exotic species
Amenity	Significance	Extent of open space associated with the receiving environment, extent of facilities such as trails, car parks, picnic areas, areas for canoe or boat launching, extent and continuity of public access, visual attractiveness
	Use	Visitor numbers, level of active water-based recreation or passive non-contact recreation, number of associated recreation events held at the site
Economic	Direct	Water-use, fishing or aquaculture, tourism, transport (e.g. ferry services)
	Indirect	Property values
Hydraulic		Extent to which the environment contributes to the protection of property and public safety from flooding
Cultural		Sites of cultural and heritage significance

**Table 3.3 Assessing the values of receiving environments.**

process. The aim should be to achieve consensus on the rankings of threat and value. Failure to achieve consensus at this stage may lead to arguments about priorities for action later in the planning process and require a reassessment of values and threats. It may be necessary to follow up individually with some participants to work through the detail of the assessment for particular threats or receiving environment attributes. That is, try to quickly identify what can be agreed upon at the workshop, but be prepared to spend some time on following up a few outstanding issues later.

#### **Checklist Workshop 2**

- Stormwater threats identified and presented to workshop
- Values of receiving environments identified and presented to workshop
- Good representation of stakeholders at the workshop
- Reasonable consensus achieved
- Arrangements made to follow up and resolve any significant disagreements

### **Part B: Risk assessment**

This stage involves reviewing stormwater related threats to determine the potential risks to the values of receiving environments. It should take into account:

- the transmission efficiency of drains carrying the pollution or flow threats;
- the significance of receiving water values; and
- the sensitivity of those values to the threats identified.

<i>Purpose:</i>	To assess and rank the stormwater risks to receiving environments.
<i>Inputs:</i>	Rankings or ratings of receiving water values and stormwater threats, knowledge of drainage system pathways to receiving environments.
<i>Outputs:</i>	Risk ranking of threatening activities.
<i>Process:</i>	Threat × value = risk (Figure 3.4).

A numerical rating system or a simple designation of high, medium, low as shown can be used to rank the potential risks. Figure 3.4 below is an example of a useful approach to risk ranking. The results of this ranking can be added to the significance rating column in Table 3.2.

<b>Checklist</b>	
Stormwater threats and receiving water values systematically translated into risk rankings	<input type="checkbox"/>
Rankings which seem inappropriate highlighted and explored further	<input type="checkbox"/>
Prepared to present and explain the basis of the risk rankings to stakeholder workshop	<input type="checkbox"/>

### 3.4.3 Stage 3: Development of stormwater management plan

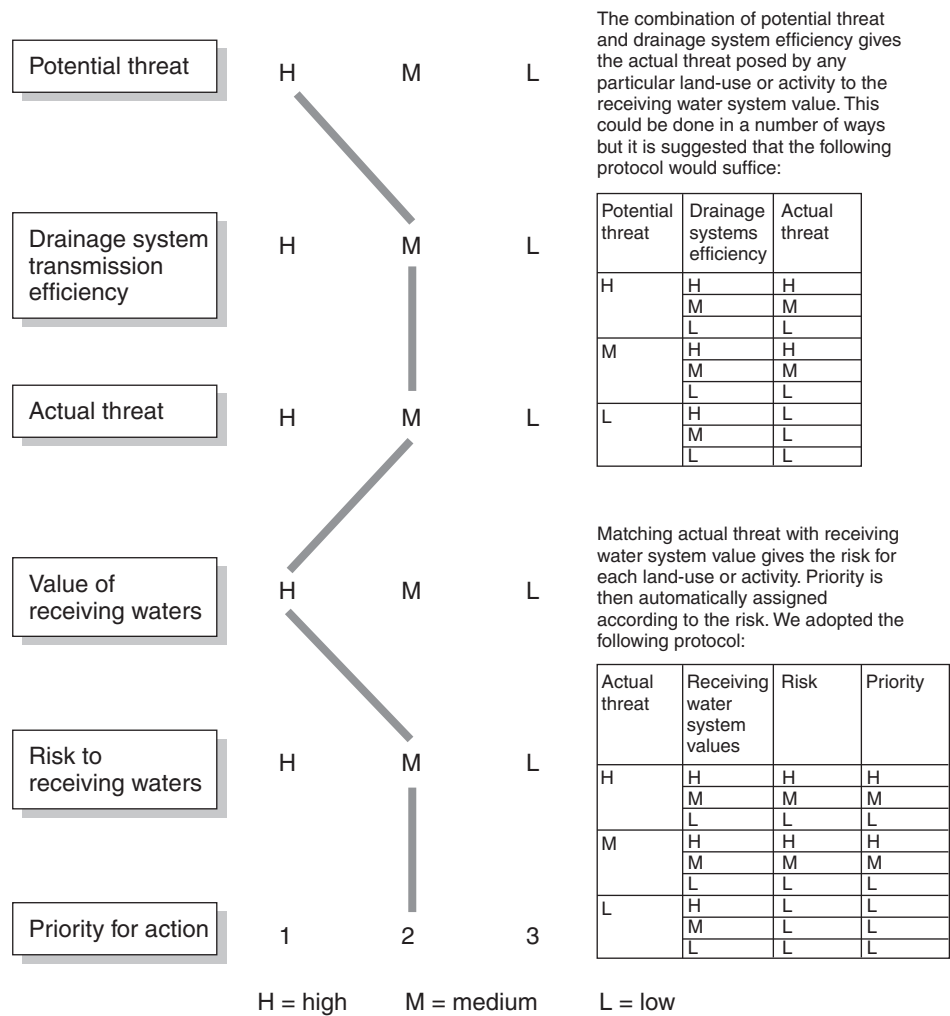
#### Part A: Management strategies

This stage involves confirming risk rankings at a workshop of stakeholders and then identifying and evaluating a range of best practice management options for managing the priority risks. These can include measures related to land-use planning, urban design, land management, operations, enforcement, education and awareness, and infrastructure (stormwater treatment).

<i>Purpose:</i>	To identify and evaluate best practice approaches to managing priority stormwater risks.
<i>Inputs:</i>	Priority risk rankings.
<i>Outputs:</i>	Priority management strategies, tasks, actions and responsibilities.
<i>Process:</i>	Workshop to present and confirm risk rankings, and to identify and evaluate management options.

Management options should be evaluated against criteria of cost, effectiveness in protecting or enhancing values (reducing risk), opportunities for implementation and capability of the municipal council or other agencies to implement. Table 3.4 provides some examples of how these criteria might be applied.

For any activity (such as land development) likely to threaten a particular receiving environment, a brief assessment of management measures related to land-use planning,



**Figure 3.4 Rating system for identifying priorities for action.**

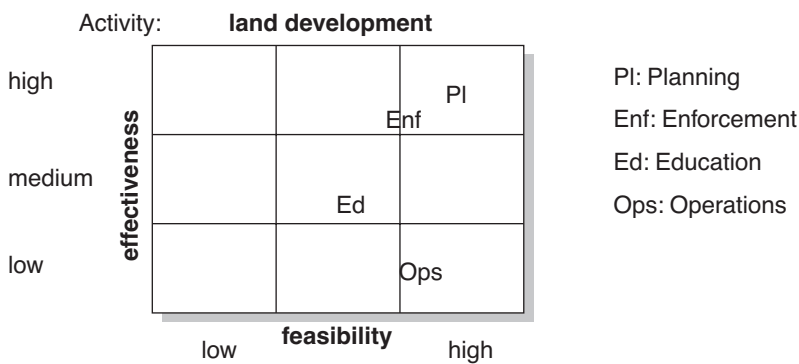
Key	
Management Approach	Symbol
Planning	Pl
Operations	Ops
Enforcement	Enf
Infrastructure	Inf
Education	Ed

urban design, land management, operations, enforcement, education and awareness and stormwater treatment and infrastructure can be undertaken quite quickly. The simple ordination shown in Figure 3.5 is a useful tool for comparing and discussing the effectiveness and feasibility of management options for each priority stormwater risk.

Be sure to take notes during the workshop to ensure you understand the reasons behind the results of the evaluation.

Category	Suggested evaluation criteria	Explanation
Effectiveness	Cost	Use approximate cost categories to compare costs. For example: major cost > \$500,000 moderate/high \$100 – \$500k moderate \$50 – \$100k low < \$50k
	Effectiveness	Assess how well the measure is likely to reduce risk.
Feasibility	Capability	Is it technically feasible to manage? Do we have enough information to be effective? Are the skills readily available? Does the technical ability or understanding exist?
	Opportunity	Are statutory powers available? What's our track record like? Do others need to be involved and will they agree to it? Is space available where structural measures are proposed? Can the measure be included as part of another project which is to be implemented e.g. drainage system upgrade.

**Table 3.4 Example of presentation of opportunities for implementation of management measures.**



**Figure 3.5 One way to present the effectiveness and feasibilities of options for comparisons.**

*Developing detailed actions*

Where particular management measures or options rate highly for feasibility and capability, detailed actions should be formulated. Where relevant these should include:

- suggested changes to planning schemes, Municipal Strategic Statement (MSS), policies and permit conditions;
- suggested changes to specifications for service delivery;
- the type, location and indicative cost of structural treatment measures;

- target groups for education programs or enforcement;
- specific locations for targeted programs (a particular industrial or commercial area or receiving environment);
- the need to further investigate the extent or nature of stormwater threats;
- the need for coordination with others;
- responsibility for leading implementation ie council department, CMA/MWC, EPA or other; and
- suggested performance measures.

### *Grouping actions into strategies*

For each category of management approach, a number of specific actions are available. See Figure 3.6 below. Priority risk activities for which a similar range of management actions are appropriate can be grouped into broad strategies. For example, an industrial and commercial areas strategy might be an appropriate way of grouping management measures to deal with a range of risk activities related to industrial and commercial land uses in the municipality. A goal or objective should be assigned to each broad strategy. For example:

Industrial and commercial areas strategy

Goal:

‘To encourage the operations of businesses in the target industrial and commercial activity areas to adopt best practice in relation to the containment of pollutants to stormwater with education as a first priority and enforcement as a last resort and at the same time to implement effective clean-up procedures and pollutant capture devices where they are necessary.’

There is also likely to be a need for a ‘Corporate Strategy’ to address the inclusion of general policies and objectives into the council corporate plan and planning scheme including the MSS. This strategy should also deal with the integration of actions across functional areas within council and with arrangements for coordination with other agencies such as EPA and MWC.

#### **Checklist**

- |   |                          |
|---|--------------------------|
| Management approaches for priority risks evaluated  | <input type="checkbox"/> |
| Detailed actions developed for priority risks where feasibility and capability are high   | <input type="checkbox"/> |
| Actions grouped into management strategies  | <input type="checkbox"/> |
| Responsibilities agreed   | <input type="checkbox"/> |
| Strategy developed for integration of actions within council and coordination with others | <input type="checkbox"/> |
| Final plan circulated for comment   | <input type="checkbox"/> |



Management options		Strategy Area						
		Sewer overflow /leaks	Industrial area	Commercial areas	Southlan	Service stations	Major roads	Building and construction
Action								
Planning	Planning permit conditions							
	Land use planning							
	Subdivisional/development planning							
	Site management plans							
Operations	Management of septic systems							
	Housekeeping and materials							
	Waste management							
	Spill prevention and clean-up							
	Contractor/contracting specifications							
	Monitoring							
	Sewer system overflow monitoring							
	Street cleaning							
	Building site debris cleaning							
	Vegetation collection/mulching services							
	Garbage collection							
	Kerbside recycling							
	Collection/disposal of domestic toxicants							
	Car park design							
	Reserve and waterway							
	Detection/audit/enforcement							
Enforcement	Planning permit/bylaw enforcement							
	Control of illegal dumping							
	Control of illegal connections							
Infrastructure	On-site sediment detention (truck washes, silt fences, etc.)							
	Soakage disposal pits							
	Alternative pavement forms							
	Grate/inlet screens/traps							
	Oil/grit separators							
	Litter basket/trap							
	Rainwater storage/reuse							
	Infiltration trenches							
	Grass swales/diversions							
	Vegetated filter/buffer strips							
	Sand filters							
	Leachate treatment/treatment							
	Sewerage system improvements							
	Trash rack							
	Floating debris traps							
	In-line litter/gross pollutant traps							
	Sediment settling basins							
	Infiltration basins							
	Constructed wetlands							
	Stabilised drainage lines							
Combined SW quantity/quality treatment basins								
Education	Community education							
	Staff/contractor education/training							
	Information dissemination							
	Industry best practice guidelines							

(Adopted from City of Kingston Stormwater Management Plan SGS 1999)

**Figure 3.6 Management option for different areas within council.**

## Part B: Implementation planning

This stage requires a meeting of senior managers from council, EPA and CMA/MWC to discuss and confirm:

- commitment to implementing strategies in the plan;
- responsibilities for actions;
- accountability for delivery;
- initial targets and reporting arrangements.

<i>Purpose:</i>	To confirm priority actions and implementation arrangements.
<i>Inputs:</i>	Priority management strategies, tasks, actions and responsibilities.
<i>Outputs:</i>	Agreement on actions to be implemented and responsibilities.
<i>Process:</i>	Meeting with senior management of council and key stakeholders.

Successful implementation of the plans will require:

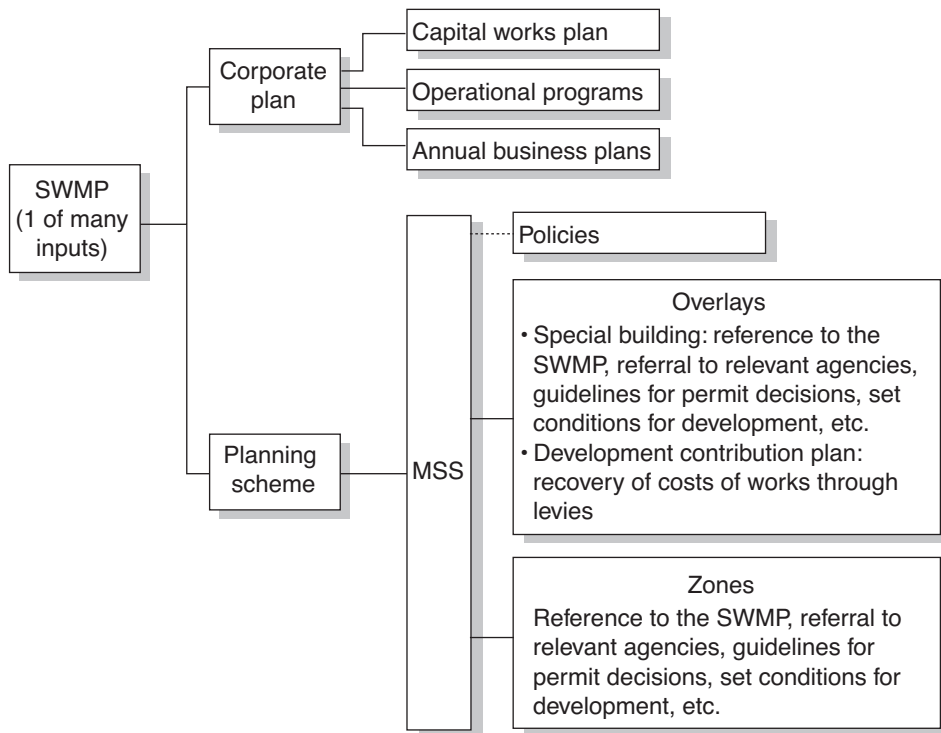
- clear expression of commitment to improved stormwater management;
- incorporation of stormwater management objectives into the statutory planning framework and other relevant plans strategies and policies;
- coordination of planning, education, operations, enforcement and infrastructure activities within council and with other agencies;
- strengthened relationship with EPA and Melbourne Water/CMA to deliver coordinated programs and ensure consistent priorities; and
- continuous improvement in operational practices particularly to ensure environmental performance objectives are written into specifications for service delivery.

The success of stormwater management plans will be evaluated by the extent to which objectives, policies and programs for the environmental management of stormwater are incorporated into:

- municipal strategic statements and planning schemes;
- operational programs;
- capital works programs;
- annual business plans; and
- developer contribution plans

of council as well as EPA, Melbourne Water and other key stakeholders. See Figure 3.7.

<b>Checklist</b>	
Senior managers in council EPA and CMA/MWC have endorsed the plan.	<input type="checkbox"/>
Responsibilities have been defined	<input type="checkbox"/>
Initial actions have been agreed for implementation	<input type="checkbox"/>
Ongoing coordination arrangements are agreed and understood and protocols are in place	<input type="checkbox"/>
Other plans, programs, policies have been modified to incorporate SWMP actions and objectives	<input type="checkbox"/>



**Figure 3.7 Relationship between SWMP and other plans, strategies and policies.**

# Chapter 4

---

## Planning Controls

### 4.1 Introduction

---

The new planning system in Victoria, based on the *Victorian Planning Provisions*, requires the development and incorporation within municipal planning schemes of a sound policy basis for subsequent detailed decision making.

The three underpinning principles for the new schemes are:

- a new format scheme is an expression of a considered vision and policies for an area and the planning requirements designed to achieve them;
- the application of requirements and controls such as zones, overlays and local provisions must have a readily discernible basis in the *Local Planning Policy Framework* (LPPF) or *State Planning Policy Framework* (SPPF); and
- the planning permit is the preferred form of development control.

Section 4.2 includes an outline of the way in which the innovative use of the new planning principles and detailed provisions can assist municipalities in the achievement of water quality objectives.

Chapter 5 provides a range of design 'tools' from which planners and designers can choose those techniques most applicable to their specific site conditions.

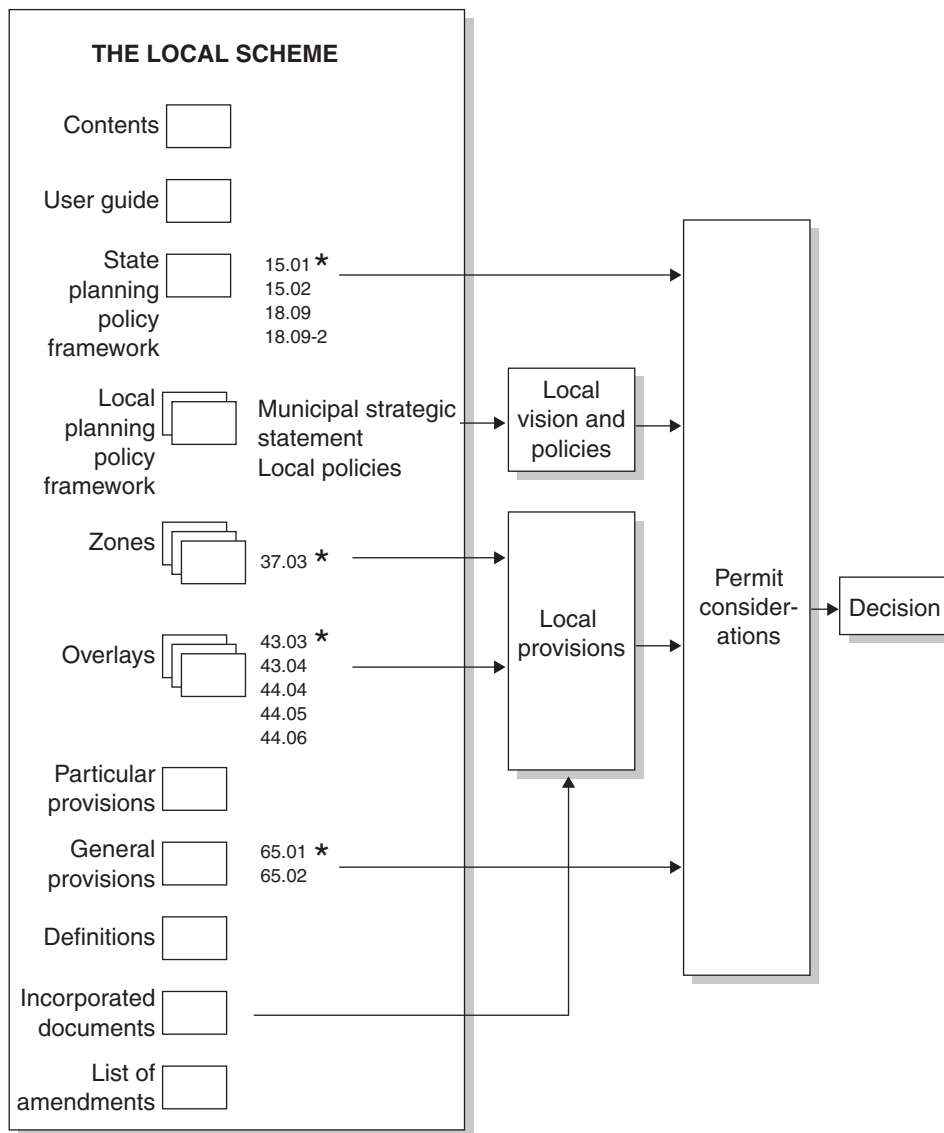
Figure 4.1 illustrates the clear linkages between the policy framework and the appropriate statutory controls.

### 4.2 Land-use planning

---

#### 4.2.1 State Planning Policy Framework

The *State Planning Policy Framework* (SPPF) sets out general principles for land use and development in Victoria, with specific policies under a series of headings. These State policies must be heeded by all planning authorities.



\* Relevant section of Victorian Planning Provisions

\* incorporates *Best Practice Guidelines*

\*\* incorporates *Stormwater Management Plan*

† clause numbers (e.g. 65.01) refer to the *Victorian Planning Provisions*

**Figure 4.1 Linking the policy framework to the permit decision.**

In relation to water quality, the SPPF emphasises the need for a cooperative approach with key stakeholders.

Integrated catchment planning for land use and resource management provides the basis for planning to protect waterways and water quality, and to minimise flood hazards, drainage infrastructure costs and downstream impacts, including on estuarine, coastal and marine environments. (SPPF, Section 13 MANAGEMENT OF RESOURCES)

This is supported by the policies contained in:

- Section 15 ENVIRONMENT and specifically
  - Section 15.01: Protection of Catchments, Waterways and Groundwater
    - Catchment Planning and Management

- Water Quality Protection
  - Section 15.02: Floodplain Management
- Section 18 INFRASTRUCTURE and specifically
  - Section 18.09: Water Supply, Sewerage and Drainage
  - Section 18.09–2: General Implementation

At present, Section 15.01–2: Water Quality Protection makes only general reference to ‘any nutrient or water quality management plan approved by government’.

It is intended that the final version of the Best Practice Environmental Management Guidelines for Urban Stormwater will be incorporated into the SPPF, thus emphasising its status.

Sections 15.01–2 and 18.09–2 of the SPPF are attached in full in Appendix I of these Guidelines.

The contributory nature of other elements is particularly highlighted in:

- Section 13: Environment
  - Management of Resources
  - Regional Cooperation
- Section 15.09–2: Conservation of Native Flora and Fauna
- Section 15.10: Open Space
- Section 18.01: Infrastructure

#### **4.2.2 Local Planning Policy Framework**

---

In the *Local Planning Policy Framework* (LPPF) the planning authority must bring together in the *Municipal Strategic Statement* (MSS) and Local Policies its overall vision for the municipality and in this particular case indicate how water quality objectives are to be achieved.

The *Municipal Strategic Statement* (MSS) should, therefore, recognise the role of infrastructure planning in achieving overall municipal goals. In the case of stormwater, that vision will recognise the wider relationship between any local drainage network and the rest of the catchment, the key features of the drainage infrastructure that are to be protected and the ways in which the drainage system can, in turn, contribute to the achievement of other municipal goals.

Fundamental requirements for the content of an MSS are set out in Section 12A of the *Planning and Environment Act*. The *Manual for the Victoria Planning Provisions* (Department

of Infrastructure 1996) clearly encourages local initiative and flair to drive the individual format of the MSS, but suggests that each MSS contain:

- a profile of key characteristics and the regional context;
- a vision statement identifying overall landuse goals for the municipality;
- clear policy links to SPPF and the corporate plan;
- strategic statements and policies about key issues;
- a future land-use framework;
- an outline of how the municipality intends to implement the MSS; and
- a program for monitoring and review.

#### **4.2.3 Establishing a framework for stormwater management**

---

As Chapter 3 indicates, the preparation of a stormwater management plan involves:

- identifying threats to receiving water environments from urban stormwater;
- identifying strategies for managing urban stormwater to protect receiving environments;
- identifying responsibilities for implementing strategies and actions to improve the environmental management of stormwater; and
- identifying opportunities to incorporate into all council management and operations activities actions and strategies to improve the environmental management of stormwater.

This is therefore the ideal process for the identification of issues and objectives for inclusion in the MSS and to develop local policies and statutory controls for the achievement of these objectives.

The MSS is intended to be a concise document and it will be necessary to focus on key challenges and strategies at that level. However, by making the municipal stormwater plan a document referred to in the MSS, the full detail would be readily available.

A possible approach is illustrated opposite.

This brief description could be accompanied by a drainage features plan to illustrate the broad geographic pattern of key drainage features. This might include:

- key drainage lines including drains, channels, waterways and floodways;
- existing wetlands and floodplains;

## City of \*\*\*\*\* Stormwater Profile

The City of \*\*\*\*\* lies at the receiving end of the major drainage system of the \*\*\*\*\* catchment in \*\*\*\*\* Melbourne. The \*\*\*\*\* Creek, \*\*\*\*\* River and the network of connecting waterways and drains accept waters from the creeks much higher in the catchment, such as the \*\*\*\*\* and \*\*\*\*\* Creeks. These all play a critical role in channelling water through the municipality to Port Phillip Bay and protecting the surrounding land from flooding.

The adjoining floodplains and wetlands running from \*\*\*\*\* in the south through the \*\*\*\*\* wetlands to \*\*\*\*\* Park provide benefits to the drainage system by allowing major opportunities for treatment of waters before they reach the Bay.

In turn this creates areas of rich habitat significance providing major contributions to the overall amenity of the area and its recreational potential.

The Port Phillip Regional Catchment Strategy indicates that many of these waterways are in poor condition and require significant improvements in stormwater planning to ensure they do not deteriorate further.

Water quality in the network must meet the requirements of the SPPF and all development must be consistent with the Municipal Stormwater Management Plan (if this has not been finalised, comply with the Best Practice Environmental Guidelines for Urban Stormwater).

- existing and potential open space or major vegetation networks which make a significant contribution to the drainage function; and
- major overland flow paths.

### 4.2.4 Implementing the vision

---

#### Use of zones, overlays and related documents

A range of tools is available through the VPPs to contribute to the achievement of water quality objectives as illustrated in Figure 4.1.

The following are examples of 'single function' techniques with a spatial base.

- *Urban Floodway Zone (VPP Clause No. 37.03)*  
Applied to land in urban areas identified as part of the active floodway.
- *Land Subject to Inundation Overlay (VPP Clause No. 44.04)*  
Applied to land in rural or urban areas subject to inundation, but not part of the primary floodway.
- *Special Building Overlay (VPP Clause No. 44.05)*  
Applied to land urban areas subject to inundation, but not part of the primary floodway.



- *Incorporated Plan Overlay (VPP Clause No. 43.03)*  
May identify specific areas where more detailed planning is necessary and include specific policy measures in a document which is incorporated in the planning scheme.
- *Development Plan Overlay (VPP Clause No. 43.04)*  
May indicate areas of land where a detailed development plan is essential before development can be approved.
- *Development Contributions Overlay (VPP Clause No. 45.06)*  
May illustrate areas where a development contributions plan is in place or proposed.

Each zone or overlay has a clearly identified range of matters for consideration in making a decision. Municipal stormwater management plans (MSWMPs) should therefore consider the opportunities available to interlink with the techniques above.

### **Local policies**

Local policies can be issue- or geography-based. The following is an example of an issue-based policy for stormwater.

#### **Stormwater drainage policy**

This policy applies to all land in the municipality.

##### **Policy basis**

State Planning Policy provides for the protection of water quality through integrated catchment planning for land-use and resource management. Nine Catchment Management Authorities and the Port Phillip Catchment and Land Protection Board have been established by the State Government to develop strategies and plans to implement integrated catchment management. Victoria is a signatory to the *National Water Quality Management Strategy* and has developed *Best Practice Environmental Guidelines for Urban Stormwater*.

##### **Objectives**

To ensure that land-use activities potentially discharging contaminated run-off or wastes to waterways are sited and managed to minimise such discharges and to protect the quality of surface water and ground water resources, rivers, streams, wetlands, estuaries and marine environments.

##### **Policy**

Policy is that:

Urban development be designed in accordance with the adopted municipal stormwater management plan or, if a plan has not been adopted, with the *Best Practice Environmental Management Guidelines for Urban Stormwater*.

Local policies can also apply to a specific area or feature and may be multi-functional in character. The following example is drawn directly from the *Manual for the Victoria Planning Provisions*.

## Skeleton Creek Environs

This policy applies to land within 100 metres of Skeleton Creek.

### Policy basis

Skeleton Creek is the second major watercourse in Wyndham, after the Werribee River. The creek is identified in the MSS as a key environmental feature in Wyndham. Urban development is encroaching upon the Skeleton Creek as part of the residential expansion. Action to manage the impact of development on the creek environs is required. The creek also provides an opportunity for a major open space link.

Reference: *Skeleton Creek Waterways and Environs Strategy*, Melbourne Water, 1996.

### Objectives

To establish Skeleton Creek as a major open space link, to safeguard water quality, to protect conservation assets and to ensure that nearby urban development is sympathetic to the creek environment.

### Policy

It is policy that:

- Natural environmental conditions be protected and enhanced, particularly in terms of weeds and soil removal.
- Landscape guidelines will be prepared for the development of Skeleton Creek.
- Development in the policy area must comply with the council's adopted Municipal Stormwater Management Plan.
- Development must comply with the *Best Practice Environmental Management Guidelines for Urban Stormwater*.

### 4.2.5 Permit applications

The State and Local Planning Policy Frameworks contain the long term direction and outcomes sought by the *Victorian Planning Provisions*. Figure 4.1 illustrates the way in which a permit decision derives its policy input from the SPPF and the LPPF and its statutory force from the relevant zone or overlay in the scheme. The SPPF lists a number of plans, strategies and guidelines which councils should give effect to under planning controls.

Councils should develop appropriate planning permit conditions as part of the development and implementation of stormwater management plans. These conditions can impose requirements related to a particular development or use of land both during construction and ongoing use of the site.

There are therefore probably two standard conditions that should appear on all permits which involve water quality considerations.

- Development in the policy area must comply with the council's adopted Municipal Stormwater Management Plan,

and/or (if a plan has not been adopted)

- Development must comply with the *Best Practice Environmental Management Guidelines for Urban Stormwater*.

and

- The owner of the land must enter into an agreement with the relevant drainage authority for the provision of drainage to the site in accordance with the authority's requirements and relevant legislation at the time. (This may form part of the general servicing condition normally placed on subdivision but should apply to development where there is no subdivision.)

Examples of other, more specific conditions are set out below.

### **Example: Planning permit conditions for stormwater protection**

- Ensure that no water containing oil, foam, grease, scum or litter shall be discharged to the stormwater drainage system from the premises.
- Ensure that all stored wastes are kept in designated areas or covered containers that prevent escape into the stormwater system.
- Ensure that measures are taken to minimise the amount of mud, dirt, sand, soil, clay or stones deposited by vehicles on the abutting roads when vehicles are leaving the premises.
- Ensure that no mud, dirt, sand, soil, clay or stones are washed into or allowed to enter the stormwater drainage system.
- Ensure that the site be developed and managed to minimise the risks of stormwater pollution through the contamination of run-off by chemicals, sediments, animal wastes or gross pollutants in accordance with currently accepted best practice.

#### **4.2.6 Other controls**

Section 12 of the *Water Act 1989* imposes a duty upon councils to include conditions if, by granting a permit, the existing drainage regime of the area may be affected. Section 12 provides that a person who has power under any Act to authorise or permit any activity, or change in the use of land, that may affect the existing drainage regime:

- (a) must make the authorisation or permission subject to conditions that, in the opinion of the person, are required to ensure the conservation of waterways, wetlands and aquifers; and
- (b) may withhold the authorisation or permission until any works are carried out or any measures are undertaken by the person, for avoiding or lessening any possible adverse effect of the granting of the authorisation or permission.

Councils may also impose conditions for stormwater quality management by entering into an agreement with a landowner (and Melbourne Water as an interested party) under Section 173 of the *Planning and Environment Act 1987*. An agreement may be required as part of the planning control process. It may provide for:

- the prohibition, restriction or regulation of the use or development of the land;
- the conditions subject to which the land may be used or developed for specified purposes; and
- any matter intended to advance the objectives of planning in Victoria.

An advantage of a Section 173 agreement is that it is registered on title and binds future purchasers of the land.

#### **4.2.7 The importance of an integrated approach**

---

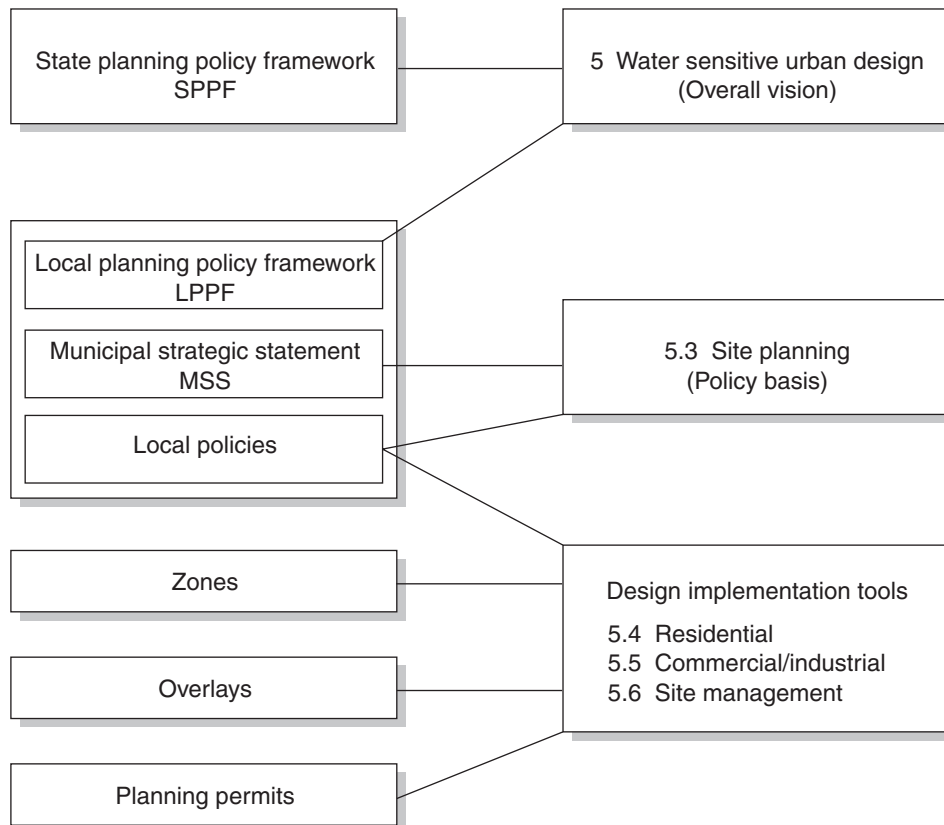
The critical linkage between land-use planning and other operational activities of council is recognised in the recent insertion of Section 12A to the *Planning and Environment Act 1987*, which requires in subsection (4):

A municipal strategic statement must be consistent with the current corporate plan prepared under Section 153A of the *Local Government Act 1989* for the municipal district.

This mandatory provision creates the opportunity for the 'municipal vision' contained in the municipal strategic statement to be realised through the complementary policies of all council departments and service providers. This is of major significance for stormwater management, where other activities such as infrastructure planning and development, parks and recreation and conservation planning can play key roles in achieving improved stormwater quality.

It is the integration of these processes that is the foundation for the new approach to planning schemes and policy implementation in Victoria.

These Guidelines support the development of an integrated approach to the environmental management of stormwater within local government. The specific area of urban development is addressed in Chapter 5. Figure 4.2 describes the link between the planning process and the urban development issues described in the balance of this chapter.



**Figure 4.2 Water sensitive design and the planning process.**

# Chapter 5

## Water Sensitive Urban Design

### Key references

Department of Planning, 1993, *Better Drainage: Guidelines for the Multiple Use of Drainage Systems*.

National Capital Planning Authority, 1993, *Designing Subdivisions to Save and Manage Water*.

Whelans, Halpern Glick Maunsell, Thompson Palmer and Institute for Science and Technology Policy, Murdoch University, 1993, *Water Sensitive Urban (Residential) Design Guidelines for the Perth Metropolitan Region: Discussion Paper*.

### 5.1 Introduction

Water sensitive urban design offers an alternative to the traditional conveyance approach to stormwater management. It seeks to minimise the extent of impervious surfaces and mitigate changes to the natural water balance, through on-site reuse of the water as well as through temporary storage.

By integrating major and minor flow paths in the landscape and adopting a range of water sensitive design techniques, the size of the structural stormwater system required can be reduced. These techniques include detention and retention basins to lower peak flows, and grassed swales and vegetation to facilitate water infiltration and pollutant filtration.

An *integrated approach* to stormwater management is the key to water sensitive urban design. This integrated approach regards stormwater as a resource rather than a burden and considers all aspects of run-off within a development, including environmental, social and cultural issues.

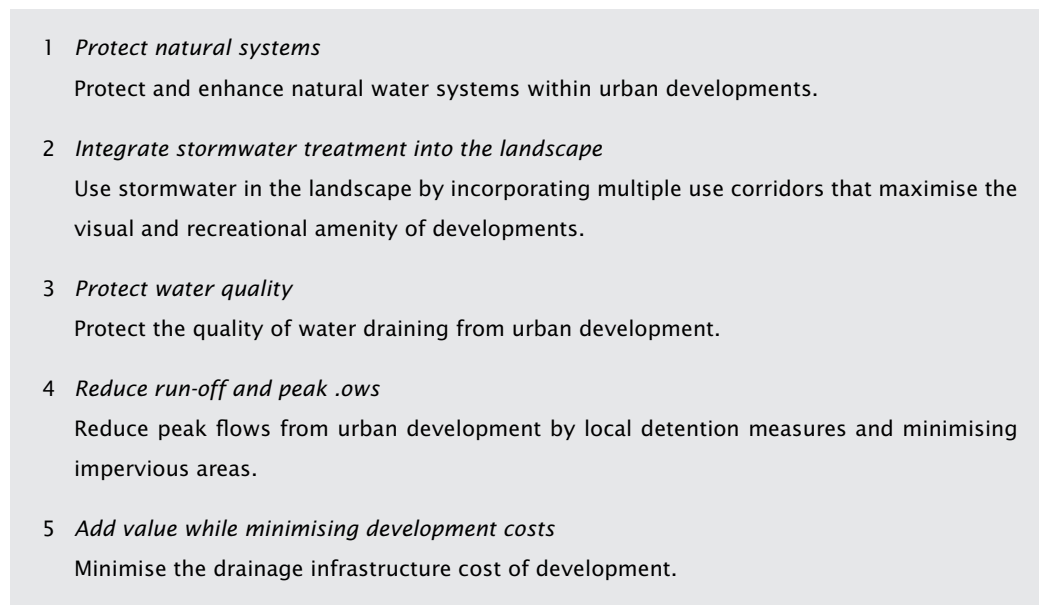
A *multi-purpose corridor* is an important design element in many integrated stormwater management systems, and it may include water features, habitat protection and recreation. These provide many benefits including:

- protection of environmental values and supporting wildlife habitats;

- filtration of stormwater (via well vegetated areas);
- recreational opportunities; and
- protection of the residential development from flooding.

Managing urban run-off in a water sensitive manner not only resolves problems associated with stormwater, but it enhances the social and environmental amenity of the urban landscape. Reducing peak flows and maintaining a more natural stormwater system can also potentially reduce capital and maintenance costs of drainage infrastructure.

The objectives of water sensitive urban design are summarised in Figure 5.1. This section presents techniques for water sensitive urban design to be incorporated into: site planning, residential design, commercial and industrial design and construction site management.



**Figure 5.1**

## **5.2** Benefits of water sensitive urban design

---

Water sensitive urban design emphasises the benefit of stormwater and waterways as a resource and an asset, rather than the conventional view of stormwater merely as a nuisance. It provides many opportunities to integrate water features in urban design and to enhance the social and environmental amenity of urban developments.

Tables 5.1 and 5.2 provide a summary of the economic, environmental and social benefits and constraints associated with water sensitive urban design.

<b>Economic opportunities</b>	<b>Economic constraints/limitations</b>
<ul style="list-style-type: none"> <li>▪ <i>Capital cost savings</i>: reduces capital costs (pipework and drains).</li> <li>▪ <i>Construction cost savings</i>: reduces construction costs (e.g. grading, tree clearing).</li> <li>▪ <i>Water quality cost savings</i>: potentially reduces the costs of water quality improvement, by retaining existing waterways.</li> <li>▪ <i>Developer cost savings</i>: reduces developer contributions for downstream drainage capacities.</li> <li>▪ <i>Improved market value</i>: incorporating water features, water frontages, networked public open space and preserving and enhancing ecological systems tends to make developments more desirable and marketable.</li> <li>▪ <i>Improved resource utilisation</i>: offers cost benefits where areas are unsuitable for residential development, but are suitable for passive recreation and contribute to required public open space allocation.</li> </ul>	<ul style="list-style-type: none"> <li>▪ <i>Market limitations</i>: the market may be sensitive to new urban forms.</li> <li>▪ <i>Maintenance/operation costs</i>: can potentially increase maintenance and operation costs.</li> <li>▪ <i>Limited developable lots</i>: potential loss of profits through the reduction in the number of developable lots. This occurs in areas that traditionally have been made available through the piping of water courses.</li> <li>▪ <i>Storm events and steep terrain</i>: there may be a possible need to supplement water sensitive treatments (such as swales) with pipes, to accommodate minor storm events and steep terrain.</li> <li>▪ <i>Land acquisition difficulties</i>: fragmented land ownership may limit the opportunity to implement water sensitive initiatives.</li> <li>▪ <i>Open space requirements</i>: the benefits may be reduced where potentially attractive residential areas must be reserved as open space.</li> </ul>

**Table 5.1 Summary of economic benefits and constraints associated with water sensitive urban design.**

<b>Environmental and social opportunities</b>	<b>Environmental and social constraints/limitations</b>
<ul style="list-style-type: none"> <li>▪ <i>Hydrological balance</i>: maintains the hydrological balance by using natural processes of storage, infiltration and evaporation.</li> <li>▪ <i>Sensitive area protection</i>: protects environmentally sensitive areas from urban development.</li> <li>▪ <i>Waterways restoration</i>: restores and enhances urban waterways.</li> <li>▪ <i>Impact reduction</i>: minimises the impact on the environment of urban development.</li> <li>▪ <i>Natural habitats enhancement</i>: can increase the diversity of natural habitats and suburban landscapes.</li> <li>▪ <i>Groundwater recharge</i>.</li> <li>▪ <i>Amenable urban and residential landscapes</i>.</li> <li>▪ <i>High visual amenity</i>.</li> <li>▪ <i>Linking</i>: opportunities to link community nodes through public open space.</li> </ul>	<ul style="list-style-type: none"> <li>▪ <i>Water table depth</i>: opportunities are limited in areas with high water tables.</li> <li>▪ <i>Topography and erosion</i>: opportunities are limited in areas of deeply dissected terrain and high slope.</li> <li>▪ <i>Ground conditions</i>: opportunities are limited in areas of poor soil (high slaking or highly dispersive) and shallow depth to bedrock.</li> <li>▪ <i>Safety perceptions</i>: perceived safety risks.</li> <li>▪ <i>Acceptance</i>: may experience some public resistance to new forms in urban landscape.</li> </ul>

**Table 5.2 Summary of environmental and social benefits and constraints associated with water sensitive urban design.**



## **5.3** Site planning

---

The process used to lay out a development is fundamental to achieving the principles of water sensitive urban design and good environmental management of stormwater. The following describes three key areas where developers can incorporate these principles at the site planning stage.

### **5.3.1 Site analysis**

---

The purpose of a site analysis is to identify and explain graphically the natural features of the area that need to be taken into consideration during planning and design. These include the area's topography, drainage patterns, soils, geology, ground cover and sensitive regions, along with significant natural attributes such as wetlands, waterways, remnant vegetation and wildlife corridors.

There should also be an assessment of the area's stormwater and drainage requirements and constraints. This should include flood control (for example the 100-year ARI flood limit), the potential maintenance of natural waterway corridors, and the provision of stormwater management structures and treatment measures.

As part of the drainage strategy required by the responsible drainage authority, developers need to demonstrate either that the proposed development will not affect the downstream systems, or that the proposed stormwater treatment measures will sufficiently mitigate potential water quality and quantity impacts.

### **5.3.2 Land capability assessment**

---

Land capability assessment analyses the physical ability of the land to sustain specific uses. It determines the scale and arrangement of development that is most consistent with water sensitive urban design principles, based on the local site features identified in the site analysis.

### **5.3.3 Land-use plans**

---

Land-use plans determine the scale and arrangement of development that is most consistent with water sensitive urban design principles for managing the drainage system.

Using the site analysis and land capability assessment, which identify and protect those areas of environmental significance, the areas of developable land can then be identified. Water sensitive land-use plans determine where development should occur within the site to produce the least impact on the ecosystem.

These plans should ensure there is adequate land area in appropriate locations designated for the purpose of stormwater management. The assessment of potential areas for

development should consider the site locations of stormwater treatment measures such as wetlands, sediment traps and infiltration/retention basins.

At this stage, it is appropriate to determine recommendations and details of cost-effectiveness for practices that:

- are most appropriate for retaining or detaining stormwater locally, given the particular conditions of soil, geology and topography involved and the anticipated land-use;
- are needed to ensure that pollution mobilisation and conveyance within and from the site are minimised; and
- increase public amenity through landscaping and the provision of wetlands and wildlife habitats where possible and appropriate.

## 5.4 Residential design tools: index

<b>Residential design tool</b>	<b>Page no.</b>
Residential design tool No. 1: Local public open space networks	51
Residential design tool No. 2: Housing layout	52
Residential design tool No. 3: Road layout	54
Residential design tool No. 4: Streetscape layout	57

### **Residential design tool No. 1: Local public open space networks**

#### *Description*

Water sensitive urban design often incorporates multi-purpose drainage corridors in residential developments. These integrate public open space with conservation corridors, stormwater management systems and recreation facilities. This has both social and economic benefits. Consequently, open space becomes more useable because of the opportunity to link and share space for multiple activities. Vegetated drainage corridors can also provide buffer strip protection for natural water features within the development.

The development of active recreation areas next to drainage facilities can introduce some elements of public safety and health risk. This requires consideration during the design phase and can often be addressed using techniques such as safety signs and barriers.

#### *Advantages*

A networked public open space system incorporating water sensitive urban design provides many opportunities including:

- integration of public open space, habitat and stormwater corridors;

- protection of natural water features with vegetated buffer strips;
- improvement of visual amenity, public access and passive recreational activities;
- incorporation of water features in public open space;
- creation of landscaped links between public and private areas;
- incorporation of pathways between community activity nodes;
- treatment of pollution and encouragement of detention and filtration of stormwater;
- possible use of stored stormwater for irrigation purposes; and
- enhanced property values.

#### *Limitations*

- networked area may be physically unsuitable for recreational activities;
- networked open space may be unevenly distributed and remote from some areas of the development; and
- development of active recreation areas next to drainage facilities needs to be carefully planned and managed.

### **Public open space: suggested measures**

- *Buffer strips*: incorporate buffer strips and grass swales that contain passive recreation elements such as walking trails along natural water features.
- *Filtration/retention basins*: integrate filtration/retention basins in public open spaces.
- *Networked public open spaces*: join public open spaces between community nodes.
- *Drainage corridors*: use drainage corridors to direct run-off to local treatment ponds.
- *Natural drainage*: maintain natural drainage lines.

Figures 5.2 and 5.3 compare the conventional design with a water sensitive design of a neighbourhood incorporating public open space.

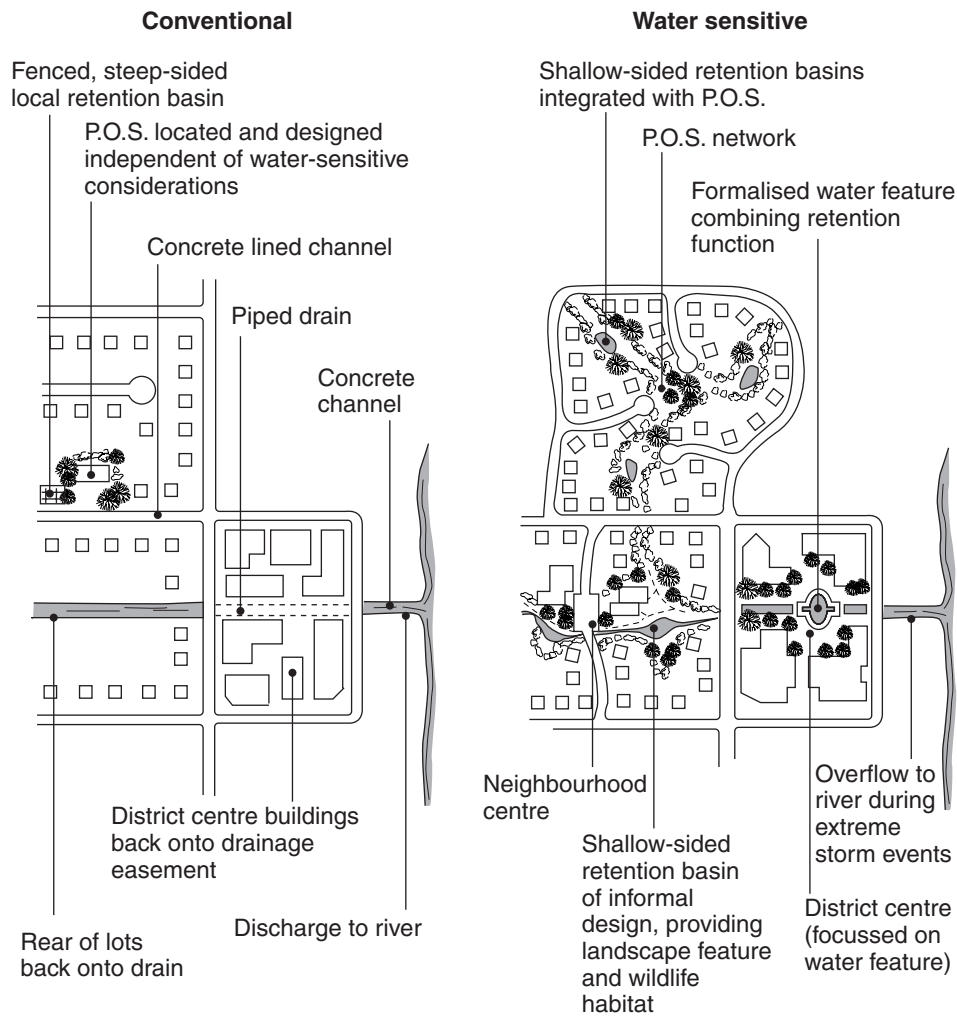
### **Residential design tool No. 2: Housing layout**

#### *Description*

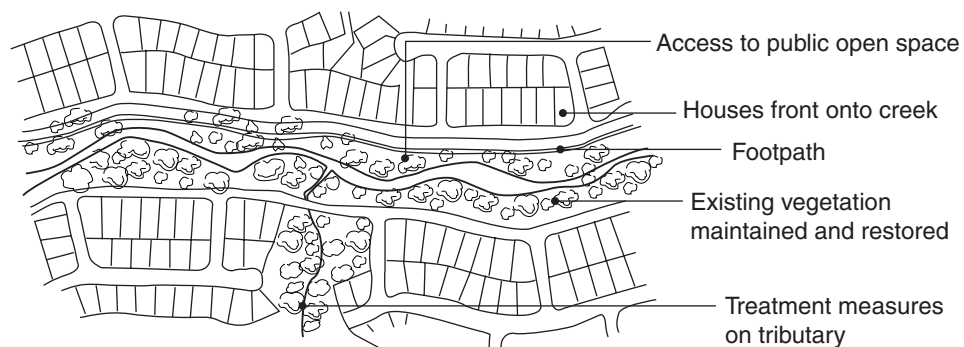
A water sensitive housing layout integrates residential blocks with the surrounding drainage function and public open space. Such housing layouts often include a more compact form of development, which reduces impervious surfaces and helps protect the water quality and health of urban waterways.

#### *Advantages*

- provides the opportunity to incorporate mixed density and use, a pedestrian focus, quality design and a distinct local identity and character;



**Figure 5.2 Networked public open space incorporated in development.**



**Figure 5.3 Integration of housing with waterway corridor.**

- reduces capital and maintenance costs per household for municipal infrastructure;
- provides a greater area of public open space within the development; and
- provides the opportunity to direct run-off from housing layouts, such as cluster developments, to water features located in public open space.

### Limitations

- compact forms of development may not be as attractive to developers and the community.

### Housing layout: suggested measures

- *Increase public open space:* encourage a reduction of private open space and an increase in public open spaces, particularly in areas adjacent to existing public open space. Introduce a flexible minimum lot size.
- *Setbacks:* setbacks from waterways should be determined according to topography, waterway flooding characteristics, vegetation and visual quality.
- *Buffer zones:* incorporate buffer zones beside creeks and retain existing remnant vegetation.
- *Orientation:* orientate residential living areas to public open space.
- *Reduced paving:* minimise the extent of paving and impervious surfaces by introducing
  - shorter residential driveways; and
  - reduced and varied building setbacks and frontages.
- *Lot geometry:* introduce a flexible lot minimum size. Where appropriate, adopt zero lot-lines,† especially for carports.
- *Housing run-off:* where possible, direct run-off from housing to a treatment point within the development site. This is best achieved within more compact developments, such as cluster developments.

† Zero lot-line: the location of a structure on a lot in such a manner that one or more sides of the structure rests directly on a lot-line.

### Residential design tool No. 3: Road layout

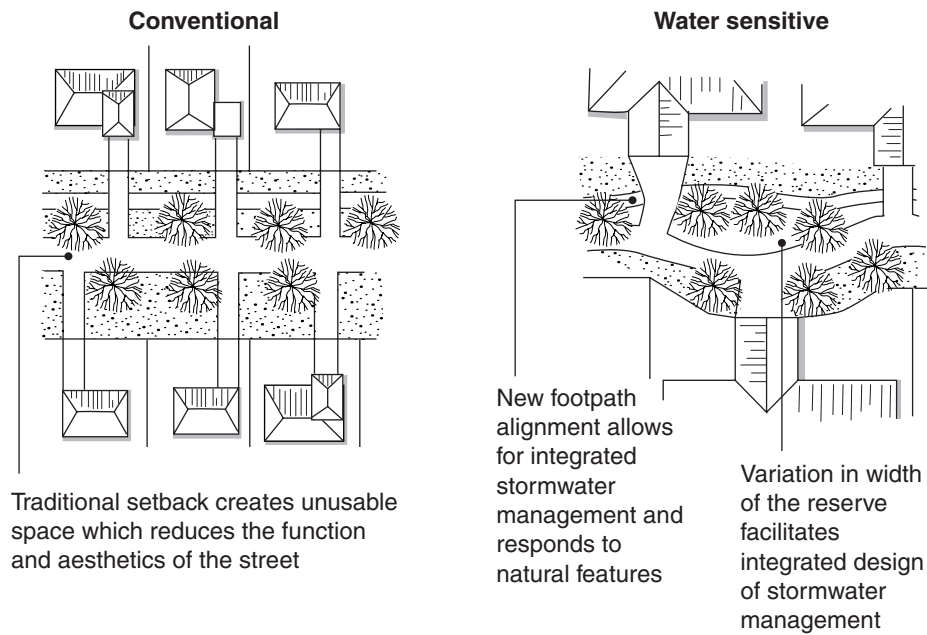
#### Description

A water sensitive road layout incorporates the natural features and topography of the site. It implements the practice of locating roads beside public open spaces wherever possible—this enhances visual and recreational amenity, temporary storage, infiltration at or close to source, and water quality. It also aims to minimise the extent of impervious road surfaces. As with all road design, road safety should not be compromised.

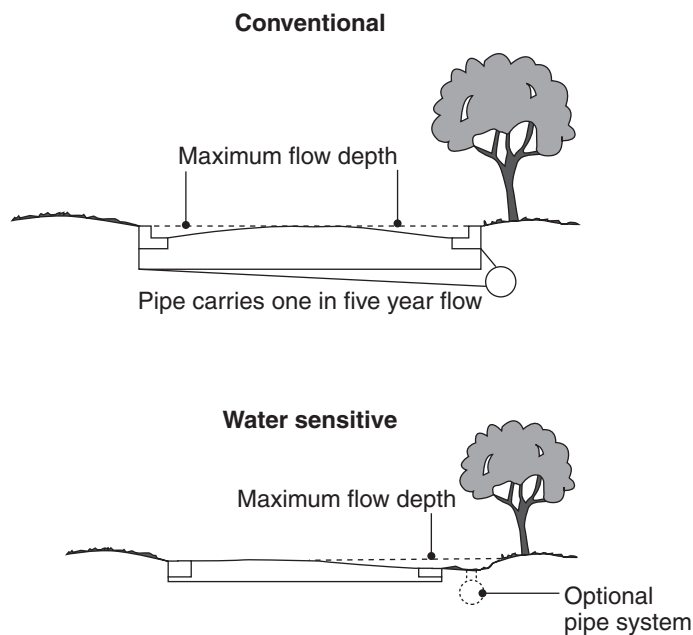
Figures 5.4, 5.5 and 5.6 illustrate the application of water sensitive design in road layout.

#### Advantages

- in new subdivisions, the road drainage system can be incorporated within the open space network or adjacent to private landscaped areas;
- reduced cost, by minimising the required capacity of the piped network; and
- offers aesthetic benefits, particularly where roads and associated open spaces are incorporated and landscaped with local spaces.



**Figure 5.4 Conventional versus water sensitive road layout.**



**Figure 5.5 Cross-section of a road.**

### Limitations

- existing road layout or irregular terrain may conflict with the drainage function;
- requires a suitable area within a roadway or nature strip to locate infiltration systems;
- infiltration may be limited by soils of low permeability and steep road gradients;
- potential conflict with standard public utility alignments;
- swales and detention in minor streets may not be readily accepted by the public; and
- incorporation of crossovers to properties may prove difficult.

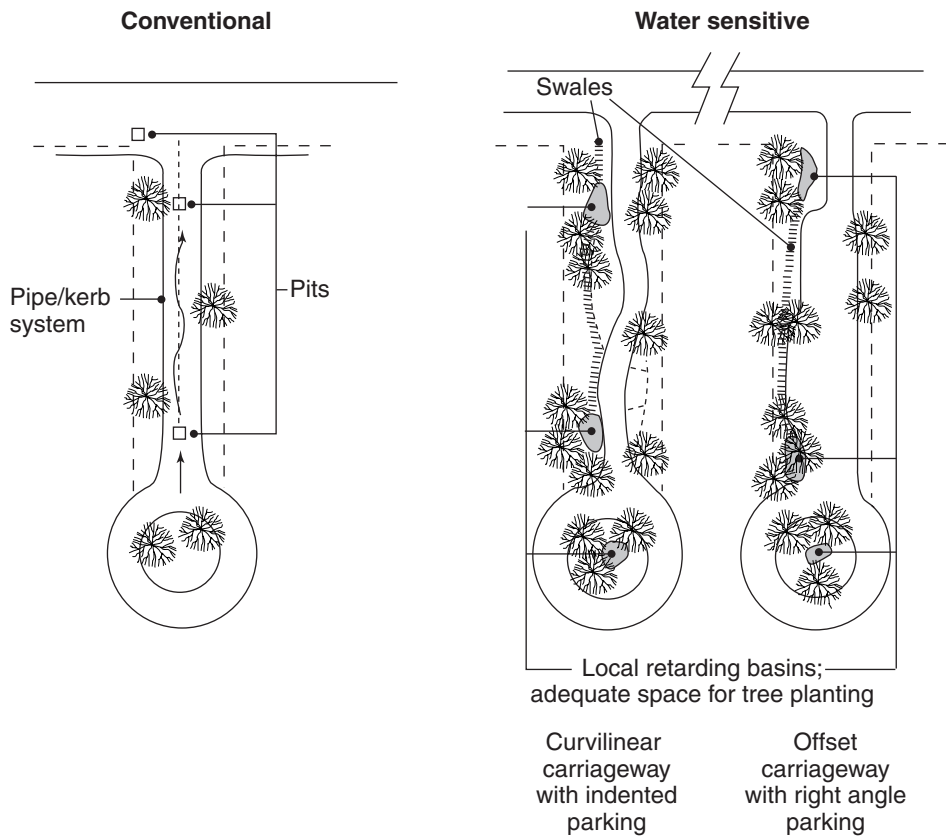


Figure 5.6 Road verge design and management.

### Road layout: suggested measures

- *Road alignment*: ensure that local collector roads run parallel to contours.
- *Access places and ways*: ensure short access places and access ways are perpendicular to the contours. Design access places and road cross falls to direct run-off to local collection/detention measures.
- *Reduce impervious surfaces*: reduce the area of impervious surfaces through
  - decreasing the length and width of low traffic local roads;
  - designing a shorter road network; and
  - using cul-de-sacs with reduced road surface areas (smaller radius, T-shaped).
- *Roadside detention*: design roadways and parking to incorporate detention basins and filtering by vegetation. Provide areas for stormwater detention and filtration along road verges where direct vehicular access is restricted or limited. Locate small detention basins, leach drains and swales in 'pockets' created by curved alignments.
- *Road location*: locate public open spaces on local collectors at the head or base of cul-de-sac to accommodate local run-off overflow (this is restricted by the gradient of the land).
- *Minor and major flows*: incorporate swales to carry minor flows along collector roads, while roads carry major storm event flows.

## Residential design tool No. 4: Streetscape layout and design

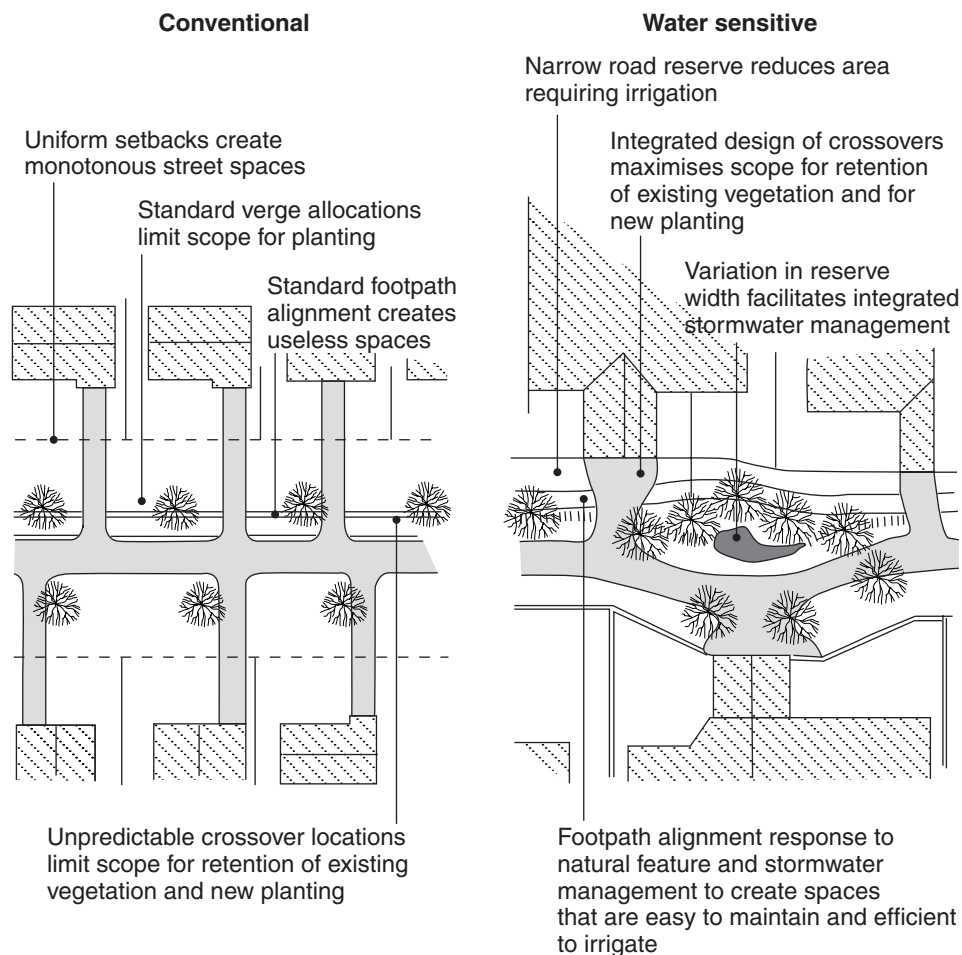
### Description

A water sensitive streetscape integrates the road layout and vehicular and pedestrian requirements with stormwater management needs. It uses design measures such as reduced frontages, zero lot-lines, local detention of stormwater in road reserves and managed landscaping.

Figures 5.7 and 5.8 illustrate the application of water sensitive design to streetscape layout and design.

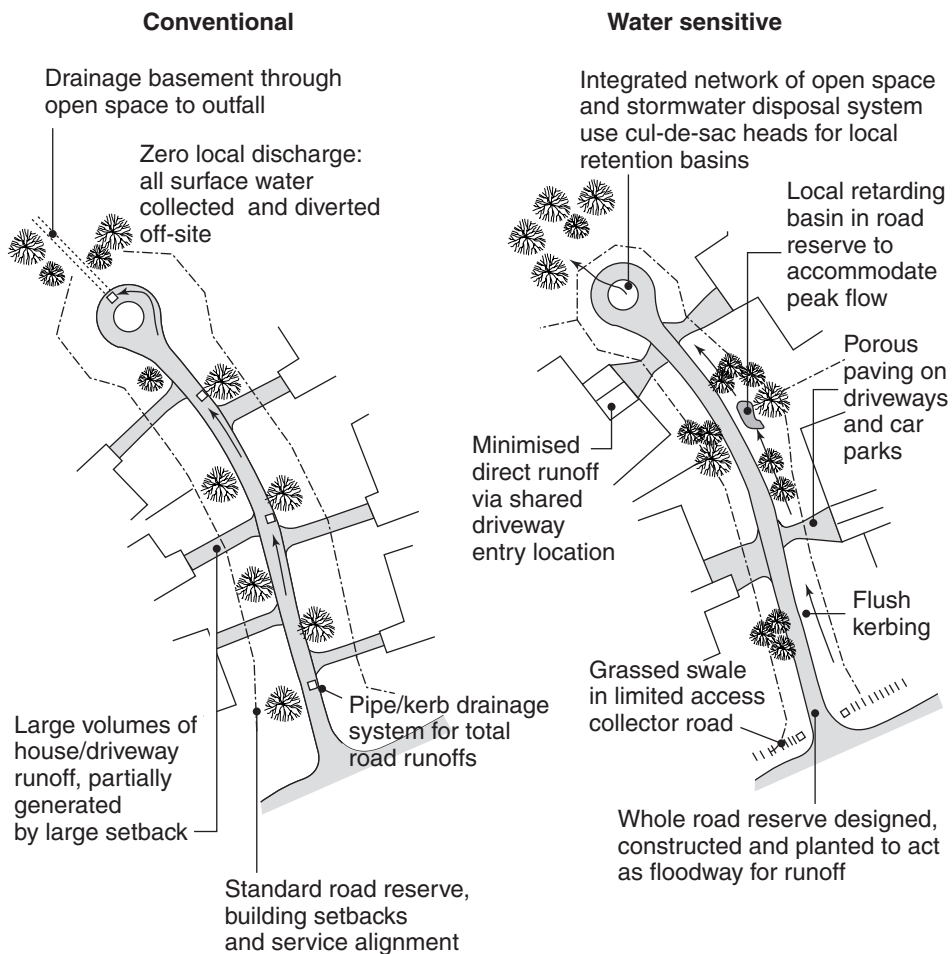
### Advantages

- incorporates water into the streetscape, using surface exposed systems in preference to underground;
- more aesthetically pleasing, with an emphasis on verge treatment by vegetation rather than road pavement;



**Figure 5.7 Building/street interface**





**Figure 5.8 Cul-de-sac streetscapes.**

- local detention or infiltration is encouraged by the use of agricultural type drains and gravel filter beds within drainage channels;
- often incorporates indigenous vegetation;
- provides enhanced public open space; and
- the variation in road reserve width enhances landscape possibilities and streetscape amenity.

#### *Limitations*

- local site conditions may limit application;
- application in established areas may be limited;
- potential conflict with standard utility alignments; and
- difficult to implement a total managed landscaping program in areas embracing a range of subdivisions or developments.

## Streetscape layout: suggested measures

- *Reduce paved areas*: reduce paved areas by
  - reducing the pavement width;
  - using smaller parking stalls;
  - incorporating footpath on one side of street only;
  - using shared driveway/entry locations.
- *Localised filtration/detention* : use localised leach drains, filtration trenches and pits to detain and filter run-off and contain peak storm events. Use cul-de-sac heads for local retention basins. Use grass swales in limited access collector roads. Incorporate site techniques such as soak wells and porous pavement.
- *Underground services*: incorporate underground power and telecommunications services to increase landscaping options.
- *Setbacks*: incorporate variable building setbacks to increase landscaping and road and drainage design options. Determine setbacks according to pavement width, servicing and landscape requirement.
- *Landscaping*: use landscaping to create interest and variety in the streetscape.
- *Crossovers*: integrate the design of crossovers with vegetation swales and local detention basins.
- *Stormwater recycling*: use stormwater to irrigate local vegetation.

## 5.5

### Commercial and industrial design tools: index

Commercial/industrial design tool	Page no.
Commercial/industrial design tool No. 1: Parking area storage	59
Commercial/industrial design tool No. 2: On-site detention for large sites	60

#### Commercial/industrial design tool No. 1: Parking area storage

##### *Description*

Parking areas can be a large generator of run-off and polluted stormwater, particularly from shopping areas. Creative design options are needed to minimise the extent of impervious surfaces of parking lots and the subsequent impacts on downstream waterways.

Gently sloping grassed areas or recessed basins can be incorporated into car parks. These may be used to pond water to allow for filtration and the deposition of sediment. This is usually accomplished by incorporating specifically designed or modified inlet structures that permit the temporary storage of stormwater. Figure 5.9 is an illustration of a landscaped car park that contains long recessed areas that store and encourage the detention and treatment of stormwater.

Car park storage is best achieved on sites that are flat to gently sloping, with suitable soils. It is essential that overflow paths for major storms are defined and that these conform with established standards. It is desirable to incorporate other stormwater treatment train processes in the design of car park storage systems.

### *Advantages*

The opportunities associated with parking lot storage include:

- integration with car park landscaping proposals and steep slope stabilisation;
- improved car park aesthetics, with an emphasis on local detention and treatment; and
- the possibility of incorporating indigenous vegetation.

### *Limitations*

- parking lot size, topography and soil conditions plus its proximity to structures and traffic routes may limit suitability;
- depth of water acceptable in detention zones may be limited; and
- requires regular maintenance as accumulated debris and sediment must be removed, along with periodic inspection of discharge control structures.

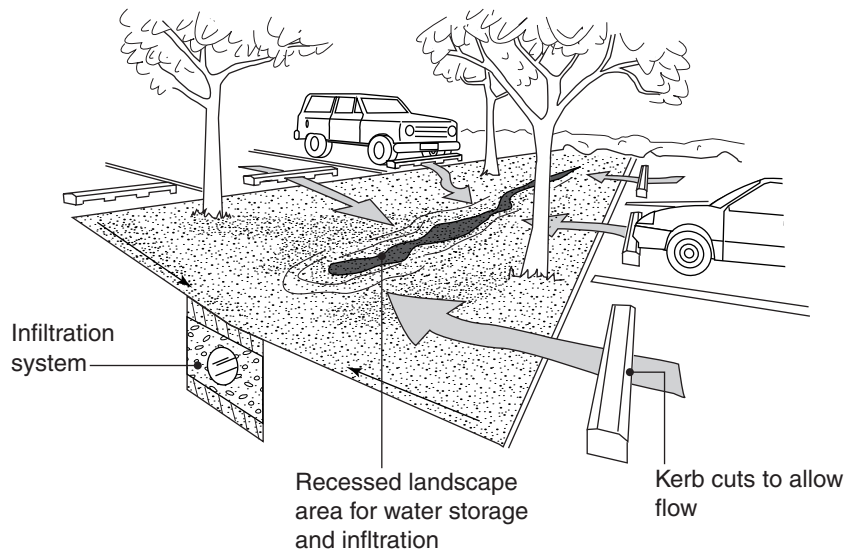
## **Parking areas: suggested measures**

- *Porous pavement*: 'overflow' of infrequently used parking areas could be constructed with porous pavement.
- *Car park storage and detention*: incorporate gently sloping grassed areas or recessed basins into car parks to encourage detention and treatment of run-off.
- *Infiltration* : use infiltration trenches where appropriate to minimise run-off from the site.
- *Retain natural drainage paths*.
- *Landscape*: incorporate vegetation to improve amenity and water use.

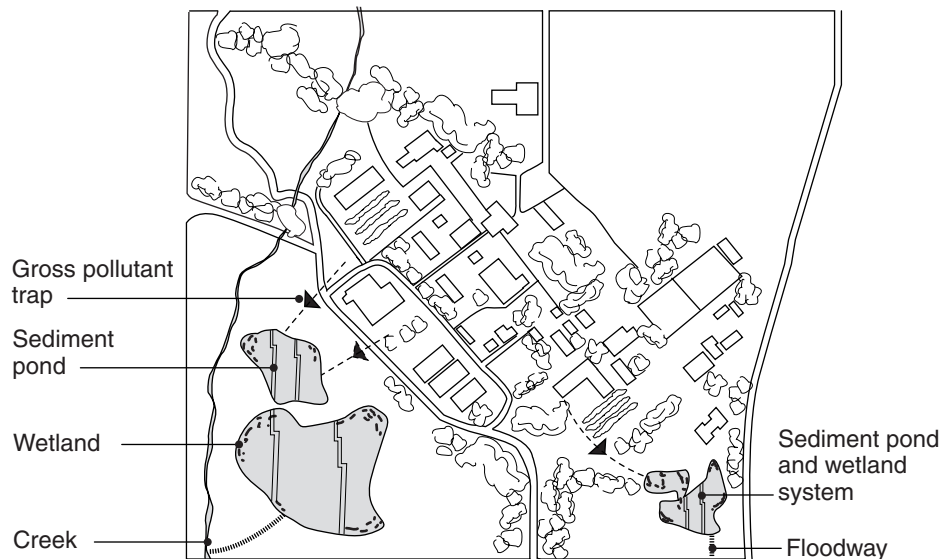
## **Commercial/industrial design tool No. 2: On-site detention for large sites**

### *Description*

Large commercial and industrial sites tend to have extensive impervious surfaces. On-site detention stores stormwater in underground tanks, driveways or landscaped depressions. If designed and used correctly, as shown in Figure 5.10, these can reduce peak discharges and reduce impacts on the downstream receiving environment.



**Figure 5.9 Gently sloping grassed area in parking area.**



**Figure 5.10 On-site detention for large sites.**

### *Advantages*

The opportunities associated with on-site detention include:

- reduced flooding risk and peak discharges downstream;
- integration with site landscaping proposals and steep site stabilisation;
- improved site aesthetics;
- the possibility of incorporating indigenous vegetation; and
- the possibility of using collected run-off for local irrigation or commercial/industrial purposes.

### *Limitations*

- site size, topography and soil conditions plus its proximity to structures and traffic may limit suitability;
- depth of water acceptable in detention zones may be limited; and
- on-site detention outlets may become blocked with debris if regular inspection and maintenance is not carried out—potentially resulting in overflow and uncontrolled discharge.

## **5.6** **Site construction management practices**

---

Eroded soils and litter are major pollutant sources during construction activity. Water sensitive urban design principles are fundamental to reducing erosion during construction.

Significant reductions in pollutants can be achieved by using a combination of improved construction practices, structural and vegetation measures and soil stabilisation techniques. An overall site management plan should be prepared, incorporating a range of control measures.

Further information on these techniques is included in Chapter 6 of these Guidelines.

# Chapter 6

## Source Controls

### Key references

NSW Department of Housing, 1998, *Managing Urban Stormwater: Soils and Construction*.

EcoRecycle Victoria, 1998, *Manufacturers Waste Reduction Manual*.

EPA, 1995, *Environmental Guidelines for Major Construction Sites*.

EPA, 1991, *Construction Techniques for Sediment Pollution Control*.

### 6.1 Introduction

Dealing with pollution at source is the most effective means of protecting stormwater quality. This chapter describes some tools available to local government and other agencies to help manage stormwater pollution resulting from municipal operations and household, business and construction activities in urban areas. These include:

- **Municipal operations:** source control measures for local government activities that may affect stormwater quality.
- **Construction activity:** developing site management plans and best practices to implement the plan.
- **Business surveys:** performing surveys to determine the nature and extent of business activities likely to cause stormwater pollution.
- **Education programs:** ways to prepare and deliver education programs to reduce stormwater pollution from household and business activities.
- **Enforcement:** measures that can be taken to complement education and other management programs.

Elements of source control dealing with managing the quantity of run-off from urban areas are covered in sections describing Water Sensitive Urban Design (Chapter 5) and Flow Management (Section 7.10).

The pollution generating activities of business and industry are not addressed in any detail by these Guidelines. Major waste management activities of industry are dealt with by EPA through licensing and waste management agreements. However, there are many waste generating activities not part of major industrial processes that are not subject directly to EPA licensing or regulation and which have significant potential to pollute stormwater.

Responsibility for dealing with these pollution generating activities rests with managers of the business enterprise. Education backed up by enforcement is the best means of ensuring business managers are aware of their potential to pollute stormwater and have knowledge of the measures available to minimise pollution risks. The business survey section provides a method for self-assessment or independent appraisal of business activities and their pollution potential, to enable better targeting of education and enforcement programs.

## **6.2** **Municipal operations**

---

Through its operations in areas such as street cleaning, waste collection and road maintenance, local government directly influences the quality of stormwater within a catchment. By applying stormwater best practices in its operational activities, local government can significantly improve the quality of urban stormwater run-off.

There are three main areas of local government activity that can affect stormwater quality. These are:

- planning of asset construction and maintenance;
- maintenance operations; and
- staff training to improve practices.

To help ensure project managers, council staff and contractors consider all aspects of water quality in their activities, a simple checklist is provided in Section 6.2.4.

### **6.2.1 Planning of asset construction and maintenance**

---

Stormwater quality is an essential consideration during the planning of asset construction and maintenance activities. An analysis of each activity's potential to pollute should be undertaken and improved methods designed into the activity to minimise pollutant generation. A number of best practice methods are described in Sections 6.2.2 and 6.3.2 for maintenance and construction activities.

### **Construction activity planning**

The construction of buildings, roads, drains and open spaces all have the potential to produce pollutants that may enter the stormwater system.

Eroded soils with associated adsorbed pollutants and litter are major pollutant sources during construction activity. Significant reductions in these pollutants can be achieved by using a combination of improved construction practices, structural and vegetation measures and soil stabilisation techniques. A site management plan should be prepared, incorporating a range of control measures that are complimentary to the construction plans.

Fundamental to reducing erosion is restricting activity in areas prone to erosion to minimise disturbance and exposure of the soil. Careful planning and siting of works will reduce the opportunity for erosion to occur.

Much municipal construction and maintenance work is performed by contractors. When developing an asset construction and maintenance specification or brief, the specification should contain a clause that stipulates the need for consideration of stormwater quality. For example:

#### **Example clause**

The impact of XXX Road must take into consideration the issue of stormwater quality and include an erosion and sediment control plan with appropriate treatments and operational features to minimise stormwater pollution in accordance with the 'Best Practice Environmental Management Guidelines for Urban Stormwater' (Stormwater Committee 1999).

For the majority of construction activity council should ensure that works are planned to minimise erosion and sediment generation. For major construction activity a site management plan should be required.

To help council staff assess any construction activity for its pollutant potential and evaluate a site management plan, a checklist is presented in Section 6.3.3.

### **Maintenance activity planning**

Sensible planning of operational procedures for each maintenance activity is the key to minimising their impact on stormwater. Inspections to identify those activities that are significant sources of pollution are an essential component of this planning process.

Information from inspections can be used to change operational activities to improve stormwater quality. Ongoing monitoring of these activities is required to ensure stormwater pollution is minimised.



Monitoring may be carried out through inspections, reviewing the number and type of complaints, and through contract reporting mechanisms. As in all survey schemes, good record keeping is vital.

## 6.2.2 Source controls for maintenance activities: index

---

There are a number of simple and practical changes to maintenance activities that local government can implement at minimal cost and achieve significant improvement in the quality of stormwater run-off.

In performing maintenance activities, the goal is to prevent waste material entering the stormwater drainage system. The following sections describe procedural guidelines for a range of typical local government maintenance activities.

<b>Maintenance activity</b>	<b>Page no.</b>
Maintenance activity No. 1: Street cleansing	66
Maintenance activity No. 2: Drain maintenance	68
Maintenance activity No. 3: Domestic waste and recycling collection	69
Maintenance activity No. 4: Council bin design and cleaning	69
Maintenance activity No. 5: Pavement repairs	70
Maintenance activity No. 6: Unsealed roads	71
Maintenance activity No. 7: Parks, reserves, golf courses and medians	72
Maintenance activity No. 8: Material storage	73
Maintenance activity No. 9: Plant and equipment	73
Maintenance activity No. 10: Unloading and loading areas	76
Maintenance activity No. 11: Building maintenance and construction	76
Maintenance activity No. 12: Graffiti removal	77
Maintenance activity No. 13: Emergency response	78

### **Maintenance activity No. 1: Street cleansing**

#### *Description*

Roads, carparks and footpaths make up approximately 70 per cent of urban impervious surfaces and are major areas of pollutant accumulation.

Street cleansing (usually sweeping) is a widely used practice to reduce accumulations of litter, dirt and vegetation from streets and footpaths. The primary purpose is to maintain attractive streetscapes, and large amounts are spent by municipalities annually. Street cleansing for stormwater quality improvement is usually a secondary consideration although sweeping is often claimed to improve stormwater quality.

There have been few investigations into the pollutant removal effectiveness of street cleansing. Some studies have concluded that street sweeping will achieve little in regard to stormwater quality improvement because of the small size of many street sediments, the frequency of rainfall, timing of sweeping practices with pollutant build-up and

unfavourable field conditions, such as parked cars blocking the streets and windy conditions (see Walker, Allison, Wong and Wootton 1999). Significant increases in expenditure on street cleansing aimed solely at improving stormwater quality may therefore not be effective. Other measures may be of greater benefit, for example litter traps or the frequency of street litter bin clearing.

There are a number of simple ways that existing street cleansing programs can be improved to maximise the benefits to stormwater quality. A series of best practice guidelines are presented below.

Improvements to stormwater quality are best achieved by focusing on 'hot-spots' rather than routine regular cleansing of all streets. Coordination and integration between street cleansing and other maintenance activities is also essential to maximise the benefits of street cleansing. Along with regular street cleansing programs, tailored programs should be provided to manage the additional impacts of specific maintenance, construction and other activities such as public events.

## Street cleansing: suggested measures

### Planning and monitoring

- *Program assessment*: review the emphasis and flexibility of cleansing programs to ensure there are adequate resources for targeted activities (hot-spots and special events).
- *'Hot spots' focus*: identify 'hot spots' where pollutants accumulate and target these during cleansing programs (e.g. commercial areas and construction sites).
- *Pit/pit trap cleansing*: identify opportunities to use street cleansing plant for alternative stormwater quality improvements such as pit/ pit trap cleansing.
- *Monitoring*: establish a data recording system, monitoring the areas cleaned and the quantities of material collected. Adjust the cleansing programs to maximise waste collection.

### Coordination with other activities

- *Activities audit*: assess all maintenance and operational activities to determine their potential to pollute (e.g. street cleansing prior to routine fire hydrant flushing).
- *Maintenance/cleansing*: ensure maintenance programs such as grass cutting or road repairs include appropriate street cleansing.
- *'One off' cleansing*: allow for 'one-off' cleansing operations during special events.

### Community coordination

- *Community information*: advise the community of street cleansing schedules to help clear the streets of cars during cleansing.
- *Off-peak cleansing*: tailor street cleansing schedules to ensure busy areas are swept during off-peak periods.
- *Restrict parking*: in areas of greatest pollution, install temporary parking restrictions to help clear these areas of vehicles during cleansing times.

### Operational restrictions

- *Discharge to drains:* do not permit street sweepers to discharge waste water or material into the drainage system.
- *Flushing and wash-down:* restrict washing of footpaths and flushing of kerbs, unless into a specifically designed storage/filtration system prior to entry into the stormwater system (see IMEA 1996).
- *Limited access areas:* where mechanical equipment access is limited, hand sweeping is preferred.



**Figure 6.1** Street sweeping.

### Maintenance activity No. 2: Drain maintenance

#### *Description*

Drainage maintenance includes inspection, cleaning and repair of open and piped drains, pits, litter traps and outfall structures.

Stormwater systems maintenance should be planned and coordinated to ensure excessive build-up does not occur. Frequent inspections of pollutant build-up 'hot spots' will help determine the most effective cleaning frequencies.

### Drain maintenance: suggested measures

- *Monitor:* via regular inspections, assess the accumulation rates of litter, silt, leaves and other pollutants in various parts of the drainage system.
- *Identify 'hot spots':* identify stormwater drain inlets/pits that require more frequent cleaning.
- *Plan cleaning frequency:* adjust drain cleaning frequency to suit pollutant accumulation rates.
- *Waste collection:* to collect waste material during drain cleaning, use machinery that does not sweep waste further into the drainage system (e.g. suction sweepers or hand sweeping and pick-up).

### **Maintenance activity No. 3: Domestic waste and recycling collection**

#### *Description*

Spillage during kerbside waste and recycling collections can contribute considerably to stormwater system pollution. The amount of spillage is affected by wind, rain and the type of collection system used.

The thoroughness of garbage collectors, recycled waste collectors and householders in the disposal/collection process also impacts on the spillage rate, as does the shape and size of the bin itself. Choose waste collection bins carefully—consider the container's potential to spill and the access it affords to scavenging animals.

#### **Domestic waste and recycling collection: suggested measures**

- *Collection vehicles:* use lifting and emptying mechanisms that minimise spillage risk.
- *Spillage policy:* collection contractors should only use dry methods to clean up spillage and should notify council of any spilled material not resulting from the collection operation.
- *Collection containers:* recycled waste collection containers should be fully enclosed, e.g. mobile garbage bins (MGB) for domestic recyclables.
- *Green waste:* if deposited on nature strips, green waste should be collected as soon as possible.
- *On-site chipping:* all residue from on-site chipping should be collected or swept.
- *Hard rubbish collection:* establish local laws prohibiting nature strip storage of hard rubbish for longer than seven days prior to the nominated collection date. Program hard rubbish collection to support this.

### **Maintenance activity No. 4: Council bin design and cleaning**

#### *Description*

The type of street and park litter bins used will affect the amount of litter reaching the stormwater system. Reference should be made to Waste Management Council, 1996, *Best Practices in Litter Management: A Guide for Local Government*, which provides good examples of bin selections, siting and emptying frequencies.

#### **City of Whitehorse contract clause example**

The City of Whitehorse has rendered its litter bin service. The following are extract clauses from its litter bin collection contract, which offer good examples of litter pollutant control:

##### **Street litter bins**

*Clearing of bins:* Contractor must empty litter bins at frequency specified in the schedule. Notwithstanding that a collection frequency for litter bins has been specified, the contractor must ensure that the litter bins are useable by the public at all times and that the volume of material in the litter bin never exceeds seventy-five per cent (75%) of the capacity of the bin.

*Spilt litter:* At the time of emptying the litter the contractor must clean up any spilt litter within a two metre radius of the litter bin whether the spillage was caused by the contractor or other causes.

### **Council bin cleaning: suggested measures**

- *Monitor use:* undertake audits to identify those bins most heavily used, particularly those near drainage pits and waterways. Schedule these for particular attention during cleaning programs.
- *Appearance:* select bins that look clean, attractive and are easily identifiable.
- *Design:* the aperture of the bin should be small enough to discourage illegal dumping, yet acceptable for normal litter.
- *Size:* bin size should be based on minimising emptying frequency while discouraging illegal dumping.
- *Locations:* bins should be located near the source of the litter (e.g. ATMs or fast food outlets).
- *Emptying:* the frequency of emptying should ensure that the bins do not overflow—typically, bins should not be more than 75 per cent full before clearing. The clearing contractor should be responsible for cleaning up litter within a specified radius of the bin.

### **Maintenance activity No. 5: Pavement repairs**

#### *Description*

Pothole patching, footpath maintenance, bitumen and concrete works are all potential sources of pollutants. These sources include bitumen overspray, concrete residues and pavement cutting dust. Pavement repair techniques should limit the generation of such pollutants.

‘Grinding’ is a technique used to ‘level up’ adjacent concrete slabs in a footpath. For small movements, this technique is preferred to slab replacement. Water is used for cooling during grinding, producing a fine particle residue. As a result, grinding work practices need to be reviewed to ensure minimal grinding ‘slurry’ reaches the storm-water system.

### **Pavement repair: suggested measures**

#### **Site preparation**

- *Side entry pits:* where there is a threat of material entering side entry pits, install temporary inlet filters.
- *Material storage:* material such as packing sand, gravel, crushed rock and excavated material should be stockpiled away from any drainage flow path and covered to prevent erosion (refer Construction activity No. 5: Materials storage).

#### **Bitumen work**

- *Spraying*: do not carry out bitumen spraying in windy conditions.
- *Screenings*: place only the required amount of screenings on bitumen.

#### **Concrete work**

- *Mixing*: concrete mixing and clean-up operations should be carried out in a designated area capable of containing excess water.
- *Concrete pumps*: provide appropriate protection to trap any spill material when using concrete pumps.
- *Concrete waste*: allow concrete waste and slurry to set before disposal off-site.
- *Concrete cutting*: waste water from brick and concrete cutting activities should be contained and either recycled or allowed to evaporate.

#### **Site clean-up**

- *General*: clean the site prior to leaving and remove all excess material including all waste concrete, packing material and soil.
- *Formwork*: remove any cover material and formwork from the site once concrete has cured.

### **Maintenance activity No. 6: Unsealed roads**

#### *Description*

Unsealed road maintenance involves grading, pothole patching and the re-sheeting of gravel or crushed rock pavements and shoulders. Reducing erosion and siltation is the key to best grading practices for unsealed roads.

The aim of grading operations should be to maximise the life of the pavement and reduce the need for grading. This will, in turn, minimise the risk of erosion and siltation. Selection of suitable pavement materials and proper compaction is a key factor in achieving this.

### **Unsealed roads: suggested measures**

- *Scheduling*: avoid grading when road surface is extremely dry. Time grading operations to coincide with peak road material moisture content. Complete grading operations on a daily basis.
- *Compaction*: use compaction equipment in conjunction with grading.
- *Filter strips and sediment traps*: ensure road run-off passes through a vegetated filter strip or sediment trap before discharging to a waterway.
- *Road materials*: where possible, use road materials that easily bind together and minimise contamination of run-off with fine particles. Chemical adjustment of road materials may also be feasible to reduce suspended sediment generation.
- *Slopes and crossfalls*: shoulder slopes should be 3–10 per cent. Pavement crossfall should generally be in the range of 3–8 per cent.
- *Table drains*: construct table drains in a 'U' shape to prevent scouring of inverts and divert outputs to ensure no direct connection to a waterway. Where table drains are likely to erode during stormwater flows, install energy dissipaters such as rubble or rock.

- *Temporary filters*: where sediment threatens to enter culverts, drains or side entry pits, install temporary filters.
- *Cut-off drains*: provide regular cut-off drains to minimise the potential erosion of road edges, particularly on steep grades.
- *Waterway crossings*: seal pavement and shoulders at waterway crossings wherever possible to limit erosion potential.

## **Maintenance activity No. 7: Parks, reserves, golf courses and medians**

### *Description*

Grass cuttings, leaves and prunings are all potential sources of stormwater contamination.

### **City of Manningham contract clause example**

The following are sample contract clauses suitable for reducing the effect of mowing activities:

'Prior to grass cutting all loose litter, rubbish or debris shall be cleared from the mowing area.' (Performance criteria: Absence of litter, rubbish or debris)

'All grass clippings and other debris to be swept or cleared from adjoining paths, gutters, paved surfaces and garden areas.' (Performance criteria: No clippings or other debris after cutting operations)

### **Parks, reserves, golf courses and medians: suggested measures**

#### **Planning and coordination**

- *Monitor*: monitor key pollution indicators for each park and garden (e.g. the number of people using the area, types of pollutants, proximity to waterways and so on).
- *Map*: determine the vegetation layout and the amount of open grassed areas adjacent to open waterways for each area. Encourage indigenous species to be planted that do not require slashing and also provide habitat and food for wildlife.
- *Maintenance methods*: determine, according to park activities, appropriate work practices to minimise pollution risks. Determine where specialist maintenance methods and equipment may be required and develop structural controls to trap pollutants.
- *Coordinate*: in areas adjacent to kerbs and channels, coordinate activities such as mowing or pruning with street cleaning operations.

#### **Grass cutting**

- *Preparation*: prior to grass cutting, remove litter and debris from the area.
- *Technique*: cut grass so that the mower throws the grass cuttings away from waterways, open drainage structure, kerbs and channels.
- *Cuttings removal*: at the completion of the day, sweep up all grass cuttings, leaves, prunings and so on left on paved areas—earlier if rain is imminent.

- *Areas adjacent to open waterways:* reduce grass mowing activities in these sensitive areas by either using indigenous grasses or replacing grasses with low ground cover.

#### **General park maintenance**

- *Plant selection:* along open waterways, choose plant species that are part of the food chain and add to the natural balance between flora and fauna—these generally require less maintenance and watering than exotic species.
- *Fertiliser:* use slow release organic fertilisers where possible. Avoid fertilisers in areas where wash-off can result in the fertiliser entering the drainage system.
- *Herbicides:* avoid spraying herbicides adjacent to open waterways or on windy days. Consider alternative weed control methods.
- *Mulch:* use mulch covers over garden areas to assist in absorbing and filtering water flows.
- *Ground cover:* use natural grasses and indigenous plants to reduce water needs and improve infiltration.

### **Maintenance activity No. 8: Material storage**

#### *Description*

Stockpiles of any uncompacted matter such as crushed rock, gravel, packing and brick-layers sand, loose timber, screenings or prunings can all contribute to stormwater pollution. Rainfall or water flowing through or over such stockpiles is the most immediate cause of this type of pollution.

#### **Material storage: suggested measures**

- *Storage location:* locate stockpiles on a paved surface, ideally on a high elevation site, with stormwater flow directed away from the site.
- *High risk materials:* toxic materials, hydrocarbons or materials rich in nutrients or metals must be stored either indoors or under cover.
- *Stockpile covering:* store materials under a roof, or with plastic or other suitably secured sheeting. Always store scrap metal under cover and regularly clear the stockpile from the site.
- *Non-roofed stockpiles:* non-roofed material storage areas should be designed to prevent direct run-off into the stormwater system.
- *Stormwater inlets:* ensure stormwater inlets are protected from stockpile spillages and leaks.
- *Site inspection:* inspect storage areas and liquid containers for damage or leaks at least every six months.

### **Maintenance activity No. 9: Plant and equipment**

#### *Description*

Plant and equipment can be sources of pollutants such as lubricants, coolants and fuels. Where possible, plant should be stored under cover. Where this is not practical, regular inspections and the use of drip pans are encouraged.



Washing and cleaning of plant can produce extremely high concentrations of pollutants. Appropriate wash water treatment and disposal systems must be installed in all 'wash-down' areas.

The following recommendations refer to the storage, refuelling and maintenance of council plant and equipment.

## **Plant and equipment: suggested measures**

### **Storage and storage areas**

- *Plant and equipment covering:* store vehicles and equipment under cover wherever possible (Figure 6.2).
- *Plant inspections:* program and record the results of regular plant inspections.
- *Parking plan:* designate parking areas for each vehicle to facilitate leak tracing.
- *Leakages:* develop procedures for reporting, repairing and cleaning up of leakages.

### **Cleaning plant and equipment**

- *Cleaning schedule:* clean plant regularly and routinely.
- *Wash-down areas:* provide designated 'wash-down' areas with appropriate run-off treatment (Figure 6.3).
- *On-site cleaning:* use grassed areas where on-site cleaning is required.
- *Signage:* install suitable signage, identifying specific area use and prohibiting oil and solvent disposals into the stormwater system.

### **Refuelling plant**

- *Area design:* use concrete paved areas—bitumen deteriorates as a result of fuel or oil spillage. The area design should contain all spills and ensure spillages cannot enter the stormwater system (Figure 6.4).
- *Spills:* clean up spills using 'dry' methods. Maintain a supply of dry clean-up material and directions for its use adjacent to or within the refuelling area.
- *Signage:* post signs to instruct operators not to 'top off' or overfill fuel tanks.
- *Inspection:* inspect fuel areas daily and identify any leakages.
- *Cleaning:* do not hose area during cleaning.

### **Vehicle maintenance**

- *Preferred location:* where possible, perform vehicular maintenance indoors.
- *Outdoor maintenance:* if performed outdoors, designate a specific area, keep it clean at all times and use dry clean-up practices. Ensure the site is correctly drained.
- *Drip trays:* keep drip trays or containers under the vehicles at all times during maintenance.
- *Drain:* drain fluids from any disused vehicles kept on-site for scrap or parts.



**Figure 6.2** A temporary storage facility, undercover and with a spoon drain to redirect surface flow (City of Manningham).



**Figure 6.3** A designated wash-down area at the City of Manningham's works depot. A paved, undercover area draining to a sump (City of Manningham).



**Figure 6.4** A fuelling area: paved, undercover area with a spoon drain to redirect surface run-off (City of Manningham).

## Maintenance activity No. 10: Unloading and loading areas

### Description

Unloading and loading areas are generally heavily trafficked, with a variety of goods and materials being moved about continually. The high degree of machinery operation married with the potential for spillages and breakages, present pollution risks in these areas.

### Unloading and loading areas: suggested measures

- *Location*: locate loading areas indoors where possible. Ensure stormwater flow is directed away from the loading area site.
- *Vehicle inspection*: transport vehicles should be continually checked for fluid leaks.
- *Spillage/leakage clean-up*: develop and implement procedures for the prompt clean-up of any spills. Drivers/operators should be responsible for any spillage due to their plant or operation.
- *High risk materials*: where high risk materials are handled, a treatment system for any spilt materials should be installed.

## Maintenance activity No. 11: Building maintenance and construction

### Description

Buildings generate a substantial amount of stormwater from their large roof areas. It is important that building stormwater systems are adequately maintained to minimise stormwater pollution.

Dust, paint, solvents, steel filings, timber residue and other wastes are all produced during building construction. Project or site managers must understand the nature of the materials they are working with and their potential to pollute stormwater.

The following simple practical maintenance techniques can reduce levels of building site stormwater pollution.

### Buildings: suggested measures

#### General building repairs

- *Materials storage*: store building materials under cover or in contained areas.
- *Site cleaning*: clean the repair or construction site daily. Do not use water for cleaning the site.

#### Painting and surface treatment

- *Leakage containment and treatment*: ensure paint or solvent leakages cannot enter the stormwater system. Treat a paint spill as a chemical spill.
- *Paint residue and dust*: use a ground cloth to collect dust and paint residue during scraping, sanding and painting.
- *Paint disposal*: clean water-based paint equipment where residue cannot enter stormwater system. Clean oil-based paint equipment where the waste material can be collected and disposed of as hazardous waste.
- *Spray painting*: avoid spray painting outdoors on windy days.



**Figure 6.5** Many building maintenance practices can pollute stormwater.

#### **Building drainage design and maintenance**

- *Design:* stormwater drains should be either connected directly into an appropriately designed stormwater system or routed over a suitably sized grassed area.
- *Inspection:* inspect building stormwater systems at least annually.
- *'Hot spots':* identify debris/sediment collection 'hot spots'. Program inspections and removal of materials to minimise the potential for debris accumulation.
- *Maintenance:* clean drain inlets, spouting, downpipes and pipes at least twice per year.

#### **Maintenance activity No. 12: Graffiti removal**

##### *Description*

Graffiti removal can result in toxic run-off, which can be washed into the stormwater system.

#### **Graffiti removal: suggested measures**

- *Waste water:* wash-down water and other materials resulting from graffiti removal should not enter the stormwater system.
- *Temporary filters :* fit temporary inlet pit filters, where required, to prevent pollutant entry.
- *Site clean-up:* sweep the site and dispose of any waste materials appropriately.

## **Maintenance activity No. 13: Emergency response**

### *Description*

All councils are required to prepare an emergency management plan (EMP), which identifies procedures for response to various types of emergencies. These procedures should include a response to stormwater incidents. The EMP should include a current drainage network plan showing the catchment boundary, all inlet points, direction of flow, location of outfalls and open waterways, and location of ecologically sensitive areas.

A number of organisations are responsible for dealing with spills and other pollution incidents. While the municipality's EMP should be followed by council officers encountering pollution incidents, the following guide will assist others to respond to such situations. In any emergency or pollution situation the primary objective must be to ensure safety and to contain pollution or prevent further spillage.

It is important to initiate established emergency response systems that are designed to deal with such situations. In most situations a single contact will be sufficient to initiate the appropriate emergency response.

Emergency services, Metropolitan Fire Brigade or Country Fire Authority should be notified in the event of a chemical or hazardous substance spillage. This may be the first call in the event of a serious incident.

Where drainage systems are affected, the 'owner' or 'manager' of the system should be notified. For local drains this will be the municipality. Larger drains and waterways are usually the responsibility of the waterway authority—in Melbourne and surrounding areas this is Melbourne Water; in regional Victoria this may be the responsibility of the regional Catchment Management Authority.

EPA should be notified, either directly or via the EMP, of pollution incidents involving the discharge of waste material to the stormwater system. This notification is in addition to notification of the asset owner/manager and will initiate action to address the pollution source.

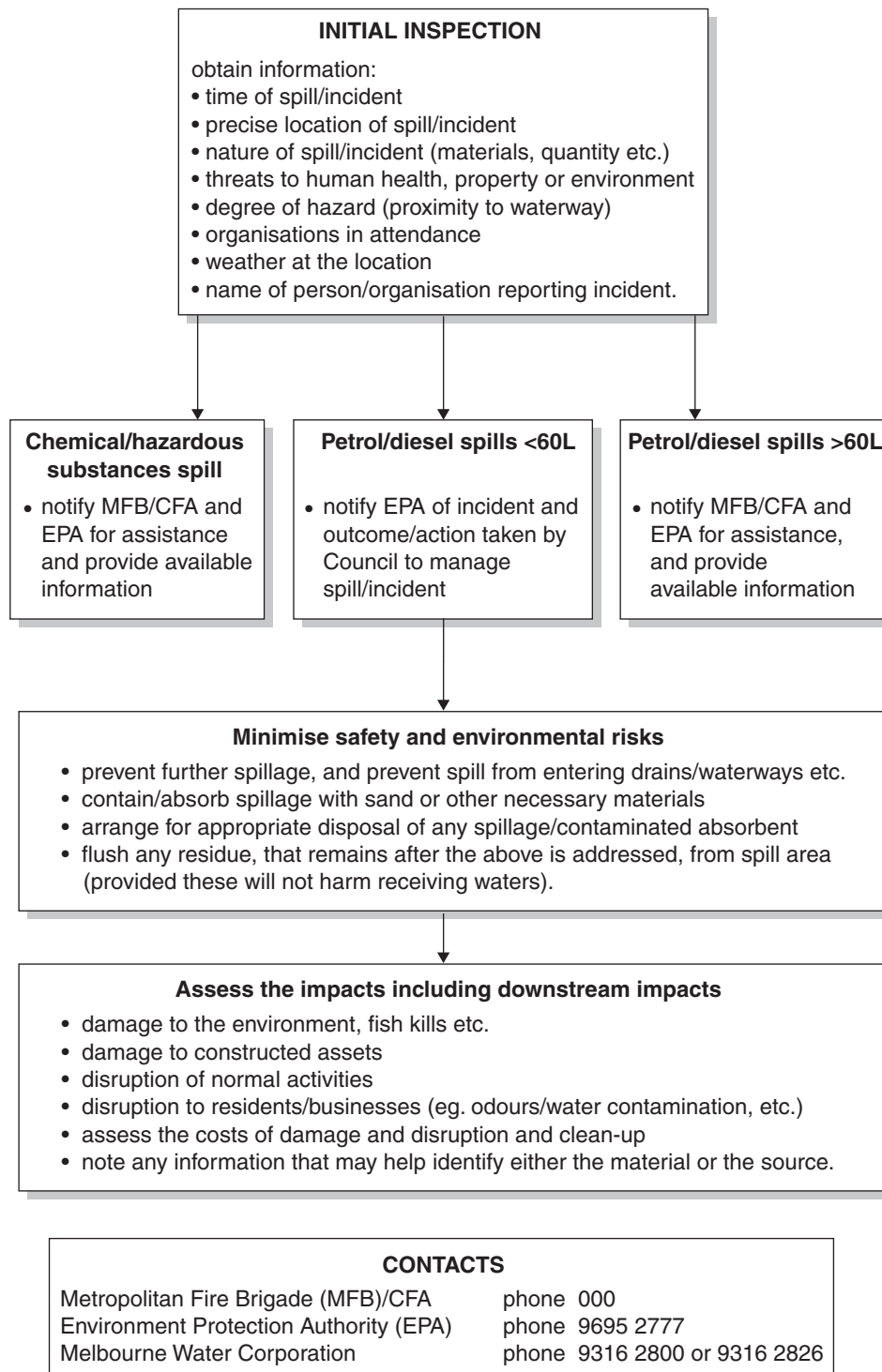
Spills to the environment often involve fuels and oils from vehicle accidents. As emergency services have standard procedures for dealing with fuel spills, it is not necessary to notify EPA of such incidents except when the spill is greater than 60 litres.

A number of organisations are responsible for dealing with pollution spills. Figure 6.6 is a guide for responding to spill incidents and determining what action to take.

### **6.2.3 Training and staff awareness**

---

Improved stormwater quality is largely dependent on the comprehension, acceptance and adoption of best practices by municipal staff. Staff training in these practices will assist implementation. The following systems can be developed to establish and maintain staff knowledge and awareness:



\* Melbourne Water Corporation or the relevant Catchment Management Authority also need to be notified where their drains or waterways are affected.

**Figure 6.6 Responding to spill incidents.**

- *staff work groups*: these provide effective forums for the review of current work practices and the development of appropriate new work practices;
- *performance indicators*: develop a range of key work practice performance indicators to be used in work group reviews;

- *routine monitoring programs*: train staff to routinely check activity procedures and their effect on stormwater pollution;
- *work practice audits and training*: periodically audit employee work practices and regularly review work performance and implement training; and
- *contract inclusions*: write contracts that clearly instruct sub-contractors to work in accordance with these guidelines.

#### 6.2.4 Council source control checklist

The following checklist can assist council staff to identify and address any aspects of council operational activities that may affect stormwater quality. The checklist can be used to refer back to the relevant sections within the Guidelines which provide further information on these issues. Section 6.3.3 provides a checklist that could be used to assess site management plans for construction activities.

The checklist is divided into two parts.

- *Part A* deals with the *planning of construction and maintenance activities*. This should be completed at the planning stage of each project/contract and can be referred to when writing specifications.
- *Part B* describes *maintenance activities* that potentially impact on stormwater quality. Choose the section that is relevant to a particular activity and use the checklist to ensure that all aspects of the activity that may affect stormwater quality are considered.

<b>Part A: Planning asset construction and maintenance</b>	<b>Maintenance activity or section number</b>
<p>Do the works have the potential to affect stormwater quality? if yes:</p> <p>A1: Maintenance planning</p> <ul style="list-style-type: none"> <li>▪ Can alternative measures be used (e.g. grass cutting: use alternative species, use grass catchers)?</li> <li>▪ Can clean-up measures be employed during the works (e.g. street sweepers following grass mowers)?</li> </ul> <p>A2: Construction planning</p> <ul style="list-style-type: none"> <li>▪ Is the site larger than one hectare?</li> </ul> <p>if yes:</p> <ul style="list-style-type: none"> <li>– You need to develop site management plan. See the checklist in Section 6.3.3</li> </ul> <p>if no:</p> <ul style="list-style-type: none"> <li>– Are mitigation measures required on-site (e.g. open bin or skip, hay bales or silt fences on boundary, prompt revegetation of site, prevent sediment export from vehicles)?</li> <li>– Are the measures suggested appropriate?</li> </ul>	<p>Section 6.2.1</p> <p>Section 6.3.3</p>

<b>Part B: Maintenance activities</b>	<b>Maintenance activity or section number</b>
<p><input type="checkbox"/> Pavement repairs                      Ensure that:</p> <ul style="list-style-type: none"> <li>- measures are taken to prevent pavement material from entering the stormwater system; and</li> <li>- all materials are removed from the site when work is completed.</li> </ul>	<p>Maint. activity No. 5                      Maint. activity No. 8                      Maint. activity No. 9                      Maint. activity No. 10                      Section 6.2.4</p>
<p><input type="checkbox"/> Unsealed roads                      Ensure that:</p> <ul style="list-style-type: none"> <li>- measures are taken to minimise erosion and siltation;</li> <li>- suitable road material is used;</li> <li>- thorough compaction of road material is performed; and</li> <li>- works are timed to reduce the risk of erosion and siltation.</li> </ul>	<p>Maint. activity No. 6                      Maint. activity No. 8                      Maint. activity No. 9                      Maint. activity No. 10                      Section 6.2.4</p>
<p><input type="checkbox"/> Street cleansing                      Ensure that:</p> <ul style="list-style-type: none"> <li>- programs have been developed to cater for 'hot spots';</li> <li>- an auditing program is implemented to allow revision of cleansing schedules;</li> <li>- the cleansing program is coordinated with other council activities;</li> <li>- operators of street cleansing machinery and equipment are well trained;</li> <li>- refuelling, loading, vehicle maintenance and wash-down areas are equipped with structures to prevent pollutants from entering the stormwater system;</li> <li>- routine inspections and maintenance are performed for all equipment and plant; and</li> <li>- training procedures are put into place for staff in regard to accidental spills and disposal of waste from cleansing equipment.</li> </ul>	<p>Maint. activity No. 1</p> <p>Maint. activity No. 8</p> <p>Maint. activity No. 9                      Maint. activity No. 10                      Section 6.2.4</p>
<p><input type="checkbox"/> Drainage maintenance                      Ensure that:</p> <ul style="list-style-type: none"> <li>- regular inspection and maintenance programs are performed;</li> <li>- auditing programs are in place to assess if the maintenance schedule is being followed;</li> <li>- appropriate machinery is being used;</li> <li>- refuelling, loading and vehicle maintenance areas are equipped with structures to prevent pollutants from entering the stormwater system;</li> <li>- routine inspection and maintenance programs for equipment and plant are implemented; and</li> <li>- staff are trained to deal with accidental spills and maintenance of the drainage system.</li> </ul>	<p>Maint. activity No. 2</p> <p>Maint. activity No. 8                      Maint. activity No. 9                      Maint. activity No. 10                      Section 6.2.4</p>
<p><input type="checkbox"/> Domestic waste, recycling and council bin collection                      Ensure that:</p> <ul style="list-style-type: none"> <li>- appropriate vehicles and receptacles are being used for waste collection to minimise pollutants/waste materials entering the stormwater system;</li> <li>- staff are trained in appropriate best practice techniques to minimise spillages;</li> <li>- collections are frequent enough to minimise spillages/loss of materials entering the stormwater system;</li> <li>- an auditing process is established to ensure that collection frequency is maintained as specified on schedules and spillages, or other losses are minimised;</li> <li>- local laws have been developed to discourage illegal dumping or poor litter management by local businesses and residents (e.g. building sites, commercial areas);</li> <li>- refuelling, loading and vehicle maintenance areas are equipped with structures to prevent pollutants from entering the stormwater system;</li> <li>- an inspection and maintenance schedule for equipment and plant is implemented; and</li> <li>- staff are trained to deal with accidental spills during collection of waste and recyclables.</li> </ul>	<p>Maint. activity No. 3</p> <p>Maint. activity No. 8                      Maint. activity No. 9                      Maint. activity No. 10                      Section 6.2.4</p>



<p><input type="checkbox"/> Parks, reserves, golf course and median strips</p> <p>Ensure that:</p> <ul style="list-style-type: none"> <li>- appropriate management practices are conducted to minimise grass, leaves and prunings from entering the stormwater system;</li> <li>- the type of vegetation planted increases infiltration;</li> <li>- appropriate fertilisers are used and operators are trained in appropriate application techniques;</li> <li>- refuelling, loading and vehicle maintenance areas are equipped with structures to prevent pollutants from entering the stormwater system;</li> <li>- routine inspections and maintenance are performed on all equipment and plant; and</li> <li>- staff are trained so their actions minimise the impact on stormwater quality.</li> </ul> <p><input type="checkbox"/> Building maintenance and construction</p> <p>Ensure that:</p> <ul style="list-style-type: none"> <li>- materials are stored under cover;</li> <li>- building and cleaning wastes are not disposed of into the stormwater system; and</li> <li>- staff are trained in stormwater quality best practice techniques.</li> </ul> <p><input type="checkbox"/> Graffiti removal</p> <p>Ensure that:</p> <ul style="list-style-type: none"> <li>- no toxicants are washed into the stormwater system; and</li> <li>- staff are trained in stormwater quality best practice techniques.</li> </ul> <p><input type="checkbox"/> Emergency response</p> <p>Ensure that:</p> <ul style="list-style-type: none"> <li>- A response plan for spills has been incorporated into council's emergency response plan.</li> </ul>	<p>Maint. activity No. 7</p> <p>Maint. activity No. 8                  Maint. activity No. 9                  Maint. activity No. 10                  Section 6.2.4</p> <p>Maint. activity No. 8                  Maint. activity No. 9</p> <p>Maint. activity No. 10                  Maint. activity No. 11                  Section 6.2.4</p> <p>Maint. activity No. 12                  Section 6.2.4</p> <p>Maint. activity No. 13</p>
--	---

## 6.3 Construction activity

Construction activity can be divided into two phases. The land development phase and the building phase. Both of these phases are known to result in serious stormwater pollution unless managed appropriately.

### Land development stage

Land development involves making undeveloped land suitable for urban uses through land forming and provision of services such as roads, drainage, water supply, sewers, electricity and gas. Land development usually involves major earthworks resulting in significant potential for contamination of stormwater by eroding soils (Figure 6.7).

### Building stage

Building construction can result in significant soil disturbance as well as contaminate stormwater with building wastes. Pollutants can include litter, rubble, concrete mixer waste, paints, plaster, brick sand, cleaning products and imported soils, etc (Figure 6.8).



**Figure 6.7** Land development results in significant vegetation removal and soil disturbance.

Effective source control measures employed during construction can greatly minimise the impact of both phases of construction activity on stormwater quality. Site management plans are an effective means of planning and implementing measures to minimise the generation of pollutants from construction activities.

This section discusses the issues involved with both phases of construction and provides some best practice measures that can reduce pollutants reaching the stormwater system. General guidelines for developing a site management plan are also included.

A checklist illustrates the steps involved in the planning process and a range of controls are described that can be applied in site management plans. More detailed design guides for site control measures can be found in NSW Department of Housing, 1998, *Managing Urban Stormwater: Soils and Construction*.



**Figure 6.8** Building construction waste.

### 6.3.1 Site management plans

---

For building and development works on areas larger than one hectare a site management plan is recommended. The plan should include:

- a description of measures to mitigate pollution threats to stormwater;
- recommendations that can be followed easily and used on-site (usually including A1 size plans); and
- a commentary that describes the development of the plan.

The purpose of the plan is to ensure that effective soil and water management is an integral part of construction works.

For sites smaller than one hectare, the objective of stormwater quality protection remains the same. Most of the pollution control tools are equally applicable to small sites, although more emphasis on building waste management is necessary. The checklist in Section 6.3.3 can be used to ensure that adequate provision has been given to pollution control on-site even if not presented in a formal plan.

#### Site management plan objectives

Site management plans aim to minimise the generation and export of sediment and other pollutants resulting from construction activities. Generally this can be achieved through:

- coordination of erosion controls with construction activities, including the staging of works;
- minimising soil exposure during construction;
- hasty and extensive revegetation works;
- effective management of water on to, within and from a site;
- provision of suitable access tracks and loading, unloading, maintenance and wash-down areas;
- effective litter management and 'house-keeping' practices;
- employing sediment capture techniques for large sites; and
- a flexible plan that can incorporate unexpected changes in the design or severe weather conditions.

NSW Department of Housing (1998) presents extensive practical techniques for developing a site management plan and provides details of measures that can be employed to manage erosion and sediments on site.

It is recommended that all site management plans have, as a minimum, the following features:

- 1 *Set of drawings* clearly showing the site layout and features and locations of erosion control works and other measures to minimise pollution.
- 2 *A narrative* accompanying the plans to describe how erosion and sediment control measures were chosen and their maintenance requirements.
- 3 *Background information* including site boundaries, contour maps, existing vegetation, location of site access and other impervious areas and existing and proposed drainage pathways with discharge points also shown.
- 4 *Program of works* containing details on the nature and specific location of works (revegetation, cut and fills, run-off diversions, stockpile management, access protection), timing of measures to be implemented, and maintenance requirements (extent and frequency).
- 5 *Engineering details* outlining methodologies for each control measure, with supporting engineering calculations for all proposed sediment basins, constructed wetlands, GPTs, etc. Details should include procedures for construction and maintenance requirements as well as the predicted performance of each measure.

Section 6.3.3 contains a checklist for developing and assessing site management plans.

### **6.3.2 Source controls for construction activities: index**

---

There are a number of simple ways to minimise pollution from construction sites. Significant improvements can be achieved with careful planning and coordination between construction activities and control measures.

The following eight source control measures highlight the main concepts for reducing pollution from construction sites.

<b>Construction activity</b>	<b>Page no.</b>
Construction activity No. 1: Erosion control	86
Construction activity No. 2: Sediment collection	87
Construction activity No. 3: Site water control	88
Construction activity No. 4: Equipment storage and maintenance	88
Construction activity No. 5: Materials storage	88
Construction activity No. 6: Litter control	89
Construction activity No. 7: Building activity	90
Construction activity No. 8: Wash-down practices	90



**Figure 6.9** Exposed soils and unprotected drainage lines can erode readily.

### **Construction activity No. 1: Erosion control**

#### *Description*

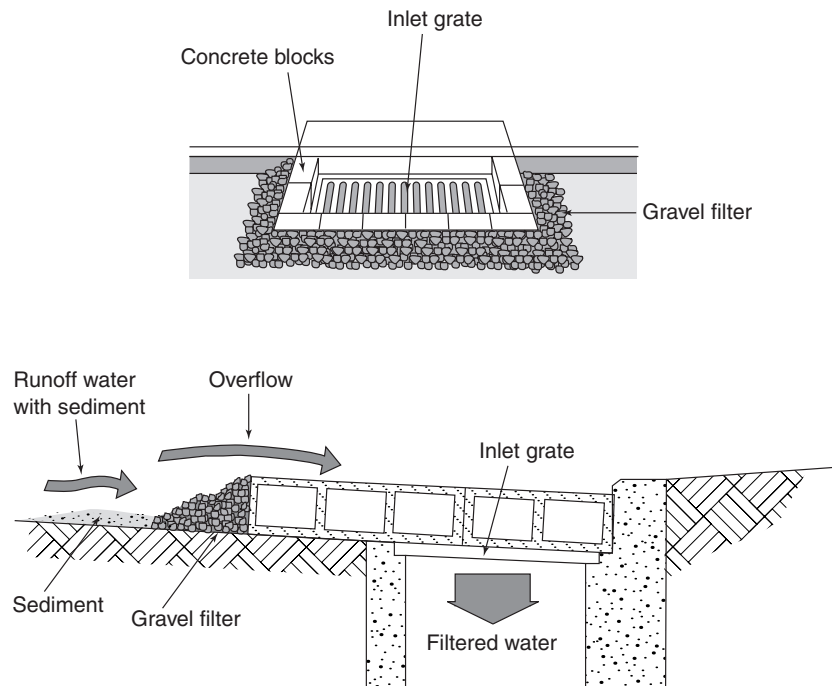
During construction, site clearing leaves soil exposed and it can be easily eroded. The following list provides a guide to preventing erosion on construction sites.

#### **Erosion control: suggested measures**

- *Programming*: install erosion control measures before construction commences. Schedule construction activities to minimise land disturbance.
- *Land clearing*: minimise the extent and duration of land clearing.
- *Site access*: limit and control site access and, where possible, use permanent roads rather than temporary access tracks. Ensure temporary access roads are stabilised.
- *Services*: coordinate the provision of site services to minimise disturbance.
- *Stockpiles*: locate stockpiles away from concentrated flows and divert run-off around them.
- *Stormwater and run-off systems*: install temporary drains and minimise concentrated water flows. Control stormwater velocity where necessary with temporary energy dissipater structures. Divert run-off around trench excavations or disturbed areas.
- *Rehabilitation*: revegetate or stabilise all disturbed areas as soon as possible.



**Figure 6.10** Stabilisation and revegetation protect soils from erosion.



**Figure 6.11** Block and gravel filter.

## Construction activity No. 2: Sediment collection

### *Description*

If erosion does or is likely to occur on a site, sediment export is an inevitable result. The following measures may be employed to capture the sediment and reduce the amount of sediment that leaves the site.

### *Sediment collection aims*

- to minimise the generation of dust, litter and debris within the site;
- to introduce a regular site maintenance schedule; and
- to install sediment control devices to capture mobilised sediment.

### **Sediment control: suggested measures**

- *Grass filter strips* : these encourage sediments to settle as water passes over a vegetated area.
- *Sediment filters* : these use materials such as fine mesh or geofabric to filter run-off prior to discharge.
- *Sediment traps*: temporary sedimentation basins.
- *Temporary side entry pit filters* : small removable structures that prevent sediment entering kerb inlets (such as a block and gravel filter shown in Figure 6.11).
- *Drop inlet filters* : such as straw bales and silt fences, which prevent sediment entry to the drainage system.

### **Construction activity No. 3: Site water control**

#### *Description*

Managing the collection and flow of stormwater on a construction site is a key factor to minimising erosion and sediment export.

#### **Site water control: suggested measures**

- *Plan and prepare:* identify drainage lines and control measures to treat estimated stormwater volumes and sediment loads.
- *Water diversion:* to reduce run-off over exposed areas, re-direct water using diversion earth banks and catch drains. Prevent water from running over cut or fill batters. Provide piped or lined drains if this cannot be avoided.
- *Temporary drains:* build temporary drains as short as possible and do not connect directly to waterways.
- *Erosion prevention:* minimise the quantity of stormwater entering disturbed areas. Use grass or rock beach drains to prevent scouring and energy dissipaters to break up high velocity flows.
- *Bridge facilities:* provide properly constructed vehicular crossovers for crossing waterways.
- *Maintenance:* implement site inspections, maintenance and cleaning programs.

### **Construction activity No. 4: Equipment storage and maintenance**

Refer Section 6.2.2, Maintenance activity No. 9: Plant and equipment.

### **Construction activity No. 5: Materials storage**

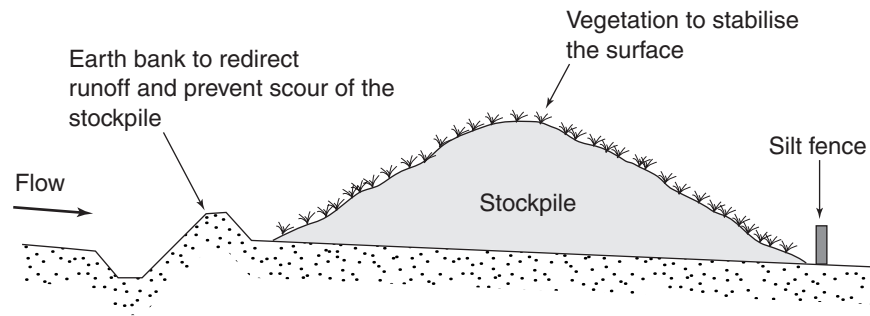
#### *Description*

Stored material that has been poorly located or left unprotected can be a source of pollutants.

#### **Materials storage: suggested measures**

- *Stockpile location:* locate stockpiles and other material storage away from drainage lines and at least ten metres from waterways.
- *Stockpile construction:* minimise the number and size of stockpiles. Construct stockpiles with a height to width ratio less than 2:1. Surround unstabilised stockpiles and batters with silt fences or drainage systems that will collect and treat contaminated water.
- *Stockpile maintenance:* cover any stored material to protect it from rainfall. Mulch, roughen and sterile grass seeding can be used on any batter or topsoil stockpile that is to be maintained for longer than 28 days.

See Figures 6.12 and 6.13.



**Figure 6.12 Stockpile management.**



**Figure 6.13 A silt fence around a stockpile.**

## Construction activity No. 6: Litter control

### Litter control: suggested measures

- *Litter storage and housekeeping*: maintain a high standard of housekeeping. Store all litter carefully so it cannot be washed or blown into the stormwater drainage systems.
- *Rubbish bins*: provide bins for construction workers and staff at appropriate locations, particularly where food is consumed.
- *Daily site clean-up*: clean up site of all litter daily.
- *Rubbish disposal*: dispose of scrap materials (e.g. off-cuts and scrap machinery components) in a responsible manner.
- *Staff education*: conduct ongoing staff awareness programs, reinforcing the need to avoid littering.

Local laws can also be an effective way to control litter on construction sites. Clauses from such laws can be included in contracts to specify appropriate litter management practices.



## Local law examples

'The builder must provide an on-site container to dispose of wind blown refuse for the duration of the building work. The bin must not be allowed to overflow.' (City of Casey).

'When carrying out building works on your premises make sure you have the necessary permits and have organised suitable waste collection for all building waste.' (City of Melbourne, as part of promotional campaign to clean up laneways within the city)

### Construction activity No. 7: Building activity

Refer to Section 6.2.2, Maintenance activity No. 11.

### Construction activity No. 8: Wash-down practices

#### *Description*

Building activities such as concrete delivery and pouring, masonry cleaning, grinding and demolition, and painting, can all involve wash-downs during clean-up. Unmanaged, these activities can contribute many pollutants to stormwater. It is therefore imperative to ensure that all wash-down run-off is contained on-site.

## Wash-down: suggested measures

- *Designated areas*: providing designated wash-down areas that deliver wash-down wastes away from the stormwater system.
- *Containment*: contain wash-down run-off on site by using holding basins to prevent entry to the stormwater system.
- *Temporary filters* : fit temporary inlet pit filters near wash-down areas to prevent pollutant entry to the drainage system.
- *Spillage/leakage clean-up*: develop and implement procedures for the prompt clean-up of any spills.
- *Site clean-up*: sweep wash-down areas regularly to prevent additional pollutants being mobilised.

### 6.3.3 Site management plan checklist

---

The following checklist can be used to help develop a site management plan or to assess that adequate measures for stormwater protection will be implemented on a proposed development. The checklist highlights the key components and considerations that a site management plan should incorporate.



## 6.4 Business surveys

---

Some business activities have significant potential to pollute the stormwater system. For example:

- commercial areas are known to generate high levels of litter;
- industry can contaminate stormwater through poor control of industrial processes, or the transport, handling and storage of goods;
- food preparation businesses may have poor facilities for waste handling and disposal; and
- the motor vehicle repair industry uses and produces many materials with potential to seriously contaminate stormwater and pollute waterways.

Responsibility for dealing with these pollution generating activities rests with the managers of the business enterprise. Education backed up by enforcement is the best means of ensuring business managers are aware of their potential to pollute and have knowledge of the measures available to minimise pollution risks.

Surveying business operations is an effective means for determining the extent and nature of activities with the potential to pollute and therefore targeting education and enforcement programs appropriately. The remainder of this section presents a methodology and checklist for conducting surveys of businesses that have the potential to pollute urban stormwater.

Education is a key tool for addressing stormwater pollution generated by business. Methods for developing education programs, a range of educational tools and examples of proven programs are presented in Section 6.5.

### 6.4.1 Stormwater pollutant surveys

---

The purpose of a survey is to identify business activities that are potentially generating pollutants likely to affect stormwater quality. Surveys can be used to help target pollution reduction programs (e.g. to locate a treatment measure or target an education program) or can be used to assess the performance of a program to improve business practices. The survey process itself can also be used to raise awareness amongst business operators of their potential to pollute.

#### **Business surveys**

Business surveys are a useful tool for determining the nature and extent of activities with the potential to pollute local waterways. A survey can be carried out by face-to-face or telephone interview or mailed question sheets. Surveys can be targeted (specific area or industry), random (a certain number of enterprises within an area), or representative (enterprises

selected as being representative of a broader group). The checklists in the next section can form the basis of a survey questionnaire. Development of a survey program should be carried out in conjunction with the local operations group of the EPA. Local Waterwatch groups or other community groups may also be able to assist carrying out surveys.

### Water quality assessment

Another way of surveying activities that affect stormwater quality is through water quality monitoring. Data collected from water quality monitoring can be used to isolate catchments that contribute high concentrations of pollutants. Some pollutants are indicative of specific problems and these data can be used to isolate the problem and then perform a detailed investigation to locate the source (e.g. high levels of E. coli in drains indicate the presence of faecal contamination and an illegal sewer connection to the stormwater system is a possible cause).

Water quality monitoring data are collected by EPA in Victoria and in Melbourne by Melbourne Water. These organisations can provide data and also advise on water quality monitoring methods and equipment. The Waterwatch Program is also a way of involving the community with a water quality monitoring program.

More detailed investigations can involve remote videos or plumbing inspections in the drainage network to identify pollution sources. However, these methods are costly and time consuming. Before considering such investigations it is recommended that an initial survey (using the checklists) of problem areas is undertaken to appreciate the extent and nature of the problem and to assess whether a more detailed investigation is warranted.

#### 6.4.2 Stormwater quality checklists for businesses

The checklist presented in this section is designed to evaluate a range of business related activities for their potential to pollute and can be used as the basis for questionnaires. Use of the checklists will help identify the nature and extent of those activities. This will assist the development and targeting of management programs.

<b>Introductory questions</b>	
1 Are paved areas ever cleaned?	if yes, go to: Section 1
2 Are any materials stored outside?	Section 2
3 Is material delivered onto the premises?	Section 3
4 Can packaging become litter?	Section 4
5 Does the business produce waste?	Section 5
<b>1 Pavement cleaning/ wash-down areas</b>	<b>Notes</b>
<ul style="list-style-type: none"> <li>▪ Are paved area wastes swept and picked up for disposal?</li> <li>▪ Are appropriate chemicals used for cleaning?</li> <li>▪ Are clean-up wastes prevented from entering gutters/drains/stormwater system?</li> <li>▪ Is litter the only waste likely to be generated on pavements?</li> <li>▪ Are there designated wash-down areas?</li> <li>▪ Is all plant maintenance performed in contained areas?</li> </ul>	

<p><b>2 Material storage and spill control</b></p> <ul style="list-style-type: none"> <li>▪ Are storage containers regularly checked for leakages and storage levels?</li> <li>▪ Are outside storage areas contained (e.g. bunding) to prevent any materials reaching the stormwater system?</li> <li>▪ Are they protected from vandals/pests/water?</li> <li>▪ Are there contingency plans for spills/escape of stored materials?</li> <li>▪ Are staff trained in spill procedures regularly?</li> <li>▪ Are high risk areas isolated from the drainage system?</li> </ul>
<p><b>3 Delivery and transfer</b></p> <ul style="list-style-type: none"> <li>▪ Are there designated delivery areas?</li> <li>▪ Are delivery areas under cover and protected from run-off?</li> <li>▪ Are delivery areas regularly inspected and cleaned?</li> <li>▪ Are spill capture boxes used to contain spills on-site?</li> <li>▪ Are loads covered when leaving the premises?</li> <li>▪ Are there spill control procedures in place, and are staff trained?</li> </ul>
<p><b>4 Litter management</b></p> <ul style="list-style-type: none"> <li>▪ Are areas that generate litter regularly cleaned?</li> <li>▪ Are bins provided for customers/staff?</li> <li>▪ Are the paved areas surrounding the premises regularly cleaned to remove litter?</li> <li>▪ Have sources of litter been identified?</li> <li>▪ Have litter management measures been reviewed recently?</li> </ul>
<p><b>5 Waste storage and disposal</b></p> <p><b>Waste storage and collection</b></p> <ul style="list-style-type: none"> <li>▪ Are stored wastes protected from escape during high winds or rain?</li> <li>▪ Is the storage area isolated from the stormwater system?</li> <li>▪ Should material escape the storage container, will it be contained on-site?</li> <li>▪ Are waste containers always emptied before reaching capacity?</li> <li>▪ Are waste collections regularly monitored to ensure no escape?</li> <li>▪ Is the contractor required to clean-up after collection?</li> <li>▪ Are storage containers protected from vandals and pests?</li> </ul> <p><b>Waste discharges</b></p> <ul style="list-style-type: none"> <li>▪ Are all wastes prevented from entering the stormwater system?</li> <li>▪ Are there diversion or containment systems to prevent stormwater contamination?</li> <li>▪ Are systems regularly inspected or tested?</li> <li>▪ Are staff trained in their operation?</li> </ul>

## **6.5 Education programs**

Education is a key source control tool for dealing with activities carried out within residential households and business premises which have the potential to contaminate stormwater run-off. Individually these activities may seem insignificant. Given the number of households in urban areas (in Melbourne 70 per cent of the urban area is residential, or approximately 1.5 million homes), the total impact on stormwater quality can be very significant.

In many cases simple changes in attitude and behaviour can vastly reduce pollution of stormwater from domestic activities. This section describes a methodology for developing effective education and awareness programs for stormwater pollution. This includes a number of education tools and examples of successful programs.

### 6.5.1 Developing an education program

---

#### Why education programs are appropriate

Education is a most appropriate and effective strategy for minimising stormwater pollution for many reasons, including:

- **targeting diffuse sources:** the 'diffuse source' nature of the stormwater pollution problem means that structural solutions are often less effective than education.
- **targeting the individual:** the behaviour of individuals at home and work greatly influences stormwater quality. By targeting home and work practices, great improvements can be made.
- **whole community impact:** education has the capacity to mobilise the whole community and can therefore have a major effect on stormwater quality.
- **linking opportunity:** education provides the opportunity to clearly link individual behaviour and water quality.
- **a major motivator:** simple messages such as 'stormwater flows untreated into our rivers and oceans' is a major motivator for appropriate behaviour.

Education should be an integral part of any stormwater management program. Best results will be achieved when education is used to support a range of regulatory, policy and economic mechanisms.

An education program is not an isolated set of activities; it is a number of integrated activities targeting different people for particular purposes.

#### Developing an education program

Effective community education requires a thorough understanding of the

- environmental issues;
- audience;
- behaviour targeted; and
- best ways to achieve an improved environment.

### Objectives

When planning an education program, consideration should be given to both short and long term objectives.

**Short term objectives**

**To improve the understanding of:**

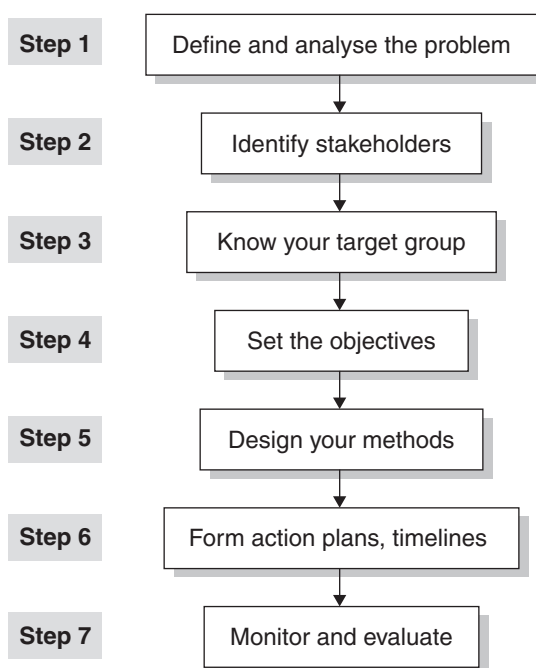
- how the streets, the stormwater system, rivers and oceans are interconnected; and
- how daily activities affect stormwater quality.

**Long term objectives**

- to encourage a true sense of responsibility for, and appreciation of, urban waterways.

### The development process

There are seven key steps in planning an effective community education program. Figure 6.14 shows the steps in the process.



**Figure 6.14 Stages of developing an effective community education program.**

#### Step 1: Define and analyse the problem

This is best achieved by breaking the stormwater pollution problem down into component parts. It is essential to determine the sources of pollution and who impacts on these sources.

#### Step 2: Identifying stakeholders

Identifying who has a stake in the issues and involving them in the project planning and delivery will help ensure success. Stakeholders can be defined according to many crite-

ria. These can include geographical region, ethnic background, socio-economic group, age group, occupational group, special interest groups or behavioural or attitudinal sectors within the broader community.

There are a number of stakeholders that may affect stormwater quality. These include:

- 1 **Commercial businesses and industry:** for example shopping centres, the construction industry and the car repair industry. Many of these businesses are represented by industry associations.
- 2 **Land holders and residents:** for example local residents, farmers, local environmental and community groups.
- 3 **School/youth groups.**
- 4 **Municipal staff.**

### **Step 3: Know your target group**

Precise identification of the target group is essential in developing a quality community education program.

Knowing the target group means much more than simple identification. It requires development of a complete profile, so that the most effective communication methods can be identified. This can include demographic information such as age, gender, socio-economic status and level of education.

### **Step 4: Set objectives**

Once the issues and the target groups are identified, specific program objectives can be set. The objectives indicate the awareness, understanding or attitudes that are targeted.

Identify one or two simple key messages to communicate these objectives to the target audience. These messages can be categorised as follows:

- 1 **Informative messages:** these convey facts. For example, '90 tonnes of dog faeces is produced each year in metropolitan Melbourne'.
- 2 **Feeling messages:** these get people emotionally involved in an issue. For example, 'plastic bags in waterways can kill or injure animals'.
- 3 **Responsibility messages:** such messages appeal to a person's sense of what is right or proper. For example, 'people in the car industry should be using the sewerage system and not the drainage system to dispose of car wash effluent'.
- 4 **Empowering messages:** a message to empower people to act. For example, 'individual actions, no matter how small, do make a difference'.



- 5 **Action messages:** these advise people of how they can become directly involved. For example, 'don't wash paint brushes in the sink. Dispose of excess paint by wiping it on newspaper, wash the brush with water then poured the water on your lawn or garden'.

### **Step 5: Design your methods**

The most successful programs use techniques specifically designed for the target audience. Determine which education tools and techniques are likely to work most effectively with a particular target group.

A mixture of techniques may increase the chances of success. Finally, you will need to check that there is an appropriate balance between tools which inform and those which facilitate action. More about tools later in this chapter.

### **Step 6: Form action plans and timelines**

Planning the education program requires consideration of costing, timelines, distribution, approvals and briefs. The plan guides all project activity and should be revisited often during the project.

#### *Costing*

Identify initial and recurrent costs including staff, ongoing costs and the possibility of any potential income. There are a number of factors to consider when costing a project including:

- 1 **Funding sources:** what possible sources of funding are there beyond one organisation. Are there any 'in-kind' opportunities?
- 2 **Sponsorship:** is sponsorship from the commercial/ industrial sector possible?
- 3 **'Trim to fit':** how can the project be modified if sufficient funds are not found?

### **Step 7: Monitor and evaluate**

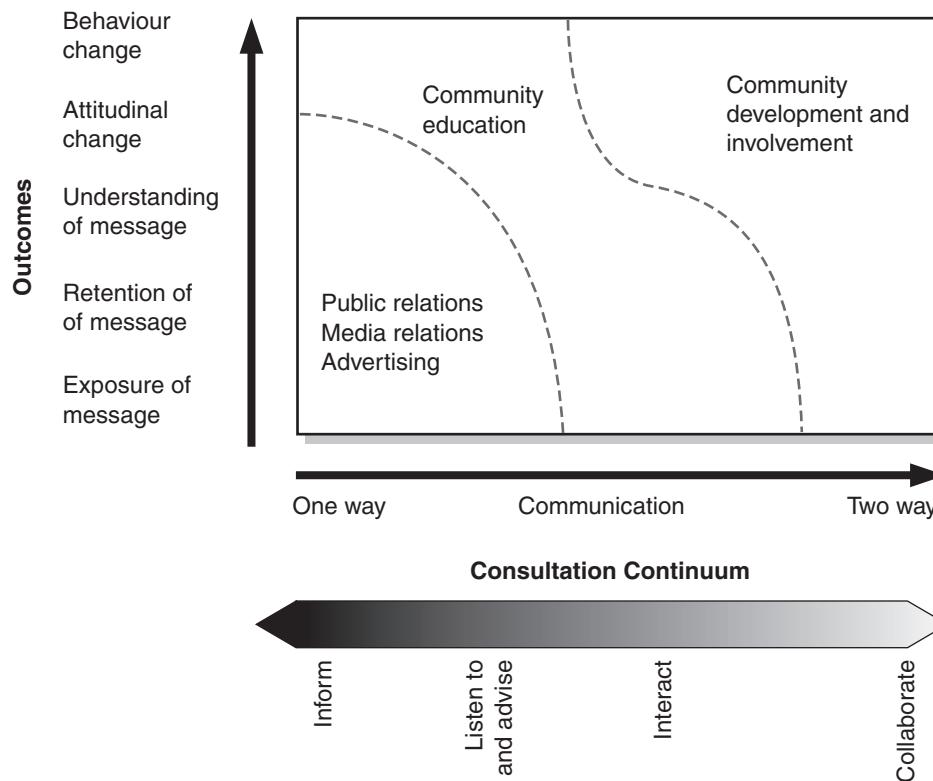
This requires the collection of information and records to show the effectiveness of the project. This is often the most difficult step and is too often neglected.

Audit review questions might include:

- 1 Did the message(s) reach the audience to the extent expected? How is this known?
- 2 Were the message(s) understood?
- 3 Were the expected outcomes reached? Did behaviour change?

### **Linking programs**

A broad infrastructure of stormwater and environmental education programs and resources exists to help in program development.



**Figure 6.15 The communication model.**

- 1 **Local programs:** integrate stormwater quality programs into existing local programs run by council or other agencies.
- 2 **External programs:** link in with an existing programs in other municipalities around the state or country.
- 3 **Advisory groups:** involve focus or advisory groups in the development of education programs.

### **Tips for effective communication**

Community education messages need to be communicated clearly from the outset. The following are suggestions for effective communication:

- 1 **Clear and concise:** provide a clear, concise and consistent message describing how the target audience contributes to storm water quality programs and how it can reduce its impacts.
- 2 **Plain English:** use everyday language. Use external reviewers to reduce the use of technical terms, acronyms and jargon.
- 3 **Simple messages:** break up complicated subjects into smaller more simple concepts. Present these concepts in a metered and organised way, to avoid 'overloading' and confusing the audience.

- 4 **Link messages:** ensure each message clearly relates to the last in the sequence.
- 5 **Foreign languages:** translate your messages into the foreign languages within your community. Ensure that cultural differences are considered when messages are translated.
- 6 **Check correctness:** make sure all messages have a sound, up-to-date technical basis.

The communication model shown in Figure 6.15 illustrates how behavioural changes are best achieved through two way, collaborative communication.

## 6.5.2 Educational tools and techniques: index

---

Most individuals require exposure to the same message many times before becoming conscious of it.

Given limited resources, the question therefore is not which one medium is best, but which mixture of media can deliver optimal results.

This section presents a range of tools that can be used to develop educational programs. These are then illustrated in a number of case studies.

<b>Education tool</b>	<b>Page no.</b>
Education tool No. 1: Printed material	100
Education tool No. 2: Media	101
Education tool No. 3: Signs	101
Education tool No. 4: Community programs	101
Education tool No. 5: Display	101
Education tool No. 6: Community water quality monitoring programs	101
Education tool No. 7: Launches	102
Education tool No. 8: Local action committees and groups	102
Education tool No. 9: Consumer programs	102
Education tool No. 10: Business programs	102
Education tool No. 11: School education programs	102

### **Tool 1: Printed material**

#### *Description*

Simple residential information sheets can quickly become monthly or quarterly publications containing a variety of stormwater quality information. Such publications should incorporate program logos and slogans, so that the material is easily associated with other program material and the program in general.

#### *Examples*

Newsletters, fact sheets, brochures and posters.

## **Tool 2: Media**

### *Description*

Selected media activities can offer widespread publicity and the opportunity to relay the messages repeatedly.

### *Examples*

Press releases, advertising and public service announcements.

## **Tool 3: Signs**

### *Description*

Billboards and council vehicles present another opportunity for relaying a message related to stormwater.

## **Tool 4: Community programs**

### *Description*

There is a wide choice of community-based programs available, ranging from simple drain stencilling through to clean-up days and establishing 'friends' groups to look after particular areas. All offer huge potential to work with the community and its resources.

The short lead time and low maintenance costs of a storm drain stencilling program makes it an attractive activity for local communities (see Case study 1).

### *Examples*

Storm drain stencilling, community clean-up days.

## **Tool 5: Displays**

### *Description*

Direct contact between municipal staff and the public can provide an excellent opportunity to relay the importance of stormwater management.

Environmental booths may be set up at special functions and festivals, or during periods of particular environmental significance; for example Arbour Day, National Water Week or World Environment Week (see Case study 2).

## **Tool 6: Community water quality monitoring programs**

### *Description*

Encouraging community participation in environmental monitoring programs provides an excellent means of 'hands-on' education.

In Victoria, three highly successful water quality monitoring programs have adopted this approach: Waterwatch, Community Streamwatch and Beachwatch. All are excellent community water quality monitoring programs, which have been interlinked into other programs throughout Victoria (see Education program examples 3, 4 and 5).

### **Tool 7: Launches**

#### *Description*

Attracting public attention through a launch is a great way to boost the profile of an education program. Guest speakers can be incorporated into the launch program to communicate important issues.

### **Tool 8: Local action committees and groups**

#### *Description*

A number of councils around Victoria are using committees as a means of developing and coordinating stormwater programs. Examples include the Darebin Creek Coordinating Committee and Merri Creek Management Committee (see Case studies 6 and 7).

### **Tool 9: Consumer programs**

#### *Description*

Point of purchase displays and other programs that provide information to consumers about waste provide an effective means of waste management. These raise environmental consciousness at the prime source of packaging waste.

#### *Examples*

Grocery bags with logos and slogans, environmental ratings of products, consumer information.

### **Tool 10: Business programs**

#### *Description*

Many businesses have the potential to cause stormwater pollution. Education efforts can be focused on these 'priority' business groups. Small businesses, in particular, need assistance with understanding the problems of stormwater pollution and how to improve practices.

Successful business programs that have been run in Victoria include the Considerate Business Program which targeted local shop traders (see Case study 6), and the Local Motor Vehicle Repair and Services Industry Program (see Case study 8). A certification program can be initiated to ensure developers and contractors meet best practice standards. This process ensures a minimum competence level has been achieved and that stormwater pollution prevention plans are in place.

#### *Example*

Workshops and publications, business charters, environmental ratings of businesses.

### **Tool 11: School education programs**

#### *Description*

Developing environmental awareness from an early age is an effective long term means of changing community behaviour and attitude.

Councils have been most effective in developing local environmental education programs for schools. The Plenty River Discovery Program is an example of a program designed by local councils for school education (see Case study 9).

When developing a school education program, 'fun' is the key element. Start with the key environmental messages, then design fun and exciting activity programs to relay these message.

Facility tours of a wastewater treatment plant or a municipal waste collection centre, or contests to develop posters and calendars, are examples of fun ways to develop children's awareness of stormwater issues.

It is important to discuss the program with school teachers, to determine their needs and how the environmental education program may fit into the school curriculum.

There are a number of current programs that can be incorporated into education schedules. These include Community Streamwatch or Waterwatch for water quality sampling or drain stencilling.

#### *Existing programs and providers*

For councils lacking the resources or time to put together an education project, an education provider may be an alternative option. The *Environmental Education Contacts Directory 1997* available from the Victorian Association of Environmental Education, provides a comprehensive listing of education providers throughout Victoria.

There are a variety of education providers offering environmental programs, which local councils can promote to local schools. Some examples include the Gould League



**Figure 6.16** A typical drain stencil message.

(Moorabbin), CERES (East Brunswick) and Scienceworks (Spotswood). Councils may choose to support or promote school attendance at these programs as a positive approach to environmental education.

The following programs can easily be promoted by local government to schools:

- Catchment Connections (refer to Case study 10),
- Beach Secrets: Marine Program (refer to Case study 10),
- Bay Litter Watch Program: An Environmental Project, conducted by the Gould League (refer to Case study 10),
- Drain Watch and Waterways Watch (refer to Case study 11),
- Rain and Drain Chemistry: Atmospheric and Stormwater Pollution (refer to Case study 12).

### 6.5.3 Examples of education programs

This section presents a range of education programs used around Victoria.

<b>Drains to the Bay: A Water Pollution Kit</b> <b>CASE STUDY 1</b> <b>Melbourne Water</b>	
Target audiences	Years three to six primary school students
Objectives	To develop an integrated education program on stormwater pollution, meeting teachers' needs and linking in with the Victorian curriculum and standard framework.
Approach	The Drains to the Bay kit is used to create an awareness of the stormwater pathway, the pollutants that are picked up, the impact of these pollutants and how we can reduce the problem. The kit can be adapted by teachers to form the basis of their own water pollution program, or they can follow the format and activities supplied.
Support material	<p>The kit contains a 10-minute animated video and a 50-page teacher's booklet, which includes over 32 activities and background notes.</p> <p>Stencilling kit: the stencilling of pollution messages on side entry pit covers or nearby footpaths is a key activity described in the kit. Stencil kits reading 'Care about the Bay—Litter Washes Away' have been provided to Rotary clubs for distribution to program participants.</p> <p>For bayside municipalities a dolphin is incorporated in the stencil, so that children and adults can associate marine wildlife with stormwater pollution. Councils that lie further inland prefer to use a platypus in their stencil designs to make the association with local waterway habitat.</p>
Achievements	<ul style="list-style-type: none"> <li>▪ Over 700 education kits have been sold since 1992.</li> <li>▪ The drain stencilling program in Melbourne has been extended through a partnership between Melbourne Water and Rotary. Since September 1995, 50 rotary clubs have become involved, purchasing around 100 Drains to the Bay school education kits to pass on to local primary schools.</li> <li>▪ The Cities of Manningham, Wyndham, Maroondah, Banyule, and the Shire of Melton have also purchased kits. These have been passed on to local community groups and schools.</li> <li>▪ The program achieved finalist status in 1993 Australian Teachers of Media (AToM) Awards.</li> <li>▪ The Brighton Rotary Club was awarded the 1994–95 Rotary International Significant Achievement Award for its involvement in the Drains to the Bay Program.</li> </ul>
Contact details	Further information can be obtained by contacting Melbourne Water on (03) 9235 7100, or Rob Tucker of Brighton Rotary on (03) 9555 0522.

<b>Envirofest: A Community Education Awareness Festival</b> <b>CASE STUDY 2</b> Cities of Manningham, Banyule, Nillumbik; Parks Victoria and Eco-Recycle	
Target audience	Local community
Objectives	It is hoped that visitors to the festival develop a greater understanding of environmental issues and how their actions can be changed for the better.
Approach	Adopting a different environmental theme each year, Envirofest is an annual event held at Westerfolds Park in Templestowe. It attracts more than 10,000 people from across Melbourne. The festival is held on the first Sunday in June to coincide with World Environment Week.
Requirements	<ul style="list-style-type: none"> <li>▪ Local schools are asked to participate in environmental education projects, all of which are displayed on the day.</li> <li>▪ In 1997, 17 early childhood centres from around the area participated in the Drains to the Bay Program. Children from each centre were supplied with stencilling kits, which were modified to include a platypus figure—a locally familiar symbol, which provides a ready association with the local waterways.</li> <li>▪ The centres were encouraged to use plant- or animal-based detergents or soaps rather than those based on photochemicals.</li> </ul>
Achievements	With the backing of three municipalities surrounding Westerfolds Park in 1996, Envirofest became a truly regional festival. The cities of Banyule and Nillumbik joined the city of Manningham as major sponsors.
Contact details	Further information on this project can be obtained from Pam Pagigiotis (City of Manningham) on (03) 9840 9362.

<b>Waterwatch: Waterway Community Monitoring Program</b> <b>CASE STUDY 3</b> Department of Natural Resources and Environment	
Target audience	Local community
Objectives	<ul style="list-style-type: none"> <li>▪ To increase community awareness and understanding of water quality issues.</li> <li>▪ To increase community involvement in management decisions affecting the water resource.</li> <li>▪ To encourage collaboration between the community and the resource managers.</li> <li>▪ In the long term, to generate useful data for community and agency use, complementing data presently collected by agencies' monitoring networks.</li> </ul>
Approach	The community monitoring networks comprise community groups and schools, acting in partnership with local resource management agencies to: <ul style="list-style-type: none"> <li>▪ monitor environmental and water quality in their catchment;</li> <li>▪ share data throughout the catchment;</li> <li>▪ detect catchment environmental problems;</li> <li>▪ jointly develop appropriate action; and</li> <li>▪ assess and review catchment-based management plans and activities.</li> </ul>
Requirements	Anyone with an interest in monitoring and water quality issue can participate (e.g. Landcare groups, community organisations, school groups and so on).
Support material	A range of material is available on request: manuals, equipment and so on. Waterwatch also has an internet site <a href="http://www.vic.waterwatch.org.au">http://www.vic.waterwatch.org.au</a> .
Problems and issues	Throughout Victoria, a wide range of individuals and groups participate in Waterwatch. These include landholders and water authorities, through to primary and secondary students. <p>In conjunction with their local water authority or agency, groups develop their own Waterwatch Program based on a wide range of catchment environmental issues. The partnership determines a monitoring program, ensures that quality assurance and control occurs, feeds results back to the water managers and develops appropriate follow-up actions.</p>



	The Waterwatch Program currently collects information about:
Achievements	<ul style="list-style-type: none"><li>▪ stream or wetland habitats,</li><li>▪ biological monitoring for macro-invertebrates, algae and E. coli, and</li><li>▪ monitoring of temperature, pH, turbidity, nutrient content (nitrogen and phosphorous), dissolved oxygen, conductivity and flow rate.</li></ul> <ul style="list-style-type: none"><li>▪ Over 500 monitoring groups are currently involved, supported by more than 90 partners and program sponsors.</li><li>▪ Waterwatch was the winner of the Australian Financial Review/Telstra 1996 Internet Award.</li></ul>
Contact details	Contact Waterwatch Victoria on (03) 9412 4663 or (03) 9412 4072.



**Figure 6.17** Students conducting water quality sampling as part of Waterwatch. (Photo courtesy of Waterwatch Victoria (DNRE))



**Figure 6.18** The Camel Trek entourage taking water quality samples along the Goulburn River from the junction of the Goulburn and Murray rivers to Eildon Weir. One of the many unique monitoring activities conducted as part of the Waterwatch Program. (Photo courtesy of Waterwatch Victoria (DNRE))

**Melbourne Waterwatch: A Community Water Quality Monitoring Program for the Port Phillip Region (formerly Community Streamwatch)**

**CASE STUDY 4**  
**Melbourne Water**

Target audiences	<ul style="list-style-type: none"> <li>▪ Local community</li> <li>▪ School groups</li> </ul>
Objectives	To develop a schools and community waterway monitoring network that in turn becomes the advocate for behavioural change among the wider community.
Approach	<p>Schools: a hands-on learning project with real world outcomes. Students become teachers and communicators. Groups work in partnership with local councils and Melbourne Water.</p> <p>Groups: an opportunity for groups to demonstrate the improvements they have made with revegetation and educational projects.</p>
Requirements	<ul style="list-style-type: none"> <li>▪ Any school or group can join the Melbourne Waterwatch mailing list and be part of its annual 'Snapshot'.</li> <li>▪ Intending participants should liaise with their local council conservation officer who in turn will contact Waterwatch staff.</li> </ul>
Support material	<ul style="list-style-type: none"> <li>▪ Manuals</li> <li>▪ Monitoring kit</li> <li>▪ Free training days</li> <li>▪ Internet site</li> <li>▪ Videos</li> <li>▪ Sponsorship tool kit</li> <li>▪ Local coordinators are employed by councils and provide day-to-day support for Waterwatch groups.</li> </ul>
Achievements	<ul style="list-style-type: none"> <li>▪ A Melbourne-wide network.</li> <li>▪ A high degree of publicity and support.</li> <li>▪ A \$400,000 wetland area constructed at Newport with corporate sponsorship.</li> </ul>
Contact details	Further information can be obtained by contacting Melbourne Water on (03) 9235 2100.

**Beachwatch: A Community Beach Monitoring Program for Port Phillip Bay**

**CASE STUDY 5**  
**EPA**

Target audiences	<ul style="list-style-type: none"> <li>▪ All beachgoers</li> <li>▪ Local bayside communities</li> <li>▪ Residents of urban catchments around Port Phillip Bay</li> <li>▪ Media</li> </ul>
Objectives	<ul style="list-style-type: none"> <li>▪ To provide a regular information service about beach conditions and water quality around Port Phillip Bay during summer.</li> <li>▪ To focus people's attention on our beaches.</li> <li>▪ To raise community awareness about the causes of beach pollution, especially stormwater pollution.</li> </ul>
Approach	<ul style="list-style-type: none"> <li>▪ Throughout the summer, volunteer Beachwatchers report on beach conditions, including stormwater outlets, while the EPA monitors beach water for E. coli levels.</li> <li>▪ Information is provided to the public via a regularly updated phone service. This information is also placed on the internet and regularly distributed to media. Any problems with stormwater outlets are mentioned.</li> <li>▪ The Beachwatch Program maintains a high media profile over the summer months.</li> </ul>

Support material	<ul style="list-style-type: none"> <li>▪ EPA also advises councils of any reports of concern about beaches and stormwater outlets. When applicable, EPA investigates any reports of pollution from stormwater outlets. This occurs throughout the year.</li> <li>▪ EPA information bulletins are issued annually, providing an overview of beach conditions and water quality during the summer. These emphasise the major impact of stormwater pollution on beaches in Port Phillip Bay, and provide positive tips on 'what you can do'.</li> <li>▪ Posters, billboard advertising, T-shirts and suncaps are also used to promote the program.</li> </ul>
Problems and issues	<ul style="list-style-type: none"> <li>▪ Focus will be increased on 'community involvement' rather than information services.</li> <li>▪ Volunteer Beachwatchers will be engaged in 'community monitoring' of beaches and stormwater outlets, as per other successful catchment management community education programs.</li> <li>▪ Other information products or services will be developed, e.g. radio reports.</li> </ul>
Achievements	<p>Since 1991, the Beachwatch Program has contributed to a heightened awareness of:</p> <ul style="list-style-type: none"> <li>▪ the potential health risks of swimming in bacteriologically contaminated water,</li> <li>▪ the fact that such contamination results from urban pollution via our stormwater system.</li> </ul>
Contact details	Melinda Nutting, EPA Customer Service, on (03) 9695 2700.

<p><b>Considerate Business Program</b>  <b>CASE STUDY 6</b>  <b>Merri Creek Management Committee, City of Moreland</b></p>	
Target audience	Local shop traders
Objectives	<ul style="list-style-type: none"> <li>▪ To create awareness of the relationship between the stormwater system and litter pollution in waterways.</li> <li>▪ To promote litter waste minimisation with traders.</li> <li>▪ To provide traders with appropriate litter and waste minimisation information and advice.</li> </ul>
Approach	<ul style="list-style-type: none"> <li>▪ Audits were conducted to determine the source of existing problems in the shopping district.</li> <li>▪ Extensive shop owner interviews were carried out, advising each of best practice methods for waste disposal and shop front maintenance.</li> <li>▪ Literature describing stormwater pollutant sources and their effects was provided.</li> <li>▪ Community awareness was developed through the Litter Sisters mime act, performed on trams throughout the area. The performance provided a particularly novel and successful means of getting the message across. This component of the project was fully funded by the City of Moreland with support from the Public Transport Commission (PTC).</li> </ul>
Requirements	<ul style="list-style-type: none"> <li>▪ A 'fee for service' scheme.</li> <li>▪ Traders who participated in the program were given an accreditation certificate and window sticker for display.</li> <li>▪ Customers were encouraged to use calico bags instead of plastic.</li> </ul>
Support material	<ul style="list-style-type: none"> <li>▪ List of appropriate recyclable waste collectors.</li> <li>▪ Stickers and certificates.</li> </ul>
Problems and issues	Timing and cost.
Achievements	The number of Sydney Rd, Brunswick and Coburg trader memberships increased from 52 in 1994, to 132 in 1996.
Contact details	Merri Creek Management Committee Education Officer, on (03) 9380 8199.

<b>Environmental Education Program for Schools</b> <b>CASE STUDY 7</b> <b>Merri Creek Management Committee</b>	
Target audience	Primary and secondary school students years three to seven, school management, staff and parents.
Objectives	<ul style="list-style-type: none"> <li>▪ To encourage an appreciation of the unique character of the Northern Yarra catchment waterways.</li> <li>▪ To create an awareness of the environmental impacts of land management practices on local waterways over time.</li> <li>▪ To achieve a change in attitude and behaviour in regard to litter and water pollution.</li> </ul>
Approach	<p>A whole school community approach is adopted, using theatrical performance as a stimulus. The program is also hands-on, interactive and curriculum focused.</p> <p>Topics:</p> <p>Understanding your Local Waterway—a performance, creek walk and support materials exploring:</p> <ul style="list-style-type: none"> <li>▪ geological history, catchment and landforms;</li> <li>▪ indigenous people, their culture and land-use practices;</li> <li>▪ European settlement and land-use practices;</li> <li>▪ indigenous flora and fauna; and</li> <li>▪ weeds and feral animals.</li> </ul> <p>Water Pollution and Litter—a performance, drain stencilling activity and support material exploring:</p> <ul style="list-style-type: none"> <li>▪ the difference between the stormwater and sewerage systems;</li> <li>▪ the connection between the stormwater system and local waterways; and</li> <li>▪ the environmental impacts of floatable litter and water pollution. Sources of litter and what we can do about them. This involves an in-school student letter audit, report and recommendations.</li> </ul>
Requirements	Fee for service, class time provisions, access to a local waterway plus school administration and teachers' support.
Support material	A school program promotional video. Topic based on curriculum standard framework, with teacher's background information, graphic material and activities. In addition, publications such as <i>The Disappearance of the Spineless Bug</i> , <i>Creek Life</i> and <i>Plants of the Merri Merri</i> are also available.
Problems and issues	Timing program integration within a predetermined curriculum and timetable. Financial barriers in respect to performance cost (\$3.50 per student)—this can discourage some schools from full involvement in the program.
Achievements	The program has been successfully piloted to 8 schools in the northern suburbs in 1996. Working with 17 schools in the cities of Darebin and Hume in 1998.
Contact details	Merri Creek Management Committee Education Officer, Phone on (03) 9380 8199.

<b>Local Motor Vehicle Repair and Services Practices</b> <b>CASE STUDY 8</b> EPA Dandenong, City of Greater Dandenong, Melbourne Water	
Target audience	Local motor vehicle industry
Objectives	<ul style="list-style-type: none"> <li>▪ To minimise the presently large amounts of industry wastes being discharged to stormwater drains and creeks—particularly Dandenong Creek.</li> </ul>
Approach	<ul style="list-style-type: none"> <li>▪ Provide good information to motor trade describing EPA recommended waste disposal and handling requirements.</li> <li>▪ Liaise with City of Greater Dandenong.</li> <li>▪ Write to TAFE colleges conducting motor trade courses and provide them information describing recommended waste disposal methods.</li> <li>▪ Conduct an enforcement action campaign.</li> </ul>
Requirements	Specifically to: <ul style="list-style-type: none"> <li>▪ cease the discharge of wash waters from detergent and degreaser washing of vehicles and paints to stormwater; and</li> <li>▪ encourage the installation of properly built wash basins (connected to sewers) where necessary.</li> </ul>
Support material	<ul style="list-style-type: none"> <li>▪ EPA Publication No. 462</li> <li>▪ Dandenong Council Industry advice kit</li> </ul>
Problems and issues	Around 1000 premises must overcome a traditional attitude to automotive waste disposal and the stormwater system—that stormwater drains are merely a waste disposal facility.
Achievements	A gradual acceptance of EPA standards by the automotive industry.
Contact details	Ken Taylor, EPA Dandenong on (03) 9794 0876.

<b>Plenty River Discovery Program</b> <b>CASE STUDY 9</b> Banyule City Council	
Target audience	School students
Objectives	To promote the natural values of the river environment and increase community awareness of requirements for its protection.
Approach	<ul style="list-style-type: none"> <li>▪ Involve local students in studies of the Plenty River environment, including assessment of habitat values and water quality monitoring.</li> <li>▪ Incorporate a high level of community involvement in revegetation and restoration activities along the river.</li> <li>▪ Promote the program through local media, displays and restoration activities.</li> <li>▪ Integrate Plenty River studies with school course material.</li> <li>▪ Prepare a report on project outcomes.</li> </ul>
Support material	<ul style="list-style-type: none"> <li>▪ Integration of Melbourne Waterwatch with these studies.</li> <li>▪ Establishment of the Plenty River Discovery internet site through schools.</li> <li>▪ Plenty River display materials.</li> </ul>
Problems and issues	<ul style="list-style-type: none"> <li>▪ Poor water quality in Plenty River resulting from urban run-off.</li> <li>▪ Particular problem pollutants are litter and sediment.</li> <li>▪ Extensive weed infestations along the river.</li> <li>▪ Poor access to and community awareness of the Plenty River.</li> </ul>
Achievements	<ul style="list-style-type: none"> <li>▪ Extensive class studies undertaken by Montmorency Secondary College students on the Plenty River.</li> </ul>

Contact details	<ul style="list-style-type: none"> <li>▪ As part of this program, the college's years 8 and 10 science students are collecting data and information on the river and its environment. This includes information on its fauna, indigenous plants, weeds, habitat, geology, regional history, sources of litter and other pollutants. Melbourne Waterwatch has been incorporated into the program as the water quality monitoring component. The surveys will not only give the students a greater understanding of the existing eco-system, but will provide important information on human and animal impacts on our waterways.</li> <li>▪ Involvement of schools and the Friends of Plenty River in revegetation activities.</li> <li>▪ Media articles in the <i>Herald-Sun</i>, local press and school newsletters.</li> <li>▪ Displays at Banyule festival and Envirofest.</li> <li>▪ The Plenty River Discovery Report.</li> </ul> <p>City of Banyule on (03) 9490 4222.</p>
-----------------	--

<b>Catchment Connections</b> <b>CASE STUDY 10</b> The Gould League of Victoria, Melbourne Water	
Target audience	School students
Objective	To provide a range of learning programs for school students. Three programs are available; one program for preps to year two students, and two programs for high school students—one hands-on and the other internet-based.
Approach	<ul style="list-style-type: none"> <li>▪ Prep to year two program: children participate in an interview with 'King Neptune'. He or she is concerned about litter and other pollutants being washed into the bay. Children discover the wildlife around the beach and rock pools that need protection.</li> <li>▪ High school students' program: students are provided with activities at the Gould League and along the coast and Mordialloc Creek.</li> <li>▪ High school internet project: this uses the resources found on the internet to examine the impact of litter on the coast and sea.</li> </ul>
Requirements	Bookings are required with Gould League for the two practical programs. Connection to the internet is preferable for the internet project, but a shorter, printed copy can also be mailed. Participants may want to use a neighbouring beach as their monitoring site.
Support material	<ul style="list-style-type: none"> <li>▪ The Gould League has a permanent display.</li> <li>▪ Groups receive a teacher's activities pack with relevant CSF links.</li> <li>▪ Equipment is provided to students to discover life forms along the beach and the rock platform.</li> <li>▪ Internet site <a href="http://www.shnet.edu.au/gould/gould.html">http://www.shnet.edu.au/gould/gould.html</a></li> <li>▪ A free <i>Catchment Connections</i> booklet is available while stocks last.</li> </ul>
Problems and issues	<ul style="list-style-type: none"> <li>▪ The program focuses on urban waste draining into creeks, rivers and the sea.</li> <li>▪ Students identify that items washed down drains cause problems in the sea.</li> <li>▪ Students build model litter traps.</li> <li>▪ Beach litter is surveyed and counted.</li> <li>▪ Creek water is monitored for pollutants.</li> </ul>
Achievements	<i>Catchment Connections</i> allows students to examine the global issues of littering in the sea. The project provides an innovative approach to educating students about litter.
Contact details	Bob Winters at the Gould League on (03) 9532 0909.

## Drain Watch and Waterways Watch

### CASE STUDY 11

CERES

Target audience	School students
Objectives	<ul style="list-style-type: none"> <li>▪ To provide experimental environmental education programs about stormwater management and related issues.</li> <li>▪ To provide hands-on, interactive teaching and learning about, in and for the environment.</li> <li>▪ To present the environmental, social and economic aspects of the waterways pollution problem.</li> </ul>
Approach	<ul style="list-style-type: none"> <li>▪ Drain Watch (for primary students)</li> </ul> <p>A program focusing on stormwater and sewerage, creek pollution (particularly rubbish), habitat (weeds and vegetation), birds and animals. Students explore changes along the Merri Creek, see the open stormwater drain and the MCMC litter trap, then investigate where the rubbish comes from. Students discover ways to protect the creek environments.</p> <ul style="list-style-type: none"> <li>▪ Waterways Watch (for secondary students)</li> </ul> <p>A unit investigating water testing on the Merri Creek. Stream quality is related to geomorphology and land-use variations (including the use of the creek as a stormwater channel). Physical, chemical and biological indicators and habitat surveys are used to measure the health of the Merri Creek. This program includes a wide variety of physical and chemical tests (e.g. temperature, pH, phosphates, nitrates, chlorides, dissolved oxygen), plus transects and sketch mapping. Specialised equipment is available on-site.</p>
Requirements	<ul style="list-style-type: none"> <li>▪ Bookings are essential and there is a small charge.</li> <li>▪ The minimum group size is 20.</li> <li>▪ Drain Watch can be a half or full day program.</li> <li>▪ Waterways Watch is usually a full day program.</li> </ul> <p>All equipment is supplied, including physical and chemical tests, transect equipment, nets, buckets, microscopes and dishes, aquatic species, identification charts, maps and data graphs.</p>
Support material	All participating groups receive 'post-visit kits', continuing posters and brochures. Groups participating in the Waterways Watch Program receive a specially written booklet.
Problems and issues	CERES Education needs funding to retain its qualified teaching staff and equipment maintenance.
Achievements	In 1996, 3000 students participated in the programs.
Contact details	Contact Eric Bottomley, Education Manager or Cinnamon Evans, Co-ordinator of Environmental Studies on (03) 9387 2609 or (03) 9387 4472.

## Rain and Drain Chemistry: Atmospheric and Stormwater Pollution

### CASE STUDY 12

Melbourne Water, Science Teachers Association of Victoria, EPA

Target audience	School students
Objective	To help students understand that a knowledge of chemistry is essential in solving some of our most serious environmental problems.
Approach	Part of the Care About the Bay ... Don't Throw It Away Program. Written for use in units one and two of VCE Chemistry, 'Materials and Chemistry in Everyday Life'. An excellent resource for all students of senior chemistry.
Requirements	Interested schools should contact STAV Publishing for an order form. The cost of the <i>Rain and Drain Chemistry</i> booklet is \$7.50, plus postage and handling.
Support material	<i>Rain and Drain Chemistry</i> booklet, which outlines a range of activities designed to help students understand the chemistry of stormwater and the atmosphere. These activities include practical work, analysing information from graphs and other data, concept mapping, role plays and problem solving.
Contact details	Contact STAV Publishing Pty Ltd on (03) 9428 2633.

## **6.6** Enforcement

### **6.6.1 Roles and principles of enforcement**

Enforcement should be seen as a complement to management and education strategies. Councils have a variety of enforcement responsibilities and powers which are supported by those of other authorities, including EPA and CMAs/Melbourne Water. Enforcement may involve a warning or service of a notice requiring the recipient to carry out specified actions or imposing financial penalties.

Enforcement should be fair, predictable and consistent and should be blind to whether the party involved is an individual, company or government agency. The primary purpose of enforcement should be to prevent future problems by making polluters accountable. This acts to improve the polluter's practices and deter others from carrying out polluting activities.

### **6.6.2 Who should enforce?**

For some types of stormwater complaints and pollution incidents, enforcement provision is available to more than one agency. The powers of council and EPA, for example, overlap. In these cases the agencies need to develop an understanding about who does what and how issues will be resolved.

In principle, the agency that permits a potentially polluting activity should enforce conditions on that activity. In other words, specific approvals (e.g. permit or licence) to use or develop land should be enforced by the permitting agency, including resolution of issues resulting from omissions at the approval stage. In the absence of specific approvals, any general right (e.g. planning scheme) to use or develop land should be enforced by the responsible authority to protect environment or amenity. The significance of an incident may also give some guidance on when local or State enforcement powers should be used. In some instances joint action between council and other agencies may be appropriate.

In general, council should take enforcement action when:

- a use is breaching the general amenity protection clause in relevant land-use zones;
- a breach of the planning scheme or a planning permit exists;
- a local law is being breached;
- a litter offence is noted; or
- a nuisance is being caused.

EPA should take enforcement action when:

- pollution or a state of environmental hazard is occurring or is likely to occur;



- a premises is causing a recurring breach of State environment protection policy;
- a scheduled premises is the source of problems;
- a litter offence is noted; or
- attempts to use local powers have proven ineffective in resolving a problem.

### **6.6.3 Enforcement powers of local government**

---

#### **Planning controls**

The State Planning Policy Framework of Victoria requires all Local Government Planning Schemes to accord with State Environment Protection Policies (SEPP). SEPP (*Waters of Victoria*) states that 'where run-off from the land surface is likely to cause non-compliance with SEPP objectives, control measures such as the elimination or treatment of sources of contaminated run-off and/or changes to land-use or land management practices shall be applied where practicable'. These Best Practice Guidelines provide a practical means for minimising the impacts of urban stormwater run-off. Chapter 4 provides more information on the use of planning controls in stormwater management.

#### **Planning enforcement**

An authorised officer of a council may serve a Section 130 (*Planning and Environment Act 1987*) planning infringement notice on any person that the officer considers has committed an offence, including failure to comply with a planning scheme, planning permit or an agreement under the Act. These offences carry a fine of \$200 and can stop the development or use of land, require action to prevent or minimise adverse impacts of development, or any other action to expiate the offence.

Council or any person can seek an S119 enforcement order, or the more immediate interim enforcement order, from the Victorian Civil and Administrative Tribunal (VCAT) to require the land-use to comply with the requirements of the planning scheme or a permit or agreement.

Council may authorise staff to conduct enforcement processes under the Planning and Environment Act. Authorised officers have powers of entry and can issue planning infringement notices. Many councils employ planning enforcement officers for this purpose. It is usually council or a delegated senior manager that would make the decision to apply for an enforcement order from the VCAT.

#### **Local laws**

Under Section 111(1) of the *Local Government Act 1989* a council may make local laws for or with respect to any act, matter or thing in respect of which the council has function or power under this or any other Act. The intention of this provision is to link a council's local law making power to its functions and powers conferred elsewhere. A local law cannot be inconsistent with an Act or Regulation and to the extent that it is,

it will not comply. This does not necessarily mean, however, that it cannot duplicate an existing law.

Section 8 of the *Local Government Act 1989* provides that a council has the functions listed in Schedule 1 of that Act. Schedule 1 provides that councils have functions relating to the peace, order and good government of the municipal district including environmental control, protection and conservation.

Councils have the power to introduce local laws to protect stormwater quality which is fundamentally related to councils' environmental protection function.

Local laws can protect many aspects of the environment. Some existing local laws which relate to stormwater protection are attached by way of example.

The powers to enforce local laws are usually delegated to local laws officers, but councils can appoint any person (other than a councillor) to enforce the provisions of a local law.

### **Local laws for stormwater protection: example**

The following local laws are currently in use by one or more Victorian councils.

#### **Stormwater**

- An owner or occupier of any land must not cause or permit any substance other than stormwater to be discharged from the land into the stormwater system, unless otherwise authorised by council or a statutory authority.

#### **No waste beyond the boundaries**

- An owner or occupier of land must not cause or permit the discharge of any solid, liquid or gaseous waste beyond the boundaries of the land, unless otherwise authorised by council or a statutory authority.

#### **Construction sites: protection of roads and stormwater**

- A person must not cause or permit the deposition of solid or liquid waste, sand, silt, clay, stones or sediment on roads by vehicles leaving a premises.
- In the event that any waste from a premises is deposited on a roadway, a person must not cause or permit that waste to enter the stormwater system.
- A person must not cause or permit solid or liquid waste, sand, silt, clay, stones or sediment to be discharged from a premises to the stormwater system, unless otherwise authorised by council or a statutory authority.

#### **Construction sites: materials storage**

- A person must not cause or permit stored building or other materials to spill, leak or otherwise leave the premises in an uncontrolled manner, or to be left on a road unless otherwise authorised by council or a statutory authority.

### **The Litter Act**

The *Litter Act 1987* provides protection of the environment from the depositing of a broad range of materials including most types of solid or liquid domestic or commercial waste.

Authorised officers under the Litter Act can issue abatement notices and penalty infringement notices for Litter Act offences. Abatement notices can be served where activities have caused or are likely to cause the deposit or escape of litter. Infringement notices can carry fines of between \$20 and \$600. Council can also initiate prosecution under the Act which can lead to penalties of up to \$2000 (deposit of litter) or \$4000 and a month's imprisonment (aggravated littering). The Litter Act does not apply to the deposit of any litter that constitutes an offence under the Environment Protection Act.

Council can authorise officers under the Litter Act. Generally local laws officers and environmental health officers are authorised.

### **Nuisances and the Health Act**

Part III of the Health Act 1958 gives exclusive responsibilities and powers to councils to control nuisances which are dangerous to health or offensive. 'Offensive' is defined as noxious, annoying or injurious to personal comfort. It is an offence to cause a nuisance.

Councils must remedy nuisances as far as is reasonably possible by serving the offender with a notice to abate the nuisance. An authorised officer has powers of entry to a premises to enforce the provisions of the Health Act.

The nuisance provisions provide council with an enforcement tool which may cover stormwater impacts which do not breach planning controls, the Environment Protection Act or the Litter Act.

Council environmental health officers are usually delegated powers to enforce the nuisance provisions of the Health Act.

### **Writing enforceable notices and planning permits**

Some general principles for writing notices are:

- start each requirement with an action word;
- place a single, specific, measurable obligation in each requirement;
- provide time-frames for any required works; and
- require the recipient to demonstrate compliance.

Following these principles should ensure that there is no subsequent dispute about whether or not a breach has occurred, and should minimise council's follow-up work.

# Chapter 7

## Structural Treatment Measures

### 7.1 Introduction

Stormwater structural treatment measures can be grouped into three categories: primary, secondary and tertiary.

#### **Primary treatment**

Physical screening or rapid sedimentation techniques. *Typical retained contaminants:* gross pollutants and coarse sediments.

#### **Secondary treatment**

Finer particle sedimentation and filtration techniques. *Typical retained contaminants:* fine particles and attached pollutants.

#### **Tertiary treatment**

Enhanced sedimentation and filtration, biological uptake, adsorption onto sediments. *Typical retained contaminants:* nutrients and heavy metals.

Many of the treatment measures described in this chapter are recent developments and are still undergoing field testing. There is a need for further long term performance monitoring of these techniques—some may demonstrate incidental environmental impacts not yet recognised. This, and the complexity of the pollutant retention processes involved, make estimating pollutant retention an imprecise science. As a result, refinements to treatment design parameters can be expected over time.

### 7.2 Selecting a stormwater treatment measure

The selection and implementation of structural treatment measures involves six steps. These are:

- 1 **Determine treatment objectives:** establish the pollutants of concern in the catchment (e.g. litter, sediments, nutrients) and the level of pollutant retention required.

- 2 **Develop treatment train:** assess the treatment processes required and appropriate measures and ordering, including any pre-treatment requirements (e.g. screening of coarse sediments or flow control).
- 3 **Site identification:** identify potential sites and site constraints (e.g. slopes and soil types).
- 4 **Short-list potential treatments:** identify all applicable treatments.
- 5 **Compare potential treatments:** compare all potential treatments for removal efficiency, maintenance requirements, social impacts and costs.
- 6 **Detailed design:** complete detailed design of the optimal treatment.

These Guidelines review the first five steps of this process. The detailed design process requires further, more site specific information and is outside the scope of these Guidelines. An example of determining an installation plan for litter traps within a municipal authority is also presented in Appendix A. It demonstrates a methodology for selecting and ranking treatment options using litter as the target pollutant.

### 7.2.1 Treatment objectives

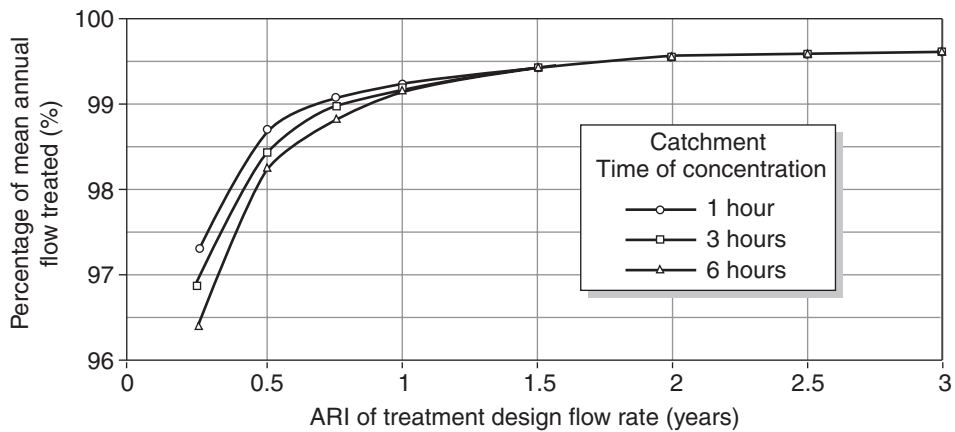
---

The stormwater pollutant profile of any catchment area is determined largely by the area's land-use and stormwater management. For example, human derived litter can be a problem in commercial areas, whereas sediment run-off is often more prevalent in developing urban areas.

To isolate the pollutants of concern in any catchment, the designer needs to closely examine receiving water degradation in light of the area's land-use and current management practices. The performance objectives set out in Chapter 2 are a guide to the typical pollutant load reductions required to contribute to State Environment Protection Policy (SEPP) compliance.

In order to protect receiving waters, treatments may be required to reduce the impact of one or more of the following pollutant categories:

- **gross pollutants:** trash, litter and vegetation larger than five millimetres;
- **coarse sediment:** contaminant particles between 5 and 0.5 millimetres;
- **medium sediment:** contaminant particles between 0.5 and 0.062 millimetres;
- **fine sediments:** contaminant particles smaller than 0.062 millimetres;
- **attached pollutants:** those that are attached to fine sediments—specifically, nutrients, heavy metals, toxicants and hydrocarbons; and/or
- **dissolved pollutants:** typically, nutrients, metals and salts.



**Figure 7.1 Treatment design flows plotted against the percentage of mean annual flow treated for the Melbourne region (after Wong 1999).**

The treatment measures considered in these Guidelines have been assessed according to their trapping efficiency for each pollutant category.

The overall treatment effectiveness of a measure is a function of its pollutant removal rate and the volume of run-off treated. A high flow by-pass is generally designed into treatment measures for protection from large flood flows that could damage the device or scour and transport previously collected pollutants downstream. The maximum flow rate at which a treatment measure is designed to operate effectively is termed the *design flow*.

Selecting the design flow is a trade-off between the cost and space requirements of the device (a higher design flow will generally require a larger facility with additional costs) and the volume of water that could potentially by-pass the measure and avoid treatment. Figure 7.2 plots the volume of mean annual run-off that would be treated at or below the design flow rate for a range of design standards for several hypothetical catchments with different times of concentration using Melbourne rainfall data. For regions outside Melbourne there is a procedure to determine the appropriate relationship (Wong et al. 1999).

The plot shows that the curves are relatively independent of the time of concentration of the catchment and also that the incremental benefit of increasing the treated volume of run-off diminishes beyond a design flow rate of the 2 year ARI. Further, the plot suggests that generally the optimum operating range falls within a design flow rate of between 0.25 and 1.0 year ARI discharges.

### 7.2.2 Develop treatment train

Many pollutant treatments, particularly those targeting fine pollutants, require a number of measures used in sequence to be effective. Figure 2.3 illustrates a relationship between pollutant type and treatment processes. There is a clear relationship between pollutant

Particle sizes	Treatment measures	Hydraulic loading
		$\frac{Q_{design}}{A_{facility}}$ (m/year)
	<b>Primary</b> <b>Secondary</b> <b>Tertiary</b>	
Gross pollutants > 5000 $\mu\text{m}$	Floating traps Entrance traps In-line traps	1,000,000
Coarse sediment 500–5000 $\mu\text{m}$	Self-cleaning screens Sediment traps	100,000
Medium sediment 62–500 $\mu\text{m}$		10,000
Fine sediment/ attached pollutants 0.45–62 $\mu\text{m}$	Pre-entrance traps In-transit traps	2,500
Dissolved pollutants < 0.45 $\mu\text{m}$	Wetland systems	50
		10

**Figure 7.2 Desirable design ranges for treatment measures and pollutant sizes (adapted from Wong 1999).**

size (gross to dissolved) and the appropriate process that can be employed to retain the pollutant. The treatment types in Figure 7.2 show the size range of pollutants that each treats effectively. By knowing the target pollutants appropriate treatment measures can be selected.

The figure also illustrates the approximate hydraulic loading rate for effective operation of the various treatments. The hydraulic loading rate is a function of the treatment process (either screening, sedimentation, enhanced sedimentation, filtration or biological uptake) and can be used to approximate the area required to install a facility given the design flow. This is useful to assess the space requirements for the various treatments.

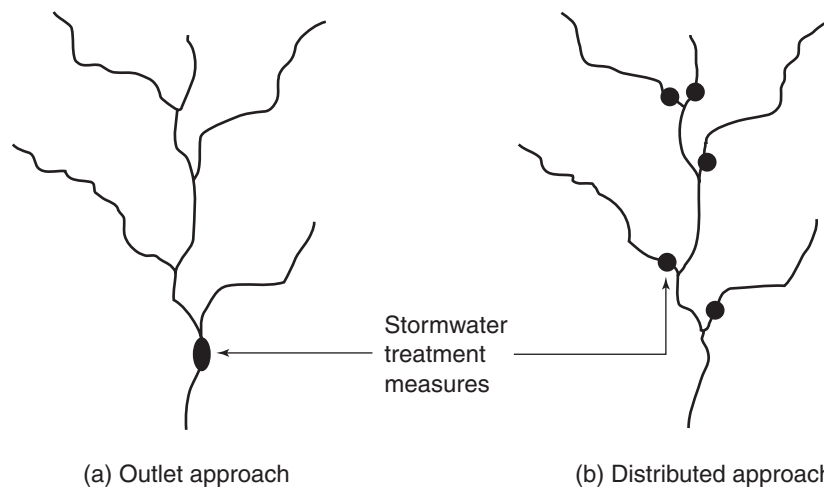
The treatment train approach is particularly important when a measure requires pre-treatments to remove pollutants that may affect the performance of the treatment measure. For example, wetland systems are often employed to protect receiving environments from the impact of excessive nutrients and heavy metals. However, wetlands will perform poorly if gross pollutants and coarse sediments are not removed prior to the wetland treatment. It is therefore important to select and order treatment measures appropriately to ensure that wetland systems are protected from gross pollutants and coarse sediments.

By taking this ‘treatment train approach’, as described in Chapter 2, the most effective sequence of the treatments can be determined.

### 7.2.3 Site identification

#### Locating a treatment

When determining the location for stormwater treatment measures, many factors must be considered. One fundamental question is whether to adopt an ‘outlet’ or a ‘distributed’ approach.



**Figure 7.3** Outlet and distributed approaches to stormwater treatment location.

The traditional outlet approach involves constructing a single large treatment at the catchment's outlet. Although this 'single site' approach offers obvious maintenance advantages, it has the disadvantage of needing to treat very large volumes of water at a location sometimes far from the pollutant's source.

An alternative is the distributed approach. Here, a number of smaller and potentially different treatments are installed throughout a catchment.

A distributed approach to stormwater pollution treatment has many advantages over the outlet approach. These include:

- **improved protection:** water quality protection may be distributed along a greater length of the waterway;
- **localised treatment:** specific targeting of treatments may be directed at highly polluted sites;
- **distributed risk:** the distributed approach has a lower risk of overall system failure, as the failure of any single treatment will not usually significantly impact on the total treatment system performance;
- **improved removal efficiencies:** distributed treatments are typically located in areas of lower flow. Lower flow velocities and volumes and high pollutant concentrations in stormwater at these sites lead to higher operating efficiencies; and
- **staged implementation:** individual sites may be brought into operation in stages.

Typically, a distributed treatment scheme will incorporate a range of structural treatment types. To ensure optimal pollutant removal efficiency, a treatment train approach should be considered during each step of the design process—particularly where pre-treatment may be an issue.



### Site constraints

The characteristics of a particular site can limit the choice of treatment measures suited to the area. These constraints fall broadly into two categories-physical and social.

Physical site constraints can make construction difficult or impossible, and maintenance expensive. Factors to consider include:

- **topography:** e.g. steep slopes;
- **soils and geology:** e.g. erosivity, porosity, depth to bedrock or instability;
- **groundwater:** e.g. geochemistry and water table depth; and
- **space:** limited open space, proximity to underground services, e.g. gas, power.

Social constraints include issues of health and safety, aesthetics and impacts on recreation facilities. Factors to consider include:

- **odour problems;**
- **visual impacts;**
- **noise;**
- **physical injury:** resulting from unauthorised access to structures;
- **contamination:** infection, poisoning or injury caused by trapped pollutants or algal blooms; and
- **vermin:** e.g. mosquitoes, rats.

Many social issues can be addressed simply during the treatment design stage. This may involve development of occupational health and safety procedures for operations and maintenance staff, installation of warning signs, fencing around dangerous areas and so on.

#### 7.2.4 Short-list potential treatments

---

A short list of potential treatment techniques that meet the requirements for the target pollutants and site constraints should be developed.

Various primary, secondary and tertiary treatment techniques are listed in Tables 7.1, 7.2 and 7.3 respectively, along with their pollutant retention efficiencies for a range of contaminants.

Specific pollutant retentions can be compared to the performance objectives set in Table 2.1. The pollutant retention efficiencies are based on the desirable hydraulic loading rate and are listed for all six pollutant categories: gross pollutants, coarse sediments, medium sediments, fine sediments, attached pollutants and dissolved pollutants.

Pollutant retention efficiencies are graded as follows:

- **very high (VH):** 80 to 100 per cent of total pollutant load retained;
- **high (H):** 60 to 80 per cent of total pollutant load retained;
- **moderate (M):** 40 to 60 per cent of total pollutant load retained;
- **low (L):** 10 to 40 per cent of total pollutant load retained; and
- **negligible (N):** less than 10 per cent of total pollutant load retained.

These efficiency classifications allow the designer to quickly reject those techniques which have little impact on the target contaminants. For example, primary and secondary treatments would not be short-listed when specifically targeting dissolved nutrient or metal contamination—only tertiary treatments will have an impact in this case.

### 7.2.5 Compare potential treatments

---

Having established a short list, the treatment measures should be reviewed in detail to determine the best options. Factors to consider include maintainability and operability, pollutant retention, head requirements, cost and secondary benefits. These considerations are further described below.

Sections 7.7, 7.8 and 7.9 describe a wide range of treatment types. Each description presents a review of the treatment measure's operation, advantages, limitations, performance, costs and maintenance requirements.

#### Maintenance and operation

A poorly maintained treatment measure may not only perform badly; it may become a flood hazard or a source of pollution itself. Treatment measure operation and maintenance requirements vary widely. When assessing the treatment measure's maintainability and operability, the following issues should be considered:

- **ease of maintenance and operation:** the selected treatment should be easy and safe to maintain and operate;
- **extent of maintenance:** ensure the maintenance requirements are within the operator's capability;
- **access to the treatment site:** consider the ease of site access, when reviewing the treatment's maintenance requirements;
- **frequency of maintenance:** ensure that resources are available to carry out maintenance at the required frequency;

- **debris and pollutant clearing:** during clearing, the treatment should not require direct human contact with debris and trapped pollutants (automated clearing facilities are preferred); and
- **disposal:** consider the disposal of any waste from the treatment process.

### **Pollutant retention**

A closer look at the treatment measure's pollutant retention is required at this stage. Depending on issues of maintainability, operability, cost and head requirements, the overall pollutant retention efficiency for each specific target pollutant should preferably be as high as possible.

### **Head requirements**

Some treatments require large amounts of hydraulic head for operation. These are obviously not suitable for use in low lying areas with mild drain slopes.

Tables 7.1, 7.2 and 7.3 list the head requirements for primary, secondary and tertiary treatment types respectively. These have been classified as follows:

- **high:** more than 1 metre;
- **moderate:** between 0.5 and 1 metres; and
- **low:** less than 0.5 metres.

### **Cost**

Relative capital and maintenance costs for treatments are presented in Tables 7.1, 7.2 and 7.3. These are indicative rankings only; costs will vary according to catchment characteristics and rainfall.

Capital costs are based on the treatment's total installed cost per hectare of catchment. Broad approximations to give the reader a starting point are categorised as:

- **high (H):** greater than \$1500 per hectare of catchment;
- **moderate (M):** between \$500 and \$1500 per hectare of catchment; and
- **low (L):** less than \$500 per hectare of catchment.

Maintenance costs are based on the cost per hectare per annum of the particular treatment type. Once again, broad estimates are categorised as:

- **high (H):** greater than \$250 per hectare of catchment per annum;
- **moderate (M):** between \$100 and \$250 per hectare of catchment per annum; and
- **low (L):** less than \$100 per hectare of catchment per annum.



**Figure 7.4** Some treatment measures provide more benefits than just pollutant removal.

Maintenance costs in this section include inspections, and routine maintenance and cleaning operations, but do not include any disposal costs associated with removed pollutants.

Detailed cost information can be obtained from the treatment suppliers.

### **Secondary benefits**

Certain treatment measures provide incidental benefits beyond the primary goal of removing the target pollutants.

Some treatment measures demonstrate the potential to remove pollutants other than the primary targets, e.g. a litter trap that also removes sediment. Other treatment types provide added benefits such as aiding flood control, ecological enhancement or provision of an educational resource. All such benefits need to be considered when selecting a treatment measure.

## **7.3**

### **Primary stormwater treatment**

---

There is a wide choice of primary treatment measures available, with an increasingly diverse range of treatment types being used throughout Australia. Primary treatment measures vary in size, cost and trapping performance by orders of magnitude.

New designs are evolving rapidly. There is generally a shortage of data relating to the trapping performance of the newer methods, making treatment comparisons difficult.

These Guidelines describe some 17 types of primary treatments identified at the time of publication. These have either been used extensively in Australia, or are becoming more frequently used and show promise for efficient pollutant removal.

The primary treatment measures described fall into one of five operating types:

- 1 **drainage entrance treatments:** grate entrance systems, side entry pit traps and baffled pits;
- 2 **in-line methods:** litter collection baskets, boom diversion systems, release nets, trash racks, gross pollutant traps, return flow litter baskets, and hydraulically operated trash racks;
- 3 **self-cleaning screens:** circular screens, downwardly inclined screens;
- 4 **floating traps:** flexible floating booms, floating debris traps; and
- 5 **sediment traps:** sediment settling basins and ponds, circular settling tanks, hydrodynamic separators.

### **Drainage entrance treatments**

Drainage entrance treatments involve either preventing the pollutants' entry into the stormwater drainage system, or capturing the pollutants at drainage entrance points. This can be achieved by either restricting the stormwater entrance size, capturing the pollutants as stormwater falls into the drainage system, or retaining the pollutants in the entrance pit.

Entrance treatments are generally located close to the pollutant source allowing the most polluted areas to be targeted. Use of entrance treatments can also help to reduce downstream pipe blockages.

### **In-line devices**

In-line methods use direct screening to retain gross solids by passing flow through a grid or mesh barrier assembly. As pollutants build up at the barrier, smaller material may also be retained due to the reduced effective pore size. There are various trapping methods using either baskets, prongs, racks or perforated bags.

These systems are generally simple to install and can retain large quantities of material. One limitation is the possibility of blockage. If the pores in the barrier are blocked, water levels may rise and spill collected pollutants downstream.

In-line non-screening devices direct stormwater into off-line chambers that collect pollutants by altering the hydraulics in the chamber. The systems divert flow and pollutants by means of a boom that is capable of rising during times of high discharge.

### **Self-cleaning screens**

The tendency of in-line screens to block is their main limitation. To improve in-line screen performance, there have been numerous attempts to design a self-cleaning trash screen.

Two self-cleaning designs have been used successfully: circular screens and downwardly inclined screens.

Developed in Victoria, circular screens induce a vortex that keeps pollutants continually in motion and this keeps the screen free of debris.

The second process, downwardly inclined screens, has been developed independently in New South Wales and South Africa. It involves angling a trash rack downstream. Gravity and the force of the water push the pollutants down the screen and onto a holding shelf.

### **Floating traps**

Floating traps are generally intended to remove highly buoyant and visible pollutants such as plastic bottles. These are typically installed in the lower reaches of waterways where velocities are lowest.

The earliest boom designs were based on those used for oil slick retention. Floating traps generally consist of a partly submerged floating barrier fitted across the waterway, which either retains the pollutants or deflects them into a retention chamber. Floating traps have been employed for some time in Australia's major cities. More recent developments incorporate pollutant retention chambers and advanced trap clearing methods.

### **Sediment traps**

There are a number of sediment traps available, ranging from simple 'swimming pool' designs to complex structures using vortices and secondary flows for sediment separation. Each trapping system aims to create favourable flow conditions for sedimentation. The swimming pool type sediment traps can be either concrete basins or more natural ponds constructed with site soils. They retain sediments by simply enlarging the channel so that water velocities are reduced. More complex sediment traps generate vortex flows, which enhance sedimentation through secondary flows. Sediment traps are ideal for pre-treatment of larger sediment particles prior to a constructed wetland system.

#### **7.3.1 Summary of primary treatments**

---

Table 7.1 presents a summary of the primary treatments reviewed in the Guidelines (Section 7.7). It presents relative estimates of the trapping performances, installation and maintenance costs per hectare, head requirements and approximate catchment area per unit treatment.

## **7.4**

### **Secondary stormwater treatment**

---

Secondary treatments are used to retain or remove coarse, medium and fine sediments from stormwater and can be divided into two broad categories:



**Figure 7.5 Swales (in this case, rock lined) promote infiltration, retard flows, improve water quality and can add to the local amenity.**

- **pre-entrance treatments:** filter strips, grass swales, triple interceptor pits, porous pavements and infiltration trenches; and
- **in-transit treatments:** infiltration basins, extended detention basins and sand filters.

### **Pre-entrance treatments**

Pre-entrance treatments either use infiltration techniques to separate out entrained sediments from stormwater before it enters the drainage network or use enhanced sedimentation to contain contaminants. Infiltration can be achieved in one of two ways—either by flowing the stormwater over vegetated land to encourage infiltration or by using purpose built infiltration structures.

Filter strips and grass swales are typical examples of flowing water over vegetation. Purpose built infiltration structures include infiltration trenches and porous pavements.

These methods have the advantage of separating out pollutants close to the source, thereby avoiding the difficulties of entrained flow pollutant removal.

Device	Catchment area (ha)	Trapping efficiency					Cleaning frequencies	Head requirements	Installation costs	Maintenance costs
		gross pollutants	coarse sediment	medium sediment	fine sediment	attached pollutants				
Grate and entrance screens	0.1-1	L	N	N	N	N	weekly	L	L/M	
Side entry pit traps	0.1-1	M/H	L	N	N	N	monthly	L/M	M/H	
Baffled pits	0.1-2	L	M	L/M	L	N	monthly	L/M	L/M	
Litter collection baskets	2-150	M/H	L/M	N	N	N	weekly/monthly	M/H	M/H	
Boom diversion systems	10-40	M	L/M	N/L	N	N	monthly	M	M/H	
Release nets	1-50	M/H	N/L	N	N	N	weekly/monthly	L	L/M	
Trash racks	20-500	L	N/L	N/L	N	N	monthly	M	L/M	
Gross pollutant traps	5-5000	L/M	M/H	M	L	N	monthly/quarterly	H	M/H	
Return flow litter baskets	20-100	M/H	M	L	N	N	monthly	M/H	L/M	
Hydraulically operated trash racks	>10	H/VH	L/M	N	N	N	weekly	L/M	M/H	
Circular screens	5-150	VH	H	M	L/M	L	quarterly	H	M	
Downwardly inclined screens	5-500	H/VH	N	N	N	N	monthly/quarterly	M/H	L/M	
Flexible floating boom	>100	N/L	N	N	N	N	weekly/monthly	L	M	
Floating debris traps	>100	L	N	N	N	N	weekly/monthly	L	M	
Sediment settling basins	10-500	N	M/H	M	L	N/L	half-yearly	L/M	L/M	
Circular settling tanks	1-20	L/M	H	M/H	M	L/M	monthly	H	M	
Hydrodynamic separation	5-100	L/M	M/H	M	M	L/M	monthly	H	L/M	

N = negligible, L = low, M = moderate, H = High, VH = very high

**Table 7.1 Summary of primary treatments.**



### In-transit treatments

In-transit secondary treatments target entrained pollutants flowing through the storm-water system. These either use reduced water velocities to encourage sedimentation or direct filtration through a porous medium.

Reduced velocities are typically achieved using storage ponds, such as infiltration and detention basins. The direct filtration methods use sand filters to screen stormwater as it flows through the sand grains, leaving the pollutant in the sand. These can remove large quantities of pollutants, but require regular maintenance.

#### 7.4.1 Summary of secondary treatments

Table 7.2 presents a summary of the secondary treatments reviewed in the Guidelines (Section 7.8). It shows relative estimates of the trapping performances, installation and maintenance costs per hectare, head requirements and approximate catchment area per unit treatment.

## 7.5 Tertiary treatment types

Constructed wetland systems are generally the only treatment technique used for removal or retention of nutrients and fine sediments. This section describes and summarises the pollutant retention performance of constructed wetlands and provides some basic design information (Section 7.9). Sufficient design information is presented to enable preliminary sizing of a wetland system to meet the performance objectives set in Chapter 2. The detailed design is an involved process requiring the input of several disciplines such as hydrology, aquatic biology and landscape planning.

Criteria	Value/ranking
Catchment area (hectares)	>10
Trapping efficiency: gross pollutants	L/M
Trapping efficiency: coarse sediments	H
Trapping efficiency: medium sediments	M/H
Trapping efficiency: fine sediments	L/M
Trapping efficiency: attached pollutants	M/H
Trapping efficiency: dissolved pollutants	L/M
Head requirements	L/M
Installation costs	H
Maintenance costs	M

N = negligible, L = low, M = moderate, H = high, VH = very high

**Table 7.3 Constructed wetlands treatment performance.**

Sand filters that include a media layer with an adsorption capacity (e.g. peat or humus) could also be classified as tertiary treatment measures. This is a relatively recent innovation in sand filter design—until recently, sand filters have been classified as secondary treatment measures. A more detailed description of sand filters is included in Section 7.4.

Device	Catchment area (ha)	Trapping efficiency						Head requirements	Installation costs	Maintenance costs
		gross pollutants	coarse sediment	medium sediment	fine sediment	attached pollutants	dissolved pollutants			
Filter strips	0.1-1	L/M	H	M/H	L/M	L/M	L	L	L	
Grass swales	0.1-5	L	M/H	M	L/M	L/M	L	L	L	
Triple interceptor pits	0.1-1	L/M	M	L/M	L	L	N	M	H	
Porous pavements	0.1-1	L	H	M/H	M	M	L	M	L/M	
Infiltration trenches	0.1-5	L	M/H	M	L/M	L/M	L	L	M/H	
Infiltration basins	10-100	N	M/H	M	M	M	L	L	H	
Extended detention basins	10-500	L	M/H	M	L/M	L/M	L	L/M	M/H	
Sand filters	1-50	L	M/H	M/H	M	M	L	M/H	M/H	

N = negligible, L = low, M = moderate, H = High, VH = very high

**Table 7.2 Summary of secondary treatment performances.**

## 7.6 Flow management

---

Urbanisation has significant impacts on catchment hydrology, which in turn affects the physical and biological characteristics of waterways. Recent initiatives in integrated stormwater management have recognised the importance of water quality. However, the importance of managing the impact of changes in flows on receiving waterways must also be taken into account. The two main characteristics of urban development that alter flow regimes in waterways are:

- removed vegetation and increased impervious area in the catchment; and
- increased hydraulic efficiency within drainage lines and receiving waterways.

These characteristics increase both the magnitude and frequency of peak discharges, with the greatest impact resulting from increased hydraulic efficiency. There are opportunities to integrate both hydraulic capacity and waterway health objectives within a stormwater system. This is particularly so as limiting changes in peak discharge is a critical component of protecting aquatic ecosystems as well as reducing the incidence of flooding.

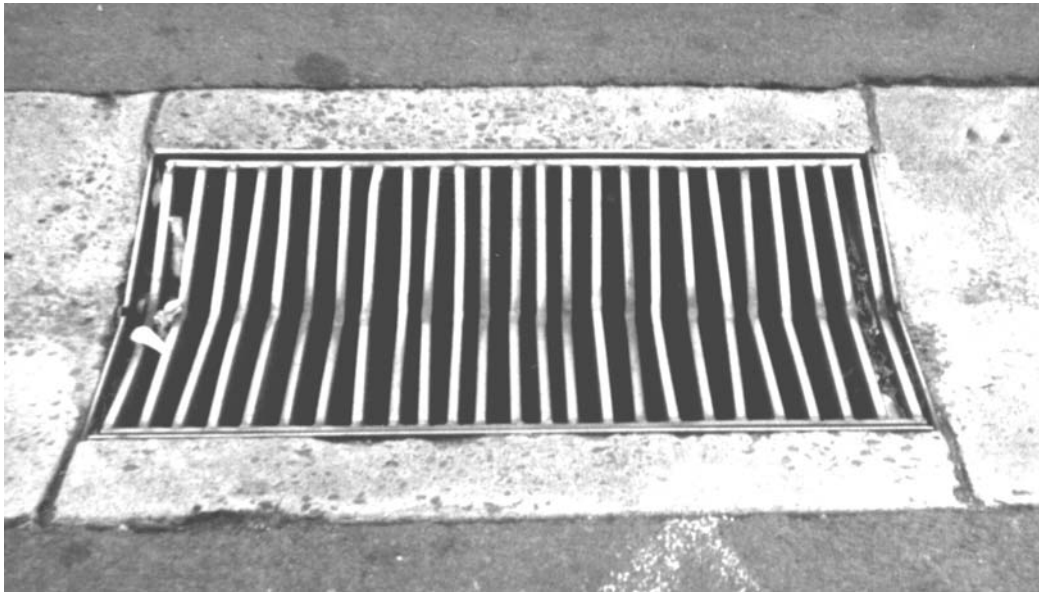
Section 7.10 outlines the objectives of effective flow management and presents a range of flow management techniques.

**7.7**

**Primary treatment: index**

---

<b>Primary treatment type</b>	<b>Page no.</b>
Drainage entrance types	
Type 1: Grate and entrance screens	134
Type 2: Side entry pit traps (SEPTs)	135
Type 3: Baffled pits	138
<b>In-line types</b>	
Type 4: Litter collection baskets	140
Type 5: Boom diversion systems	142
Type 6: Release nets	144
Type 7: Trash racks	146
Type 8: Gross pollutant traps	148
Type 9: Return flow litter baskets	151
Type 10: Hydraulically operated trash racks	152
<b>Self cleaning screen types</b>	
Type 11: Circular screens	155
Type 12: Downwardly inclined screens	157
<b>Floating trap types</b>	
Type 13: Flexible floating booms	159
Type 14: Floating debris traps	162
<b>Sediment trap types</b>	
Type 15: Sediment settling basins and ponds	164
Type 16: Circular settling tanks	166
Type 17: Hydrodynamic separators	168



**Figure 7.6 Grated entrance screen.**

### **Primary treatment Type 1: Grate and entrance screens**

#### *Description*

Grate and entrance screens consist of sturdy metal screens that cover the inlet to the drainage network. Water passes between the screen bars, while gross pollutants are prevented from entering. Particularly suited to trapping large litter items, grate and entrance screens are typically used to prevent drain blockages.

#### *Advantages*

- inexpensive and easy to install;
- prevents drain blockages; and
- suitable for targeting specific problem areas.

#### *Limitations*

- only separates out large rubbish items;
- relies on effective street cleaning for pollutant removal;
- local flooding can occur if blocked; and
- smaller items of rubbish may be pushed through the grating by traffic.

<b>Estimated treatment performance summary</b>					
gross pollutants	L	coarse sediment	N	medium sediments	N
fine sediments		attached pollutants	N	dissolved	N
installation costs	L	maintenance costs	L/M	head requirements	L
N = negligible, L = low, M = moderate, H = high, VH = very high					

### *Trapping performance*

The key function of entrance screens is to prevent pipe blockages by excluding gross pollutants from the drain network. Their performance efficiency depends heavily on effective street cleaning practices—infrequent street cleaning can lead to dispersion of trapped pollutants by either wind or traffic.

### *Cost considerations*

Installation costs of entrance grate and screens are low. If cleaning can be incorporated into regular street cleaning, no additional maintenance cost need apply.

### *Design considerations*

Entrance grates should be located in areas that are prone to pipe blockages or are known to contribute large amounts of gross pollutants. These include shopping centres and other busy commercial areas.

### *Maintenance*

Inspections for blocked screens may be necessary if flooding is a potential problem.

*See also:* Side entry pit traps, Street cleaning.

## **Primary treatment Type 2: Side entry pit traps (SEPT)**

### *Description*

Side entry pit traps (SEPTs) are baskets that are placed in the entrance to drains from road gutters. The baskets are fitted below the invert of the gutter, inside the drainage pit. Stormwater passes through the baskets to the drain, with material larger than the basket mesh size (5–20 millimetres) retained.

Material remains in the basket until removed during maintenance, either manually or by vacuum extraction. The traps are generally cleaned every four to six weeks in high litter load areas.

### *Advantages*

- prevents drain blockages;
- suitable for targeting specific problem areas;
- can be retrofitted into existing drainage systems;
- can be used as a pre-treatment for other measures;
- can retain fine material, as the basket pores block; and
- minimal visual impact, as SEPTs are installed underground.

### *Limitations*

- distributed traps may be maintenance intensive;



**Figure 7.7 Section view of a SEPT.**

- requires regular maintenance, due to the trap's limited holding capacity;
- previously caught material may be resuspended if overtopping occurs; and
- only suitable for road entrance installations.

<b>Estimated treatment performance summary</b>					
gross pollutants	M/H	coarse sediment	L	medium sediments	N
fine sediments	N	attached pollutants	N	dissolved	N
installation costs	L/M	maintenance costs	M/H	head requirements	L
N = Negligible, L= Low, M = Moderate, H = High, VH = Very high					

### *Trapping performance*

Best suited to trapping coarse material, SEPTs can also retain finer contaminants as the basket pores block. SEPTs can trap significant quantities of gross pollutants and have the advantage of being suitable for targeting specific areas such as shopping centres, schools and car parks.

SEPTs can potentially capture up to 85 per cent of litter load and up to 75 per cent of the total gross pollutant load, if installed on all public road entrances to the stormwater system (see Allison et al. 1997). SEPTs' high maintenance requirements usually set a practical upper limit to the extent of SEPT application within a catchment. It is therefore

imperative to choose those drain entrances that contribute the greatest gross pollutant loads to the drainage system, when locating SEPTs.

The monitoring of Allison et al. (1997) revealed that by careful selection of SEPT locations, it is possible to capture approximately 65 per cent of the litter and 50 per cent of total gross pollutant loads (litter and organic material), by locating SEPTs at only 40–50 per cent of the drainage entrances.

The overall SEPT trapping efficiency within an area is influenced by individual trap efficiencies, along with the amount of pollutants that successfully by-passes the SEPT network. Potential by-pass paths include direct roof run-off from buildings and drainage through grates located in private car parks or grassed areas.

### *Cost considerations*

SEPTs are generally inexpensive to install, but require considerable effort and cost to maintain. Individual traps costs between \$60 and \$450, depending on construction materials and design. Cleaning costs are typically between \$5 to \$25 per pit per clean. A significant factor in determining final SEPT cost and trapping performance is the overall SEPT application density used in the catchment.

### *Design considerations*

A range of SEPTs are manufactured to suit most applications. The pit size, depth and lid type are important factors when assessing a SEPT's suitability for a particular location. SEPTs are ideal for targeting specific pollution areas such as shopping centres and strips, schools and train stations. The main design issues are the selection of appropriate trap sites and deciding what proportion of pit entrances to cover.

In addition, the pits need to be of adequate size to allow a clear space at the rear of the basket to provide an overflow route should the basket become blocked.

### *Maintenance*

SEPTs are generally cleaned with a suction truck. The lid of the pit is lifted and the contents of the baskets vacuumed out. Typically, a crew of two operators and one truck can clean up to 50 traps per day. Frequency of cleaning depends on litter loads. Cleaning is required at intervals of 4–6 weeks in areas with high loads.

*See also:* Grated entrances.

### *References and further information*

- Allison, R.A., Rooney, G.R., Chiew, F.H.S. and McMahon, T.A., 1997, 'Field trials of side entry pit traps for urban stormwater pollution control'.
- Allison, R.A., Walker, T.A., Chiew, F.H.S, O'Neill, I.C. and McMahon, T.A., in press, *From Roads to Rivers: Gross Pollutant Removal From Urban Waterways*.
- Hall, M.D. and Phillips, D.I., 1997, 'Litter generation and distribution in commercial and strip shop catchments'.



### Primary treatment Type 3: Baffled pits

#### Description

Baffled pits (trapped street gullies or catch basins) are modified stormwater pits fitted with baffles. The baffles are specifically designed to encourage heavy sediments to settle and floating debris to remain in the pit (Gibson and Evernden 1992). Used widely in Europe and North America in both stormwater and combined sewer system applications, baffled pits have been most commonly used to reduce sediment loads to combined sewers. In Australia, they have been used in central business district of Sydney.

The contents of the pits are removed with a large diameter vacuum device during maintenance. In the Sydney City Council region, this is performed every three weeks.

#### Advantages

- can be used as a pre-treatment for other measures;
- can be retrofitted into existing drainage systems, particularly on roads with high traffic volumes;
- minimal visual impact as installed underground; and
- can prevent odours exiting the drain.

#### Limitations

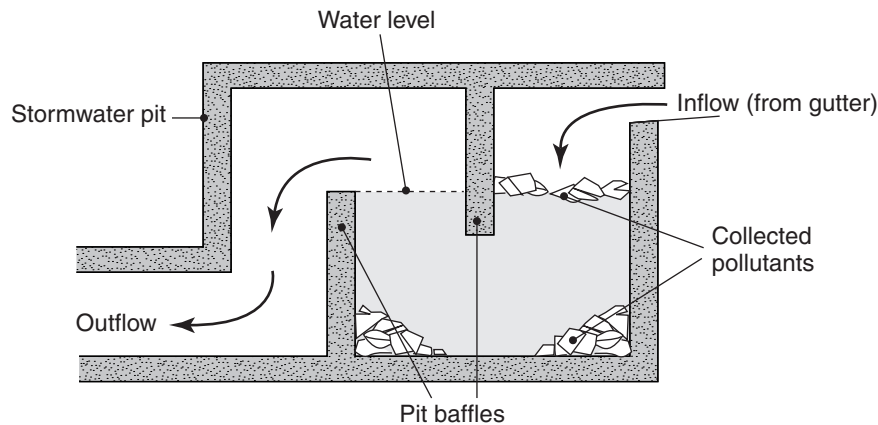
- some designs have a potential to resuspend sediments;
- potential release of nutrients and heavy metals from sediments;
- potential for scouring of collected pollutants during high flows,
- requires regular maintenance, due to the trap's limited holding capacity;
- poor retention of material that is entrained in the flow;
- reduces or eliminates air supply to the drainage network downstream of the pit; and
- large retention pit capacity is required for effective pollutant removal.

Estimated treatment performance summary					
gross pollutants	L	coarse sediment	M	medium sediments	L/M
fine sediments	L	attached pollutants	N	dissolved	N
installation costs	L/M	maintenance costs	L/M	head requirements	L
N = negligible, L= low, M = moderate, H = high, VH = very high					

#### Trapping performance

Baffled pits are best suited to trapping highly buoyant contaminants or heavy, easily settleable solids.

Conventional baffled pits often have limited sediment retention capacity due to the turbulence associated with inflows. Desorption of pollutants under anaerobic conditions



**Figure 7.8** Section view of a baffled pit.

has also been reported. As a consequence, conventional baffled pits can discharge pollutants during and following large storm events, particularly if maintenance is poor.

Recent design developments have addressed a number of these concerns, particularly relating to minimising turbulence within the basin.

#### *Cost considerations*

Baffled pits are inexpensive to install, but maintenance costs are moderate to high.

#### *Design considerations*

There are no formal guidelines for baffled pit sizing, although Ontario Ministry of Environment and Energy (OMEE) (1994) suggests the following guidelines for a proprietary system:

- a maximum catchment area of 1 hectare; and
- a wet pool volume of 15 cubic metres per impervious hectare.

#### *Maintenance*

Regular pit inspections are required to determine optimal cleaning frequencies. To prevent build-up that may lead to scouring, regular removal of trapped pollutants is an essential component of the treatment's success.

*See also:* Circular settling tank, Side entry pit traps, In-line litter separator.

#### *References and further information*

Evernden, J., 1995, 'Trapped Street Gullies' in *Better Management Practices for Urban Stormwater*.

Gibson, T.G. and Evernden, J.A., 1992, *Trapped Street Gullies*.

Grottker, M., 1989, 'Pollutant Removal by Catch Basins in West Germany: State of the Art—New Design'.

Jarett, P. and Godfrey, P., 1995, *The Role of Catch Basins in Urban Stormwater Management*.

Ontario Ministry of Environment and Energy, 1994, *Stormwater Management Practices Planning and Design Manual*.

## Primary treatment Type 4: Litter collection baskets

### Description

North Sydney City Council developed a stormwater litter trap in response to publicity surrounding a clean-up campaign in 1992 (Cooper 1992). By 1995 it had constructed nine devices (Brownlee 1995). The traps are located in pits in the drainage network, with catchment areas ranging from 2 to 145 hectares. Each consists of a steel frame supporting a metal basket of approximately one cubic metre. Large units can incorporate multiple baskets.

The basket, a sheet steel assembly with an array of 30 millimetre diameter holes in the sides, sits below the invert of the inlet pipe. Water falls into the basket and flows out through the holes. Pollutants larger than the basket's 30 millimetre pore size are retained. As the material builds up, the effective pore size is reduced, allowing smaller material to be caught (Hocking 1996).

To accommodate the basket, a one metre drop in the channel bed from inlet to outlet is required. This limits their applicability in low lying areas.

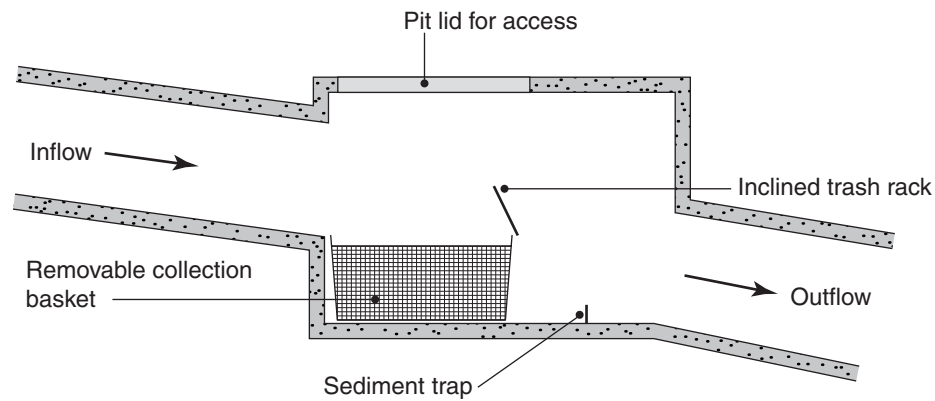
### Advantages

- can be retrofitted into existing drainage systems;
- potentially useful in areas with high litter loads;
- easy to maintain;
- can be used as pre-treatment for other measures; and
- minimal visual impact as installed underground.

### Limitations

- limited to sites where a one metre drop in the channel bed is possible;
- can cause upstream flooding if blocked;
- hydraulic head loss occurs, particularly for baskets installed in the base of pits;
- presents a possible source of odours and health risk to cleaning crews; and
- previously caught material may be resuspended if overtopping occurs.

Estimated treatment performance summary					
gross pollutants	M/H	coarse sediment	L/M	medium sediments	N
fine sediments	N	attached pollutants	N	dissolved	N
installation costs	M/H	maintenance costs	M/H	head requirements	M/H
N = negligible, L = low, M = moderate, H = high, VH = very high					



**Figure 7.9 Litter collection basket (after Brownlee 1995).**

### *Trapping performance*

The effectiveness of litter collection baskets in trapping gross pollutants varies greatly (Brownlee 1995, Hocking 1996). Problems with floating materials in tidal areas and high discharges are cited as possible reasons for material passing the traps. Inclined trash racks have also been used at the downstream end of particular litter control device installation, to collect material scoured from the baskets.

Effectiveness is highly dependent on cleaning frequency. With weekly cleaning, litter collection baskets can achieve capture rates of up to 80 per cent (Hocking 1996).

In addition to gross pollutants, litter collection baskets may also collect coarse sediment and gravel, as the pores of the collection basket are often covered with large gross pollutants (Hocking 1996).

### *Cost considerations*

Litter collection baskets are expensive to construct. Brownlee (1995) estimates installation costs of between \$50,000 and \$130,000 each for the nine installations in the North Sydney City Council area. Annual maintenance costs were estimated to be approximately \$1200 per year per trap using monthly cleaning (Brownlee 1995).

### *Design considerations*

There are currently no formal design guidelines for litter baskets. The primary design consideration is to ensure that the baskets do not significantly impact on pit or pipe system hydraulics when fully blocked.

### *Maintenance*

Litter collection baskets require regular maintenance, particularly after major storm events and in early autumn in areas with deciduous trees.

The devices are cleaned by hoisting the collection basket out of the pit by crane, then dumping into a disposal truck. The design of the basket allows simple emptying of the

contents into the disposal vehicle. Alternatively, the baskets may be emptied with vacuum plant. Sediment may also need to be removed from the control pit.

*See also:* Return flow litter baskets.

#### *References and further information*

Brownlee, R.P., 1995, 'Evaluation of effectiveness and efficiency of North Sydney litter control device program'.

Cooper, G., 1992, 'Hayes Street litter control pit'.

Hocking, J., 1996, 'Evaluation of effectiveness and efficiency of Smoothey Park litter control device'.

### **Primary treatment Type 5: Boom diversion systems**

#### *Description*

Boom diversion systems comprise of a vertically hinged floating boom located in the stormwater flow path. They were primarily designed to capture floating material, with syringes identified as the target pollutant. Under low to medium flow conditions, the boom diverts all of the flow to a screened off-line pollutant collection chamber. Floating pollutants are trapped in the chamber using a similar trapping technique to that used in baffled pits (refer Primary treatment Type 3) and heavy pollutants sink to the bottom of the chamber. Under high flow conditions, the boom raises and deflects only buoyant items. Under these conditions, the majority of the flow bypasses the trap under the boom and is prevented from scouring collected pollutants.

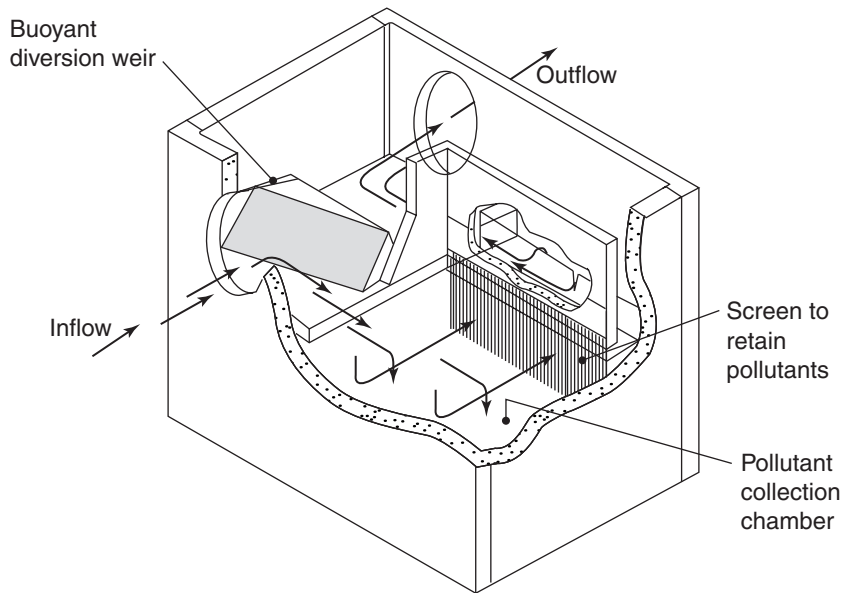
Cleaning is performed by routinely vacuuming the contents of the collection chamber—typically monthly, but it can be up to every three months. These devices are currently being tested in Victoria.

#### *Advantages*

- simple to retrofit into existing drainage systems;
- can potentially retain small oil spills;
- minimal visual impact as installed underground; and
- precast units permit easy installation.

#### *Limitations*

- booms capture only floating pollutant load during moderate to high flows;
- moving parts of the raiseable boom require inspection and maintenance;
- potential for scouring if excessive build-up of pollutants occurs; and
- potential breakdown of collected pollutants in wet sump.



**Figure 7.10 Sketch of the in-line litter separator during low flows (CSR Humes 1999).**

Estimated treatment performance summary					
gross pollutants	M	coarse sediment	L/M	medium sediments	N/L
fine sediments	N	attached pollutants	N	dissolved	N
installation costs	M	maintenance costs	M/H	head requirements	L
N = negligible, L = low, M = moderate, H = high, VH = very high					

**Trapping performance**

No field data are available on the trapping efficiency of boom diversion systems, however they have been reported as removing considerable quantities of pollutants. Laboratory observations report significant pollutant removal, but no data have been published.

Coarse sediments can easily settle and accumulate in the bottom of the retention chamber, while highly buoyant items remain trapped in its first stage. Under poor maintenance conditions, excessive sediment and pollutants may build up in the containment chamber. This can lead to pollutant scouring and remobilisation.

Several units are installed in Melbourne with some field data being collected.

**Cost considerations**

Boom diversion systems involve moderate installation costs. Operational costs are moderate to high, as they generally require monthly cleaning.

**Design considerations**

The devices need to be strategically located in urban systems, targeting those areas contributing the largest loads of floatable gross pollutants. The size of the collection chamber influences the holding capacity and hence the required cleaning frequency.

## Maintenance

Maintenance involves vacuuming the collected pollutants from the collection chamber. Inspection of the boom hinges and the inlet channel are also required.

*See also:* Baffled pits.

## References and further information

Phillips, D.I., 1997, 'A new GPT for urban drainage systems: the In-line Litter Separator'.

## Primary treatment Type 6: Release nets

### Description

Release net systems involve securing a net over the outlet of a drainage pipe. Stormwater flows through the net and material larger than the pore size of the net is retained. The net is in the shape of a cylinder and the length can vary from catchment to catchment. Gross pollutants collect in the netting until such time as the net becomes either blocked or so full as to affect upstream water levels. If upstream water levels rise, a mechanism is triggered that releases the net from the drain outlet. The net then detaches from the drain and moves a short distance downstream until the net opening chokes on a short tether which is fixed to the side of the drain.

### Advantages

- low installation costs;
- simple to install at pipe outlets;
- volume of netting and pore size can be easily altered; and
- easy to maintain involving no manual handling of pollutants.

### Limitations

- can be visually unattractive;
- could be exposed to vandalism; and
- potential odours from collected pollutants.

Estimated treatment performance summary					
gross pollutants	M/H	coarse sediment	N/L	medium sediments	N
fine sediments	N	attached pollutants	N	dissolved	N
installation costs	L	maintenance costs	L/M	head requirements	L
N = negligible, L = low, M = moderate, H = high, VH = very high					

### Trapping performance

There are no independent performance data available for this type of system.



**Figure 7.11 Release nets installed on a Sydney drain outlet.**

The trapping performance will be directly related to the pore size of the netting and the frequency that the net releases from the drain outlet. The release frequency will be affected by the size of the netting (the length), the pollution loads and the cleaning frequency. The device is expected to remove the majority of gross pollutants during times when the nets remain fixed to the pipe outlet.

#### *Cost considerations*

Compared to other primary treatments, release nets require small capital investment. Maintenance is expected to be at least monthly but will vary depending on the catchment and type of netting used.

#### *Design considerations*

The key design question is the capacity of the net compared to the expected gross pollutant load from the catchment. If the net is too small it will release too often and pollutants will pass by. It may require some monitoring of early installations to determine the optimal net size for a particular catchment.

#### *Maintenance*

Maintenance is performed by manually releasing the nets from the pipe, lifting (using a small crane) the tethered net bag on to a removal truck and fitting the pipe with a clean net. Typically two nets are provided per installation so that pollutants can remain inside the net until disposed of.

The initial stages of operation should be monitored to determine the frequency of maintenance. Monitoring would also include an inspection of the release catch to ensure its operation.



## Primary treatment Type 7: Trash racks

### *Description*

Trash racks are installed in storm drainage channels to intercept floating and submerged objects. They generally consist of either vertical or horizontal steel bars (typically spaced 40 to 100 millimetres apart) and are cleaned manually. Trash racks provide a physical barrier in the stormwater flow path, retaining pollutants larger than the bar spacings. As material builds up behind the trash rack finer material also accumulates (Nielsen and Carleton 1989).

Trash racks can be either on-line or off-line. On-line trash racks are placed within an existing channel or drainage system. As these fit within the existing bounds of the drainage system, this is usually the preferred option for established urban areas where space is limited.

Off-line arrangements consist of a flow diversion mechanism that directs low and medium flows into the trash rack, while high flows bypass the structure. This enables contaminant material from the majority of flows to be retained, whereas on-line structures are prone to overtopping. Under conditions of high flow, on-line systems can lose the waste collected since the last cleaning.

### *Advantages*

- may be used to trap litter upstream of other treatment measures or waterways;
- can be retrofitted into existing drainage systems;
- collects litter at a single location rather than over a large area;
- simple to construct; and
- can also trap coarse sediments when the trash rack becomes partially blocked.



**Figure 7.12** Trash rack (Cup and Saucer Creek, Sydney).

*Limitations*

- can cause upstream flooding;
- previously caught material may be entrained if overtopping occurs;
- difficult to maintain and requires manual maintenance;
- appearance of the rack and trapped litter can be obtrusive;
- presents a possible source of odours and health risk to cleaning crews; and
- material may be resuspended due to tidal effects in tidal channels.

<b>Estimated treatment performance summary</b>					
gross pollutants	L	coarse sediment	L/N	medium sediments	L/N
fine sediments	N	attached pollutants	N	dissolved	N
installation costs	M	maintenance costs	L/M	head requirements	L/M
N = negligible, L= low, M = moderate, H = high, VH = very high					

*Trapping performance*

The main disadvantage of the trash rack is its inability to self-cleanse (Nielsen and Carleton 1989; Beecham and Sablatnig 1994; Freeman 1996). Although trash racks are designed to continue operating while partially blocked, trash rack overtopping is common (McKay and Marshall 1993).

As more material is retained behind the trash rack’s bars, less water can pass through. The water level behind the trash rack rises until the bars are overtopped. When water flows over the top of the rack, it carries not only incoming gross pollutants but also gross pollutants that have accumulated behind the screen. The backwaters behind a blocked trash rack reduce flow velocities and allow sediments to settle, further contributing to the blockage.

Trash racks have been installed in almost all major cities in Australia. Limited performance data suggest trapping efficiencies between 5 and 14 per cent for floating items (McKay and Marshall 1993).

There have been various failed attempts to develop a self-cleaning trash rack. Techniques have included: widening the bar spacing and angling the screen to the flow (Nielsen and Carleton 1989); angling the rack across the channel bed; using horizontal bars along the rack; and a combination of angling the rack and horizontal bars along the rack (Beecham and Sablatnig 1994; Sim and Webster 1992). Vibrating the trash racks has also been tested.

Designs have been developed which provide for gross pollutants to be pushed by the flow along the racks to a collection point. Results have shown only minor improvements for these configurations.

### *Cost considerations*

Trash racks can be expensive to install and maintain. Three racks in Sydney cost between \$215,000 and \$305,000 each to install and between \$22,000 and \$70,000 each to maintain annually. These were installed in catchment areas of between 50 and 500 hectares in size.

### *Design considerations*

The original design for trash racks involved a rack across a channel fitted with vertical bars (Beecham and Sablatnig 1994; Phillips 1992; Willing and Partners 1992a).

More advanced trash rack configurations have been developed over the years, including a stepped and staggered trash rack proposed by Freeman (1996).

### *Maintenance*

The required maintenance program for trash racks is to clean either on demand or during programmed works. Although manual cleaning of trash racks is expensive, time consuming and potentially dangerous, no automated techniques have been developed to date.

*See also:* GPTs, Hydraulically operated trash rack, Downwardly inclined screens.

### *References and further information*

ACT Government, 1994, *Urban Stormwater: Standard Engineering Practices*.

Beecham, S.G. and Sablatnig, S.J. 1994, 'Hydraulic modelling of stormwater trash racks'.

Freeman, G., 1996, 'Off-line improvement of in-line stormwater quality controls'.

McKay, P. and Marshall, M., 1993, *Backyard to Bay: Tagged Litter Report*.

Molinari, S. and Carleton, M., 1987, 'Interception and collection of litter in urban waterways'.

Nielsen, J.S. and Carleton, M.G., 1989, 'A study of trash and trash interception devices on the Cooks River catchment, Sydney'.

Phillips, B.C., 1992, 'A review of design procedures for gross pollutant traps and water pollution control ponds'.

Sim, R.I. and Webster, J.L., 1992, 'Performance of trash rack on Cup and Saucer stormwater channels'.

Willing and Partners, 1992a, *Design Guidelines for Gross Pollutant Traps*.

## **Primary treatment Type 8: Gross pollutant traps**

### *Description*

A gross pollutant trap (GPT) is a sediment trap with a trash rack, usually constructed of vertical steel bars, located at the downstream end of the trap. GPTs are primarily designed to remove litter, debris and coarse sediments. They generally consist of a large concrete lined wet basin upstream of a weir, with a trash rack located above the weir (Willing and Partners 1992a).



**Figure 7.13 Gross pollutant trap, Tuggeranong Lake, Canberra.**

GPTs permit coarse sediments to settle to the bottom by decreasing the stormwater flow velocity. This is achieved by increasing the width and depth of the channel in the GPT wet basin. The trash rack at the downstream end of the basin is intended to collect floating and submerged debris in the same way as a conventional trash rack.

#### *Advantages*

- can provide coarse sediment and gross pollutant pre-treatment for other stormwater treatments;
- small traps can be located underground, minimising visual impacts; and
- offers a larger rack area than conventional trash racks, thereby improving removal rate.

#### *Limitations*

- the trash rack can suffer blockages;
- high construction costs;
- difficult and expensive to clean;
- hydraulic head loss occurs through the trash rack;
- can cause upstream flooding during trash rack blockages;
- the appearance of the rack and trapped litter can be obtrusive;
- potential breakdown of collected pollutants in wet sump;

- retrofitting can be difficult due to land and topographic requirements; and
- previously caught material may be resuspended if overtopping occurs.

<b>Estimated treatment performance summary</b>					
gross pollutants	L/M	coarse sediment	M/H	medium sediments	M
fine sediments	L	attached pollutants	N	dissolved	N
installation costs	H	maintenance costs	M/H	head requirements	H
N = negligible, L= low, M = moderate, H = high, VH = very high					

### *Trapping performance*

Although similar in principle, gross pollutant traps have some operational advantages over conventional trash racks. Entrance channels to the GPT are widened to match the width of the sedimentation basin. This ensures the trash rack located on the downstream end of the basin provides more trash rack area for a given stormwater channel width than conventional trash racks. This presumably results in improved performance and fewer blockages.

GPTs are primarily sized according to sediment retention capacity. Better performance for coarse rather than fine sediments is reported, however only a few studies have investigated their trapping efficiencies.

### *Cost considerations*

GPTs are expensive structures to construct, mainly because of their size. A large proportion of the building costs relate to infrastructure costs such as access roads. This means that larger GPTs demonstrate reduced cost per hectare of catchment. GPT maintenance is also an expensive operation. This can involve heavy machinery for sediment removal and manual labour for trash rack cleaning.

### *Design considerations*

The GPT comprises three basic functional elements: a trash rack, an apron and a slow draining pool as a sediment trap. This may be a permanent pool, or it may drain to a dry condition. A litter drying area and a flow bypass for cleaning may also be incorporated into the design. Smaller GPTs can be installed below ground to reduce visual impacts. Configurations can be based on the ACT Government guidelines (1994).

The design techniques used for sediment traps (refer Appendix B) may be applied to the sediment storage component of a GPT. The GPT's trash rack may be sized using the conventional trash rack design approach.

### *Maintenance*

GPT maintenance is an essentially manual task involving frequent litter removal and can prove to be a considerable cost. This usually involves manual scraping of pollutants from the screen or a frequent (e.g. monthly) basis. Removing the collected sediment involves

dewatering the wet basin, then using a machine to remove the material (ACT Government 1994). Typically this is done every six months.

*See also:* Trash racks, Sediment settling basin.

### References and further information

ACT Government, 1994, *Urban Stormwater: Standard Engineering Practices*.

Freeman G., 1995, 'Off-line improvement of in-line stormwater quality controls'.

Sim, R.L. and Webster, J.L., 1992, 'Performance of a trash rack on Cup and Saucer Creek stormwater channel'.

Southcott, P.H., 1995, 'A case study of a minor gross pollutant trap'.

Willing and Partners, 1992a, *Design Guidelines for Gross Pollutant Traps*.

## Primary treatment Type 9: Return flow litter baskets

### Description

The return flow litter basket comprises an inlet area with weir, leading to a labyrinth litter basket assembly. Water passes through the labyrinth, exiting very near the inlet weir. This device uses the force of 'return flow' water leaving the collection basket to produce a 'hydraulically driven barrier' to divert incoming water into the collection basket. The process operates for all flows except large floods, when flows greater than the basket capacity by-pass the system to avoid scouring of collected pollutants.

The submerged outlet permits some oils and grease to be retained in the pollutant collection chamber. The device is intended to be installed in existing pipe systems, with minimal disturbance to the flow capacity or established flow patterns.

### Advantages

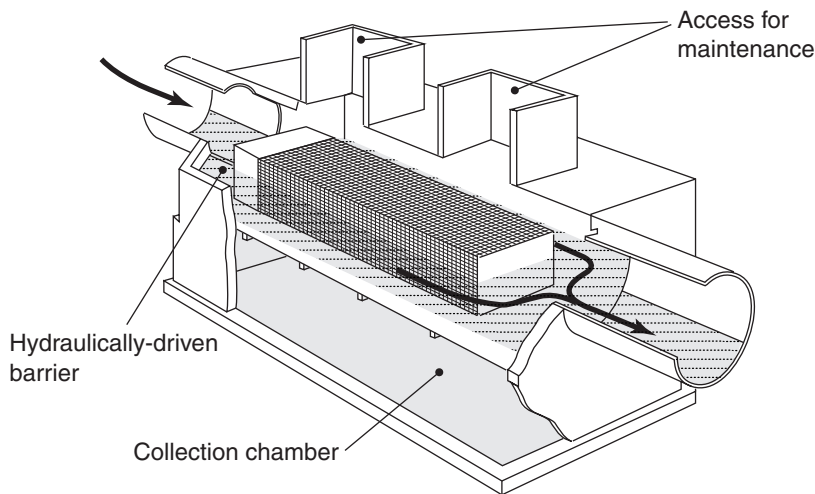
- can be retrofitted into existing drainage systems;
- hydraulically driven barrier minimises head losses;
- can operate in a range of pipe slopes; and
- only requires standard maintenance plant.

### Limitations

- potentially large structure requiring substantial area for installation; and
- potential breakdown of collected pollutants.

Estimated treatment performance summary					
gross pollutants	M/H	coarse sediment	M	medium sediments	L
fine sediments	N	attached pollutants	N	dissolved	N
installation costs	M/H	maintenance costs	L/M	head requirements	L

N = negligible, L = low, M = moderate, H = high, VH = very high



**Figure 7.14 Return flow litter baskets (after Ecosol 1997).**

### *Trapping performance*

There are few field data available on the performance of these devices, although laboratory tests have shown encouraging results. Several devices have been installed in South Australia and data are being collected.

### *Cost considerations*

Installation costs are estimated to be moderate to high, depending on site constraints. Maintenance costs are undetermined at this stage.

### *Design considerations*

The key design consideration is the sizing of the basket and pollutant retention chamber. This depends on the catchment flow characteristics and the expected pollutant loads. This size will also affect the cleaning frequency required.

### *Maintenance*

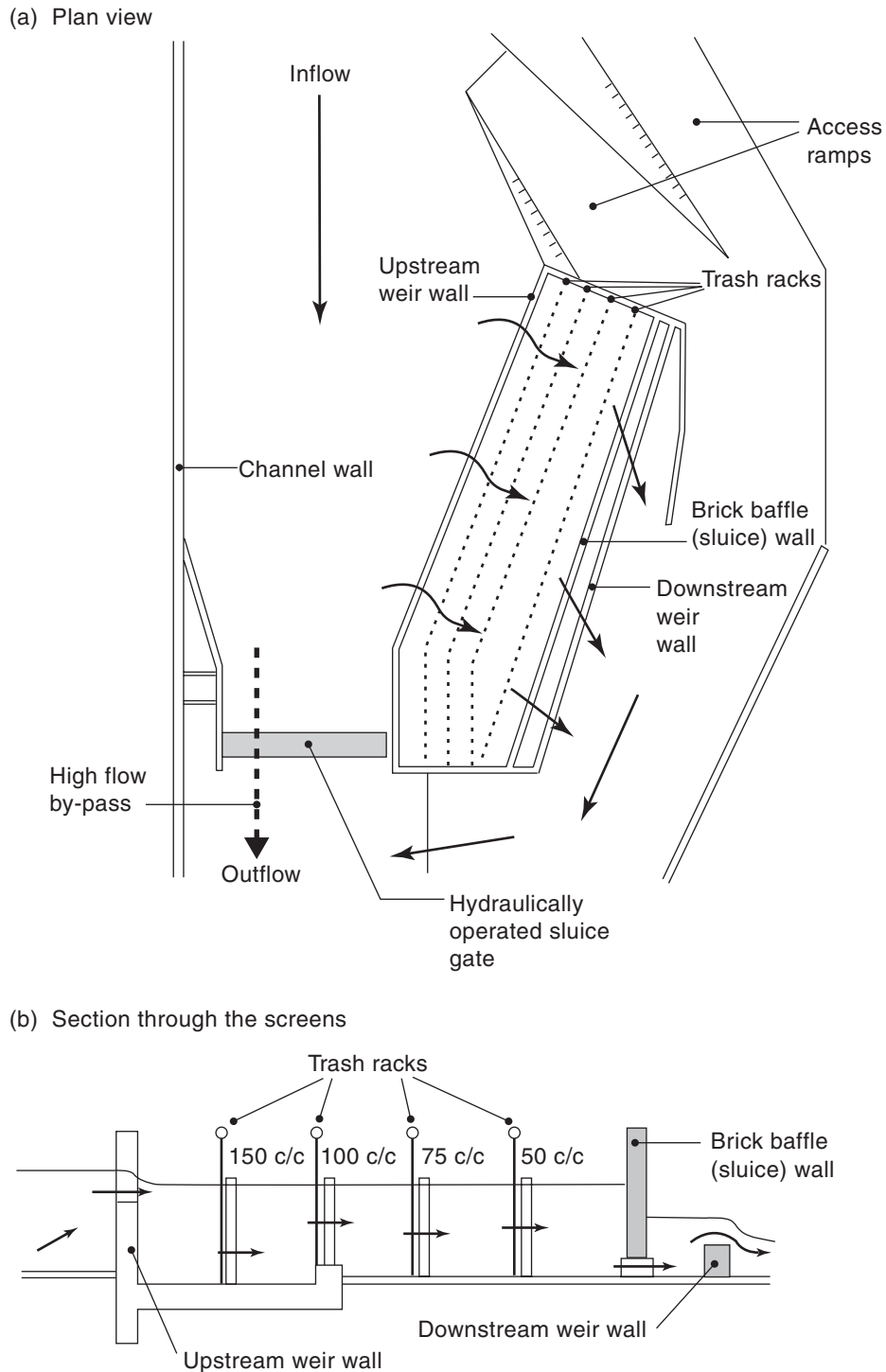
Maintenance is performed by lifting the basket with standard plant on to a collection vehicle. Alternatively, pollutants may be removed with vacuum plant. The cleaning frequency is currently unknown, but expected to be in the order of monthly.

*See also:* Litter collection baskets.

## **Primary treatment Type 10: Hydraulically operated trash racks**

### *Description*

Developed in South Africa in 1996, this device uses a hydraulically driven sluice gate to control hydraulic conditions. Stormwater is filtered through a series of vertical screens before flowing under a fixed brick baffle wall, then over a weir (Armitage et al. in press). The hydraulically operated sluice gate is activated during flood conditions, allowing flood waters to pass through the device without disturbing the collected pollutants.



**Figure 7.15 Hydraulically operated trash racks (after Townshend 1996).**

The screen assembly is positioned with the coarsest screen (150 millimetre bar spacings) upstream and the finest (50 millimetre bar spacings) on the downstream side. The South African structures also have sedimentation basins built into the device to further improve pollutant retention.

**Advantages**

- minimal head losses, permitting installation in mildly sloped channels;



- high flow by-pass avoids pollutant scouring;
- flow through the screens is maximised and regulated by the hydraulic sluice gate;
- presents a larger screen area to the flow than conventional trash racks; and
- suitable for installation in large open channels.

*Limitations*

- maintenance intensive, requiring screen cleaning and sluice gate inspection/maintenance;
- potentially large structure requiring substantial area; and
- the appearance of the rack and trapped litter can be obtrusive.

<b>Estimated treatment performance summary</b>					
gross pollutants	H/VH	coarse sediment	L/M	medium sediments	N
fine sediments	N	attached pollutants	N	dissolved	N
installation costs	L/M	maintenance costs	M/H	head requirements	L
N = negligible, L= low, M = moderate, H = high, VH = very high					

*Trapping performance*

This assembly presents a larger screen area to the flow than conventional trash racks and presumably captures more gross pollutants. It also provides water level control to avoid overtopping of the screens, further improving pollutant retention. High trapping efficiencies are reported in South Africa.

One South African structure installed on a 10 metre wide channel, can reportedly pass approximately 15 cubic meters per second through the trash rack before the flood control gate needs to be opened. The trapping performance is greatly improved compared to conventional trash racks, due to the flow regulation provided by the sluice gate.

The trapping performance is also greatly influenced by the cleaning frequency. It is essential that the structure is clean prior to large stormflows.

*Cost considerations*

Considering their ability to treat large catchment areas with a high pollutant removal efficiency, these devices may be more cost effective than conventional trash rack designs.

*Design considerations*

There are several design parameters which determine the traps' effectiveness. The flow rate at which the flood relief gate opens, the screen bar spacings and the size of the collection area.

### *Maintenance*

Intensive maintenance of this measure is required to ensure filter screens are clean—particularly before large stormflows. The screens are designed to be raised in their frame, allowing the debris to be easily removed by raking. This is currently performed manually, which is a laborious and potentially dangerous task. By increasing the space between the screens, automated techniques may be feasible.

*See also:* Trash racks.

### *References and further information*

Armitage, N.P., Rooseboon, A., Nel, C. and Townshend, P., in press, 'The removal of trash from stormwater conduits'.

Townshend, P., 1996, 'Robinson Canal: Johannesburg, Pollution Control Works'.

## **Primary treatment Type 11: Circular screens**

### *Description*

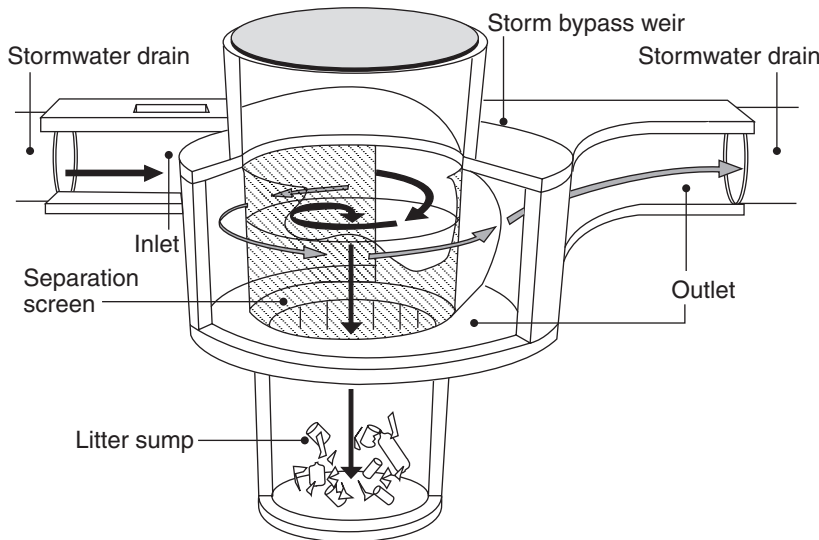
A circular screen is used to achieve separation of incoming stormwater from gross pollutants which are contained in a separation chamber. Solids within the chamber are kept in continuous motion and are prevented from 'blocking' the screen. This is achieved by a hydraulic design that ensures the circular flow force on an object is significantly higher than the centrifugal force driving the object to the chamber wall. Floating objects are kept in continuous motion on the water's surface, while the heavier pollutants settle into a containment sump.

### *Advantages*

- very high removal rate;
- low head requirements;
- can be retrofitted into existing drainage systems;
- minimal visual impact as typically installed underground;
- traps coarse sediment, with some fine sediment also retained;
- units with submerged screens can also retain oils; and
- minimal maintenance requirements.

### *Limitations*

- expensive to install;
- potentially large structure requiring substantial area and depth; and
- potential breakdown of collected pollutants in wet sump.



**Figure 7.16** Continuous deflective separation trapping system (after CDS Technologies 1997).

Estimated treatment performance summary					
gross pollutants	VH	coarse sediment	H	medium sediments	M
fine sediments	L/M	attached pollutants	L	dissolved	N
installation costs	H	maintenance costs	M	head requirements	L
N = negligible, L = low, M = moderate, H = high, VH = very high					

### Trapping performance

Field monitoring by Allison et al. (1996) suggests that circular screen devices are efficient gross pollutant traps. During the twelve months of monitoring, practically all gross pollutants transported by the stormwater were trapped by the CDS device.

Longer term trapping rates will be determined by the height of the bypass weir. Typical installations accommodate at least a one-in-six-months storm prior to overflow. This would ensure that at least 95 per cent of annual discharge is treated, with a similar proportion of all gross pollutants captured.

Monitoring by Walker et al. (1999) suggests that the devices also retain significant quantities of sediment. Ninety per cent of the sediment recovered from the collection sump was smaller than the screen mesh size. In addition, up to 70 per cent retention of suspended sediment by the device was reported during the early flows of a run-off event.

### Cost considerations

Circular screen self-cleaning racks are expensive to install, requiring complex construction methods. Maintenance costs, on the other hand, are small because of the simple, infrequent maintenance requirements. Factory built smaller units are now also available.

### Design considerations

A diversion structure upstream of the unit diverts flow to the collection chamber and acts as a by-pass weir during flow events exceeding design conditions.

The height of the weir determines the frequency of stormwater by-pass. The height of the weir depends on a number of factors, including the topography of the site, depth of cover of the existing pipe and the discharge capacity of the stormwater system. The diversion weir is typically designed to divert at least 95 per cent of annual discharge through the separation chamber (Wong et al. 1996).

### *Maintenance*

Material collected in the separation chamber can be removed in three ways. The sump can be fitted with a large basket that collects sinking material—this can be lifted with a crane on to a removal truck. Alternatively, the contents of the sump can be extracted with a vacuum pump. For very large installations, a ‘clam grab’ can be used with a crane to remove pollutants. A two- to three-monthly cleaning frequency is recommended.

*See also:* Sediment removal, Secondary treatments.

### *References and further information*

Allison, R.A., Wong, T.H.F. and McMahon, T.A., 1996, ‘Field trials of the polluted storm-water pollution trap’.

Walker, T.A., Allison, R.A., Wong, T.H.F. and Wootton, R.M., 1999, *Removal of Suspended Solids and Associated Pollutants by a CDS Gross Pollutant Trap*.

Wong, T.H.F., Wootton, R.M. and Fabian, D., 1996, *A Solids Separator Using a Continuous Deflective System*.

## **Primary treatment Type 12: Downwardly inclined screens**

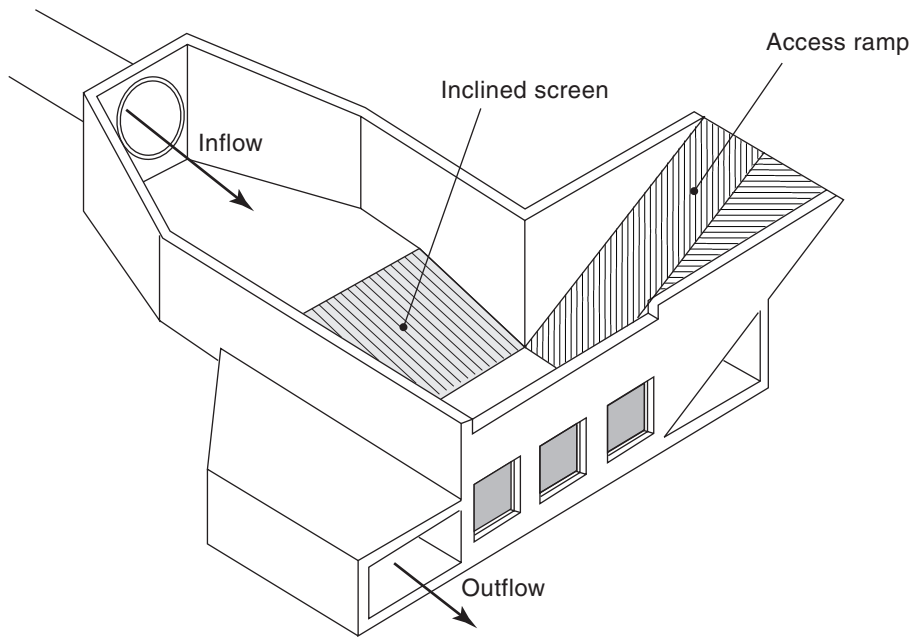
### *Description*

This measure comprises a downwardly inclined trash rack, with a pollutant holding shelf at its base. Stormwater is introduced from pipe outlets at the top of end of the assembly. The water falls between the trash rack bars, while pollutants larger than the gap width are trapped on the rack. The force of the flowing water and gravity cause the pollutants to slide down the rack on to the holding shelf at the foot of the rack. Racks are typically inclined between 20 and 45 degrees from horizontal.

The device is constructed so that maintenance can be performed with standard plant. Maintenance access is achieved via a ramp. The holding shelf allows water to drain from collected material. This simplifies the cleaning process and prevents material being stored in anaerobic conditions, which can lead to contaminant breakdown.

Independent research programs in Australia and South Africa have developed devices that are very similar. The Australian devices are intended for drains generally smaller than 1500 millimetres in diameter (Baramy 1997) using a rack inclined at approximately 20 degrees from horizontal. Some larger devices are also being developed.

The South African devices (Manly Hydraulic Laboratory 1994) cater for similar pipe sizes along with much larger channels. With screens inclined at angles typically 45 degrees



**Figure 7.17 Downwardly inclined screen pollutant trap (after Baramy 1997).**

from horizontal, these devices require more head to operate than the Australian version. The South African devices allow for installation off-line to the main channel and can be installed in very large open channels.

*Advantages*

- screen is kept free from blockages so flooding is avoided;
- pollutants are kept dry before removal;
- easy to maintain with standard plant;
- relatively simple to install; and
- potentially high trapping efficiencies.

*Limitations*

- limited to sites where a suitable drop in the channel bed is possible; and
- potentially large structure requiring substantial area.

<b>Estimated treatment performance summary</b>					
gross pollutants	H/VH	coarse sediment	N	medium sediments	N
fine sediments	N	attached pollutants	N	dissolved	N
installation costs	M/H	maintenance costs	L/M	head requirements	H
N = negligible, L= low, M = moderate, H = high, VH = very high					

*Trapping performance*

Extensive laboratory testing (Manly Hydraulic Laboratory 1994) and field experience in South Africa suggests this is a highly effective trash rack, due to its non-blocking nature.

In addition to the rack's self-cleaning nature, blockages are further prevented by a hydraulic jump that forms up the trash rack. This jump helps break up the pollutants on the rack's surface and move them down into the collection basket (Armitage et al. 1998).

The rack's bar spacing may allow some smaller material to pass through. Bars are typically spaced at approximately 30–50 millimetre centres.

Being off-line to the main channel, the South African designs permit very large flood flows to bypass the system, leaving collected pollutants undisturbed.

To date, no Australian field data have been collected describing the trapping performance of this measure.

#### *Cost considerations*

Installation costs for these types of racks are moderate to high, depending on the location of the device. Maintenance costs are relatively low, due to the trap's self-cleaning nature. Only infrequent cleaning is required.

#### *Design considerations*

These devices are only suitable for locations that can accommodate a drop in the drainage line. This limits their applicability in low lying areas.

Australian and South African designs differ in rack angles, in-line and off-line options and the size of catchments they are designed to treat.

#### *Maintenance*

There is limited information available describing the maintenance requirements of downwardly inclined screens. They are expected to have very high trapping efficiencies for gross pollutants and can therefore expect to produce large volumes of material for collection. The trap's self-cleaning nature and the fact that pollutants are kept dry minimises the cost of this operation.

*See also:* Trash racks.

#### *References and further information*

Armitage, N.P., Rooseboon, A., Nel, C. and Townshend, P., 1998, *The Removal of Urban Litter From Stormwater Conduits and Streams*.

Baramy Engineering, 1997, Product description, Katoomba, NSW.

Manly Hydraulic Laboratory (MHL), 1994, Hydraulic Model Studies of Grate, Lintel and Modified Gully Pit Designs for Pymont Redevelopment.

### **Primary treatment Type 13: Flexible floating booms**

#### *Description*

The flexible floating boom comprises a string of partly submerged floating booms located across a waterway. Originally designed as an oil slick retention device, the boom collects



**Figure 7.18 Flexible floating boom on the Yarra River, Melbourne.**

floating objects as they collide with it. The performance of any boom is greatly influenced by the flow conditions of the waterway. Floating booms are best suited to very slow moving waters and perform best with highly buoyant pollutants such as plastic bottles and polystyrene.

#### *Advantages*

- enhances aesthetics and recreation potential of downstream waterways;
- mobile and may be appropriate for retrofitting into existing areas;
- collects litter at a single location rather than over a large area; and
- able to rise and fall with changes in flow or tide.

#### *Limitations*

- gross pollutants may be swept past the boom by tide movement, winds or high flows;
- booms can only capture floating pollutant load;
- maintenance is difficult, with most boom assemblies cleaned by boat;
- spanning of the entire waterway width may be difficult;
- booms may break away from the banks during high flows; and
- the appearance of the boom and trapped litter can be obtrusive.

<b>Estimated treatment performance summary</b>					
gross pollutants	N/L	coarse sediment	N	medium sediments	N
fine sediments	N	attached pollutants	N	dissolved	N
installation costs	L	maintenance costs	M	head requirements	L
N = negligible, L= low, M = moderate, H = high, VH = very high					

### *Trapping performance*

Despite early claims of high trapping efficiency, it has been recognised that during high flows the gross pollutant retaining performance of floating booms is greatly reduced. This is because material may be forced over and under the boom (Horton et al. 1995; Gamtron 1992), or the boom may break away from the banks.

The boom's litter retention properties can be improved by angling it across the channel to allow collected trash to accumulate on one side of the channel, away from high velocity areas (Horton et al. 1995). Mesh skirts are also useful (Horton et al. 1995). Regardless of these modifications, litter loss during high flow conditions may still occur.

The floating boom is only effective in retaining gross pollutants that float. As this represents less than 20 per cent of litter and 10 per cent of vegetation, this suggests a limited performance for floating boom applications.

Despite the boom's inefficiencies during high flows and with submerged pollutants, they have been reported to trap large quantities of gross pollutants. It has been reported that between 100 and 370 cubic metres of gross pollutants have been removed annually from booms in Melbourne (State Pollution Control Commission 1989). Gamtron (1992) quotes annual capture rates of between 24 and 71 kilograms per hectare from four booms in Sydney.

### *Cost considerations*

Flexible floating booms are comparatively inexpensive to purchase and installation is simple. Operating costs can be expensive due to the difficulty of boom cleaning operations and the necessity for continuous monitoring.

### *Design considerations*

As described earlier, boom performance can be improved by angling the boom across the channel. In addition, the trash may be collected in a mesh container attached to the side of the channel. Located within easy reach of the bank, this will retain trash during high flows and permit easier cleaning (Freeman 1995).

Waterway width and water traffic generally prevent the boom spanning the entire width of the waterway. It is therefore critical to locate a boom where the flow paths will ensure optimal boom performance.



### *Maintenance*

Floating booms generally require manual cleaning. Trash accumulated in the boom is usually collected with a trench digger or by using a boat and pitch forks. Cleaning is usually on demand.

Small booms can be pulled to one bank, where material can be accessed manually from land. Booms angled across the flow are intended to transfer collected material to a collection area that is accessible from land. This has been successful with some small booms, but not for most installations (Horton et al. 1995).

More recently, techniques have been developed to collect pollutants from behind the boom using an underwater vacuum device. This requires manual operation and is only suitable for shallow waters.

*See also:* Floating debris traps.

### *References and further information*

- Freeman, G., 1995, 'Off-line improvement of in-line stormwater quality controls'.
- Gamtron Pty Ltd, 1992, *Performance Assessment of Four Rubbish Interception Booms*.
- Horton, P.R., Cox, R.J. and Wilkinson, D.L., 1995, 'Stormwater boom performance assessment and enhancement'.
- McKay, P. and Marshall, M., 1993, *Backyard to Bay: Tagged Litter Report*.
- State Pollution Control Commission, 1989, *Pollution Control Manual for Urban Stormwater*.

## **Primary treatment Type 14: Floating debris traps**

### *Description*

Floating Debris Traps (FDTs) have evolved from booms and use the same operating principles, but have enhanced material retention capabilities and are easier to clean.

The traps use floating polyethylene boom arms fitted with skirts to deflect floating debris through a flap gate into a collection chamber. The flap gate prevents collected floatables escaping during high winds or changing tidal conditions. A sliding gate on the downstream end of the trap provides access for cleaning. A specially designed basket is used to collect material as it flows through the open gate.

### *Advantages*

- enhances aesthetic and recreation potential of downstream waterways;
- improved retention of collected pollutants;
- mobile and may be appropriate for retrofitting into existing areas;
- collects litter at a single location rather than over a large area; and
- able to rise and fall with changes in flow or tide.



**Figure 7.19 Plan view of floating debris trap.**

*Limitations*

- gross pollutants may be swept past the boom by tide movement, winds and high flows;
- booms can only capture floating pollutant load;
- maintenance is difficult, with most boom assemblies cleaned by boat;
- complete boom spanning of the waterway may be difficult;
- booms may break away from the banks during high flows; and
- the appearance of the boom and trapped litter can be obtrusive.

<b>Estimated treatment performance summary</b>					
gross pollutants	L	coarse sediment	N	medium sediments	N
fine sediments	N	attached pollutants	N	dissolved	N
installation costs	L	maintenance costs	M	head requirements	L
N = negligible, L= low, M = moderate, H = high, VH = very high					

*Trapping performance*

There is little data describing the trapping efficiency of FDTs. It is likely that the FDT suffers similar problems of material loss during high flow and wind conditions, as experienced by the floating boom. FDTs may have better material retention in changing wind or tidal conditions.

### *Cost considerations*

FDTs can be moderately expensive to purchase, but are simple to install. As with floating booms, regular monitoring and on-water removal of collected material is required, making maintenance difficult and expensive.

### *Design considerations*

As the width and boating use of most waterways generally prevents floating debris traps from spanning the complete width of a waterway, the location of the trap is critical to its performance. Governed by discharge, tide or wind conditions, the waterway's 'natural' flow paths for floating gross pollutants can either direct pollutants into or away from the trap. Knowledge of the installation site's natural flow paths and wind directions is recommended prior to installing FDTs.

### *Maintenance*

During cleaning, a sliding gate at the downstream end of the trap is opened, releasing the material to a purpose built collection basket. Once full, a specially designed barge fitted with a crane lifts the basket on-board. The basket is then taken away for disposal. Continuous monitoring of pollutant build-up is required to ensure cleaning is performed with sufficient regularity.

*See also:* Flexible floating booms.

## **Primary treatment Type 15: Sediment settling basins and ponds**

### *Description*

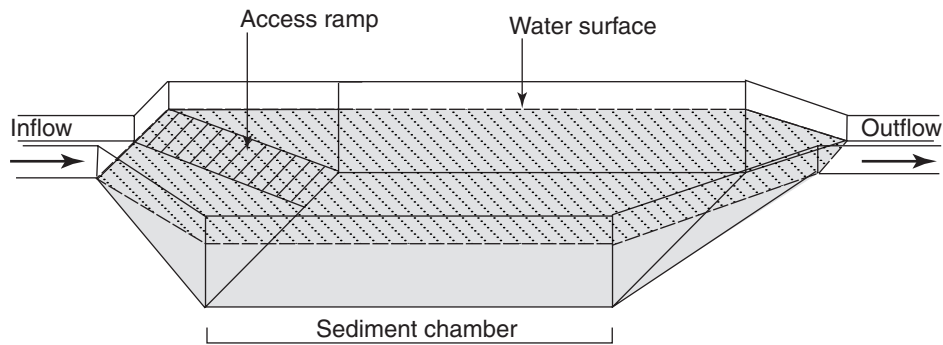
Sediment settling basins are structures designed to trap coarse sediment. These can be used in isolation in the stormwater system, or as a pre-treatment upstream of other treatment measures. The basins can take the form of a formal 'tank' (usually concrete) or a less formal pond (usually earth). Sedimentation is encouraged in the basin by enlarging the channel so that water velocities are reduced to a point where sedimentation can occur.

### *Advantages*

- simple design, making construction easy; and
- reduces stormwater coarse sediment loads.

### *Limitations*

- potential breakdown of collected pollutants in wet sump;
- limited removal of fine sediments or soluble pollutants;
- potentially large structure requiring substantial area; and
- possible source of sediments due to scouring during large floods.



**Figure 7.20 Sediment settling basin.**

Estimated treatment performance summary					
gross pollutants	N	coarse sediment	M/H	medium sediments	M
fine sediments	L	attached pollutants	N/L	dissolved	N
installation costs	L/M	maintenance costs	L/M	head requirements	L
N = negligible, L = low, M = moderate, H = high, VH = very high					

### *Trapping performance*

Originally designed and developed in Canberra, the primary design technique for sediment traps was developed by Willing and Partners (1992a, 1992b). This is detailed in ACT Government (1994). The technique has been applied in other areas and there is anecdotal evidence that the sediment trapping is less efficient than that observed in the Canberra trials.

Limited monitoring of sediment traps has been undertaken in Australia.

### *Cost considerations*

Both the installation and maintenance costs of the sediment settling basins are low to moderate.

### *Design considerations*

Sediment settling basins differ from wetlands, in that they primarily rely on physical settling rather biological means of pollutant removal. Sometimes known as sediment fore-bays, pond type sediment traps are usually of an informal shape. These are often located at the upstream end of wet basins or wetlands to provide coarse sediment removal.

Incorporated as part of a wet basin or wetlands treatment system, sediment settling basins appear as deeper pools upstream of a shallower area. Macrophytes (aquatic plants) may be used to minimise the potential for sediment resuspension and prevent the conveyance of material to the pond outlet. Pervious outlets, such as rock walls, can also be used to help filter the water and provide water level variations.

Sedimentation basin sizing is based on the settling velocity of the design particle, during the design storm event. More detailed design methods are outlined in Appendix B.

### *Maintenance*

Accumulated sediment needs to be removed regularly to prevent scouring during storms. Sediment removal becomes critical when the storage volume has been reduced by half. The best method of sediment removal is expected to involve draining the trap, followed by the use of backhoes or similar equipment. Regular inspection will help determine maintenance needs. Generally, sediment removal is required every three to six months.

*See also:* Circular self-cleaning screens, Hydrodynamic separation, Gross pollutant traps, Circular settling tanks.

### *References for further information*

ACT Government, 1994, *Urban Stormwater: Standard Engineering Practices*.

Auckland Regional Council, 1992, *Design Guideline Manual: Stormwater Treatment Devices*.

Ontario Ministry of Environment and Energy, 1994, *Stormwater Management Practices Planning and Design Manual*.

Schueler, T.R., 1987, *Controlling Urban Runoff: A Practical Manual for Planning and Designing Urban BMPs*.

Schueler, T.R., Kumble, P.A. and Heraty, M.A., 1992, *A Current Assessment of Urban Best Management Practices: Techniques for Reducing Non-Point Source Pollution in the Coastal Zone*.

Willing and Partners Pty Ltd, 1989, *Gross Pollutant Trap Design Guidelines*.

Willing and Partners Pty Ltd, 1992a, *Design Guidelines for Gross Pollutant Traps*.

Willing and Partners Pty Ltd, 1992b, *Gross Pollutant Trap Design Manual*.

## **Primary treatment Type 16: Circular settling tanks**

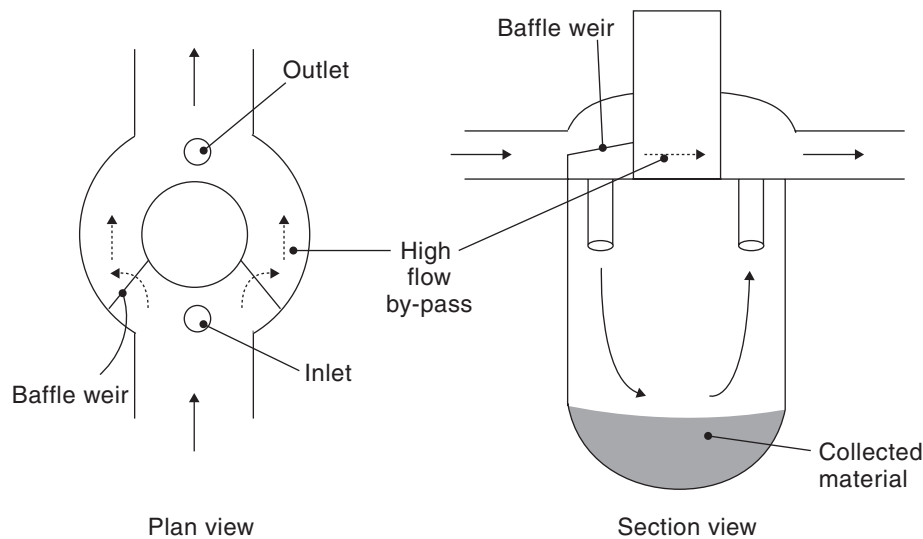
### *Description*

Circular settling tanks have been primarily designed for sediment and oil retention, although floatables and other gross pollutants may be retained during low to moderate flows.

The tank is cylindrical in shape and divided into two areas: an upper diversion chamber and a lower retention chamber. Stormwater is directed by a diversion weir into the lower retention chamber and exits the chamber through an outlet riser pipe. Sediments collect in the base of the retention chamber. The diversion weir directs flow to by-pass the retention chamber in the event of high flows. As the inlet and outlet pipes are set at the same elevation, some oil retention is achieved in the lower chamber (Weatherbe et al. 1995).

### *Advantages*

- retains a high proportion of sediments;
- protects collected material from scouring;
- can also collect oils and grease;



**Figure 7.21 Circular settling tank (after CSR Humes 1997).**

- suitable for targeting specific problem areas; and
- can be retrofitted into existing drainage systems.

*Limitations*

- high initial costs; and
- gross pollutants may block inlet downpipe.

<b>Estimated treatment performance summary</b>					
gross pollutants	L/M	coarse sediment	H	medium sediments	M/H
fine sediments	M	attached pollutants	L/M	dissolved	N
installation costs	H	maintenance costs	M	head requirements	L
N = negligible, L= low, M = moderate, H = high, VH = very high					

*Trapping performance*

A series of laboratory experiments lead to the development of circular settling tanks in the early 1990s (Marsalek 1993; Marsalek et al. 1994). A number of North American field studies have investigated the unit’s sediment retention capabilities. Bryant et al. (1995) showed field installations achieving retention of 80 per cent of all sediments.

*Cost considerations*

Circular settling tanks are expensive to install, but maintenance costs are moderate.

*Design considerations*

A key design issue is to adequately size the units to achieve the desired by-pass frequency. A 25 millimetre drop is required between the inlet and outlet channel beds for operation. This should be easily met in most situations.

### *Maintenance*

Routine vacuum removal of the retention chamber is required—typically, monthly.

*See also:* Other sediment treatments, In-line litter separator, Baffled pits.

### *References and further information*

Bryant, G., Misa, F., Weatherbe, D. and Snodgrass, W., 1995, 'Field monitoring of stormceptor performance'.

Marsalek, J., 1993, *Laboratory Testing of Stormceptor I*.

Marsalek, J., Long, R. and Doede, D., 1994, *Laboratory Development of Stormceptor II*.

Weatherbe, D.G., Bryant, G. and Snodgrass, W., 1995, 'Performance of the Stormceptor water quality inlet'.

## **Primary treatment Type 17: Hydrodynamic separators**

### *Description*

Hydrodynamic separation units induce a vortex in the stormwater flow as it enters a large separation chamber. The system relies on the secondary flows, caused by the vortex action, to concentrate sediments in the bottom of the unit.

Hydrodynamic separation units available in Australia fall into two design categories. The first simply treats the stormwater and retains the separated pollutants within the unit until it is cleaned. The second incorporates a separate drain line for the contaminants (refer Figure 7.20).

This design features two outlet lines. One carries a high volume, low concentration flow (the 'water' line), while the other is intended to remove most of the pollutants with a small amount of the flow. This is discharged into the sewerage system.

The dual outlet device is effectively self-cleaning and requires minimal maintenance. A sewer line with sufficient capacity to cope with additional flows during wet weather is required close by.

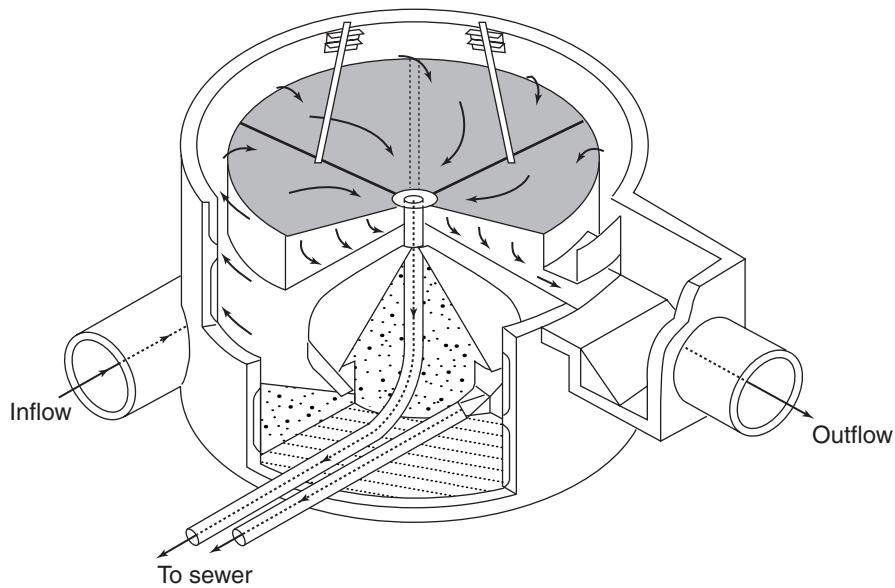
The dual outlet units can also be fitted with racks that screen the incoming water and direct gross pollutants to the sewerage system. The racks are prevented from blocking by a reverse flush system that is activated by rising water level.

### *Advantages*

- high sediment removal rates; and
- can incorporate return flows to sewers to minimise cleaning.

### *Limitations*

- expensive and complex to install;
- removal rates fall with increasing stormwater flow; and
- lack of Australian performance data.



**Figure 7.22 A hydrodynamic separator (Storm King®, after Hydro Australasia).**

Estimated treatment performance summary					
gross pollutants	L/M	coarse sediment	M/H	medium sediments	M
fine sediments	M	attached pollutants	L/M	dissolved	N
installation costs	H	maintenance costs	L/M	head requirements	L
N = negligible, L = low, M = moderate, H = high, VH = very high					

### *Trapping performance*

Extensive experience with vortex separation used in combined sewer overflows has been reported in USA and Europe. It is generally regarded as an efficient means of removing sediments, although there has been limited experience with discrete stormwater system applications.

Hydrodynamic separators have been employed in combined sewer overflows in the United Kingdom since the 1960s. Since then, American, German and British researchers have developed enhanced designs with improved sediment retention (Brombach et al. 1993).

One of the British devices previously used for combined sewer overflows in the northern hemisphere is currently promoted in Australia for stormwater applications. All such devices use similar principles and can be expected to remove significant quantities of sediments.

### *Cost considerations*

Hydrodynamic separators demonstrate high installation costs because of the complex construction requirements. Once installed, maintenance demands vary depending on the specific unit selected.



### *Design considerations*

The units are sized for hydraulic conditions and expected pollutant loads. The unit's size will have a direct impact on the required cleaning frequency.

### *Maintenance*

With simple units, maintenance involves removing collected pollutants with vacuum plant. If a foul water outlet is fitted, simple inspection of the unit to ensure the foul water outlet is operational is the only maintenance required.

*See also:* Continuous deflective separation, Circular settling tanks.

### *References and further information*

Brombach, H., Xanthopoulos, C., Hahn, H.H. and Pisano, W.C., 1993, 'Experience with vortex separators for combined sewer overflow control'.

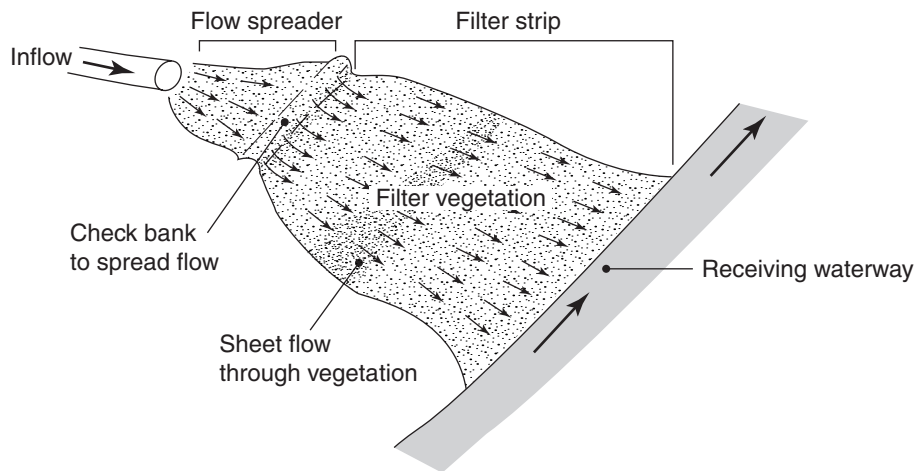
Harwood, R. and Saul, A. J., 1996, *Field Testing of a Storm King With Swirl Cleanse Hydrodynamic Separator Combined Sewer Overflow: Summary Report*.

Pisano, W.C., 1988, 'Swirl concentrators revisited: the American experience and new German technology'.

## 7.8 Secondary treatment: index

---

<b>Secondary treatment type</b>	<b>Page no.</b>
<b>Pre-entrance types</b>	
Type 1: Filter strips	172
Type 2: Grass swales	174
Type 3: Triple interceptor pits	177
Type 4: Porous pavements	180
Type 5: Infiltration trenches	182
<b>In-transit types</b>	
Type 6: Infiltration basins	184
Type 7: Extended detention basins	186
Type 8: Sand filters	189



**Figure 7.23 Filter strips.**

### **Secondary treatment Type 1: Filter strips**

#### *Description*

Also known as buffer zones or strips, filter strips are grassed or vegetated areas that treat shallow overland flow before it enters the drainage network. Often located adjacent to waterways, this treatment measure is primarily intended to remove sediment and hydrocarbons.

Filter strips initially immobilise pollutants, by binding them to organic matter and soil particles. Ultimate pollutant removal is achieved by settling, filtration and infiltration into the subsoil. Certain pollutants, such as hydrocarbons, may be digested and processed by the soil micro-organisms in the filter strip. Consequently, adequate contact time between the run-off and the vegetation and soil surface is required to optimise pollutant removal.

Filter strips also reduce run-off volumes and attenuate storm flows. With appropriate vegetative cover and diversity, filter strips can provide a habitat corridor for wildlife. Additional benefits of filter strips include improved landscape and habitat values.

#### *Advantages*

- infiltration can reduce and delay storm run-off;
- can achieve high removal rates;
- retains pollutants close to source;
- can improve the aesthetic appeal of an area; and
- relatively inexpensive to construct.

#### *Limitations*

- limited removal of fine sediment and dissolved pollutants;

- requires considerable land areas with limited public access;
- a sunny aspect is required for plant growth, limiting its application in shaded areas;
- effectiveness is reduced for concentrated flows and high flow depths;
- flow spreaders are required for slopes greater than 5 per cent;
- only suitable for gentle slopes (less than 5 per cent); and
- regular inspections are required.

<b>Estimated treatment performance summary</b>					
gross pollutants	L/M	coarse sediment	H	medium sediments	M/H
fine sediments	L/M	attached pollutants	L/M	dissolved	L
installation costs	L	maintenance costs	L	head requirements	L
N = negligible, L= low, M = moderate, H = high, VH = very high					

### *Trapping performance*

Based on a nine minute average residence time, the reported pollutant retentions are listed in Table 7.4.

<b>Pollutant</b>	<b>Retention (%)</b>	<b>Pollutant</b>	<b>Retention (%)</b>
Suspended solids	83	Lead	67
Oil and grease	75	Total phosphorus	29
Iron	72	Total nitrogen	Negligible

**Table 7.4 Pollutant retention rates for filter strips (Horner et al. 1994).**

More Australian performance data are required to properly assess pollutant removal rates.

### *Cost considerations*

Installation and maintenance costs for filter strips are both low.

### *Design considerations*

Pollutant uptake by the filter strip vegetation is negligible; its primary purpose is to act as a physical filter. The choice of plant species will be related to local soil and climatic conditions. The goal is to generate a dense vegetation growth to maximise filtration and minimise erosion. Dense vegetation coverage of the filter strip can also improve the area's habitat value, run-off attenuation and aesthetics.

Flow entering the filter strip should be evenly distributed as sheet flow across its upstream end. Filter strips should not receive direct discharges from stormwater pipes or adjacent impervious areas—these should be pre-treated with energy dissipaters and/or flow spreaders as required.

Flow spreaders such as a shallow weir, rip-rap mattresses, a stilling basin or perforated pipes may be located across the width of the strip. A strip of turf can be placed immediately downstream of the level spreader, to assist flow spreading during the establishment period of the downstream seeded area. Filter strips should not receive flow until the vegetation is established.

There are no comprehensive guidelines on the design of filter strips and a number of 'rules of thumb' have been developed (Horner et al. 1994; Schueler et al. 1992), which are outlined in Appendix C.

### **Maintenance**

The most important maintenance consideration is to preserve the vegetation cover of a filter strip. Maintenance activities can include watering, reseeding, weeding or fertilising the area. Regular inspections are required to assess the condition of the vegetation cover, the presence of any channelisation and weed problems.

*See also:* Grass swales, Infiltration trenches.

### **References and further information**

- Auckland Regional Council, 1992, *Design Guideline Manual: Stormwater Treatment Devices*.
- Camp Dresser and McKee, 1993, *California Storm Water Best Management Practice Handbooks: Municipal*.
- Horner, R.R., Skupien, J.J., Livingston, E.H. and Shaver, H.E., 1994, *Fundamentals of Urban Runoff Management*.
- Ontario Ministry of Environment and Energy, 1994, *Stormwater Management Practices Planning and Design Manual*.
- Schueler, T.R., 1987, *Controlling Urban Runoff: A Practical Manual for Planning and Designing Urban BMPs*.
- Schueler, T.R., Kumble, P.A. and Heraty, M.A., 1992, *A Current Assessment of Urban Best Management Practices: Techniques for Reducing Non-Point Source Pollution in the Coastal Zone*.
- Whelans, Halpern Glick Maunsell, Thompson Palmer and Murdoch University, 1994, *Planning and Management Guidelines for Water Sensitive Urban (Residential) Design*.
- Woodfull, J., Finlayson, B. and McMahon, T., 1992, *The Role of Buffer Strips in the Management of Waterway Pollution from Diffuse Urban and Rural Sources*.

## **Secondary treatment Type 2: Grass swales**

### **Description**

Swales are grass-lined channels often used in low density residential developments as an alternative to kerb and gutter, or as a pre-treatment to other measures. These are similar in many ways to filter strips, but are used to convey run-off. They can also be used in road medians and verges, car park run-off areas, parks and recreation areas.



**Figure 7.24 Grass swales.**

Pollutant removal is achieved in much the same way as filter strips, although grass swales convey more flow and may therefore achieve lower removal rates.

Grass swales initially immobilise pollutants, by binding them to organic matter and soil particles. Ultimate pollutant removal is achieved by settling, filtration and infiltration into the subsoil. Certain pollutants, such as hydrocarbons, may be digested and processed by the soil micro-organisms in the swale. Consequently, adequate contact time between the run-off and the vegetation and soil surface is required to optimise pollutant removal.

Grassed swales can reduce run-off volumes and peak flows and enhance infiltration.

#### *Advantages*

- can reduce and delay storm run-off;
- retains particulate pollutants close to source;
- more aesthetically appealing than kerb and gutter; and
- relatively inexpensive to construct.

#### *Limitations*

- limited removal of fine sediment and dissolved pollutants;
- requires larger land area than kerb and gutter, with certain activities restricted (e.g. car parking);
- sunny aspect is required for plant growth, limiting its application in shaded areas;

- only suitable for gentle slopes (less than 5 per cent); and
- regular inspections are required.

<b>Estimated treatment performance summary</b>					
gross pollutants	L	coarse sediment	M/H	medium sediments	M
fine sediments	L/M	attached pollutants	L/M	dissolved	L
installation costs	L	maintenance costs	L	head requirements	L
N = negligible, L= low, M = moderate, H = high, VH = very high					

### *Trapping performance*

Grass swales can achieve high removal rates, although limited Australian data exists.

### *Cost considerations*

Installation and maintenance costs for grass swales are both low.

### *Design considerations*

Generally, design considerations for grass swale areas are similar to those for filter strips (refer Secondary treatment Type 2: Filter strips).

Swales adjacent to roads may be compacted by vehicular traffic, which may cause reduced infiltration rates.

There are no comprehensive guidelines for the design of swales and a number of 'rules of thumb' have been developed (Horner et al. 1994; Schueler 1992). A number of design techniques for sizing swales are presented in Appendix C.

### *Maintenance*

The most important maintenance consideration is to preserve the vegetation cover of a swale. Maintenance activities can include watering, reseeding, weeding or fertilising the area. Regular inspections may be required to assess the vegetation cover, the presence of any channelisation and weed problems.

*See also:* Filter strips, Infiltration trenches.

### *References for further information*

- Auckland Regional Council, 1992, *Design Guideline Manual: Stormwater Treatment Devices*.
- Camp Dresser and McKee, 1993, *California Storm Water Best Management Practice Handbooks: Municipal*.
- Horner, R.R., Skupien, J.J., Livingston, E.H. and Shaver, H.E., 1994, *Fundamentals of Urban Runoff Management*.
- Ontario Ministry of Environment and Energy, 1994, *Stormwater Management Practices Planning and Design Manual*.

Schueler, T.R., 1987, *Controlling Urban Runoff: A Practical Manual for Planning and Designing Urban BMPs*.

Schueler, T.R., Kumble, P.A. and Heraty, M.A., 1992, *A Current Assessment of Urban Best Management Practices: Techniques for Reducing Non-Point Source Pollution in the Coastal Zone*.

Whelans, Halpern Glick Maunsell, Thompson Palmer and Murdoch University, 1994, *Planning and Management Guidelines for Water Sensitive Urban (Residential) Design*.

### **Secondary treatment Type 3: Triple interceptor pits**

#### *Description*

Triple interceptors, also known as oil-grit separators, generally comprise three underground retention chambers designed to remove coarse sediments and retain oils. The first chamber is used for sedimentation and removal of large debris. This chamber contains a permanent pool of water and a well screened orifice which allows regulated flow into the second chamber.

The second chamber is used for oil retention. This chamber also contains a permanent pool of water. An inverted elbow pipe in the second chamber permits regulated flow into the third chamber. The inverted pipe collects water from deep in the permanent pool, leaving any oil contaminants floating on the surface. This remains trapped on the surface of the water until it is removed or absorbed by sediment particles which settle.

The third chamber is used to collect and disperse flow into the stormwater drain network or an infiltration basin. This chamber contains an orifice outlet, which is often raised to create a third settling pool and regulate outflow from the unit.

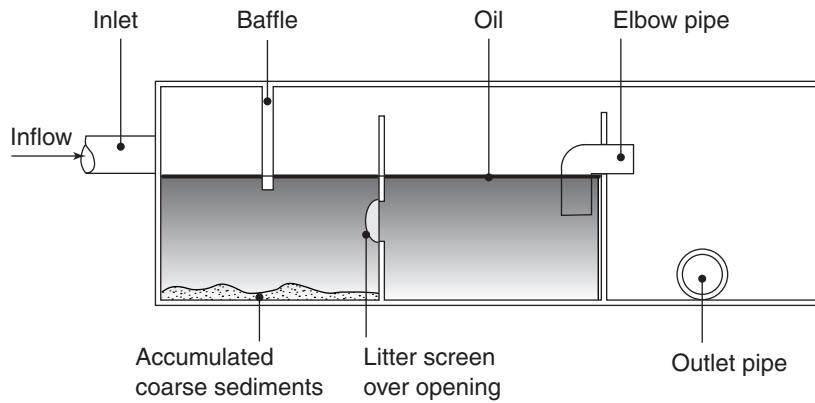
#### *Advantages*

- appropriate for treating stormwater from areas with significant vehicular pollution (e.g. parking lots);
- can also trap litter;
- can treat stormwater from areas storing or handling petroleum products (e.g. service station and petroleum depots);
- can be retrofitted into existing drainage systems; and
- minimal visual impact as installed underground.

#### *Limitations*

- limited removal of fine sediment or soluble pollutants;
- turbulent conditions in the pit may resuspend particles or entrain floating oil (a high-flow bypass can avoid this problem);





**Figure 7.25 Triple interceptor device.**

- trapped debris is likely to have a high concentration of pollutants, possibly toxic. Trapped debris may potentially release some pollutants into the stormwater;
- requires regular cleaning to achieve design objectives; and
- can pose a potential safety hazard for maintenance personnel.

Estimated treatment performance summary					
gross pollutants	L/M	coarse sediment	M	medium sediments	L/M
fine sediments	L	attached pollutants	L	dissolved	N
installation costs	M	maintenance costs	H	head requirements	L/M
N = negligible, L= low, M = moderate, H = high, VH = very high					

### Trapping performance

Triple interceptors have been reported to have relatively poor pollutant removal performance. This has been attributed to poor maintenance and the passage of high flows through the device (Galli 1992). They have often been found to be expensive to operate, due to their high maintenance requirements (Ontario Ministry of Environment and Energy 1994). They have not been widely used in Australia.

### Cost considerations

Capital costs for baffled pits are moderate, but maintenance costs are high.

### Design considerations

Ontario Ministry of Environment and Energy (OMEE) (1994) provides the following general guidelines for the design of triple interceptors:

- *Run-off segregation:* Only run-off from areas which are likely to have oil contaminated run-off (e.g. filling areas on a service station site) should be directed to the separator. This will reduce the size of the separator required. Appropriate use of bunding in such areas may help segregate oil contaminated run-off from 'clean'.

- *High flow bypass*: The separator should be designed to accept low flow only, with a high flow bypass installed to provide for the residual flow up to the capacity of the pipe system.
- *Inter chamber screening*: Ensure that orifice between primary and secondary chambers is effectively screened. This should generally not allow debris greater than 5 millimetres in diameter to enter the second chamber. It should be easily accessible and easily removed for cleaning.
- *Maintenance access*: Easy access is required for inspection and cleaning. Each chamber could have its own inspection entrance, with step rings leading to the bottom of the chamber.

### *Maintenance*

Triple interceptors need to be cleaned frequently to keep accumulated oil and grit from escaping. The recommended cleaning frequency is every month. A vacuum pump tanker can be used to pump out the contents of each chamber. The turbulence of the vacuum pump in the chamber produces a water/sediment slurry that can then be transferred to the tanker.

Without regular maintenance, the system quickly reaches capacity. Oil and solid pollutants are re-entrained into the flow, rendering the device ineffective. Regular inspections should be made to assess sediment and oil levels along with outflow oil concentrations.

*See also*: Baffled pits, Sediment traps.

### *References and further information*

- Auckland Regional Council, 1992, *Design Guideline Manual: Stormwater Treatment Devices*.
- Camp Dresser and McKee, 1993, *California Storm Water Best Management Practice Handbooks: Municipal*.
- Galli, J, 1992, *Current Assessment of Urban Best Management Practices, Analysis of Urban BMP Longevity in Prince George County*.
- Horner, R.R., Skupien, J.J., Livingston, E.H. and Shaver, H.E., 1994, *Fundamentals of Urban Runoff Management*.
- Maryland Department of Environment, 1991, *Water Quality Inlets (Oil/Grit Separators)*.
- Ontario Ministry of Environment and Energy, 1994, *Stormwater Management Practices Planning and Design Manual*.
- Schueler, T.R., 1987, *Controlling Urban Runoff: A Practical Manual for Planning and Designing Urban BMPs*.
- Schueler, T.R., Kumble, P.A. and Heraty, M.A., 1992, *A Current Assessment of Urban Best Management Practices: Techniques for Reducing Non-Point Source Pollution in the Coastal Zone*.
- Whelans, Halpern Glick Maunsell, Thompson Palmer and Murdoch University, 1994, *Planning and Management Guidelines for Water Sensitive Urban (Residential) Design*.

## Secondary treatment Type 4: Porous pavements

### Description

Porous pavements are suitable for areas with light traffic loads such as car parks. They allow run-off to infiltrate through the pavement's surface to the underlying soil, rather than simply running off the pavement.

There are two broad groups of porous pavements. The first uses deep, open-graded asphalt/concrete pavements with a large proportion of the normal fine aggregate material excluded. The second uses modular paving, which presents large 'gaps' between impervious paved areas for infiltration.

These pavements may be located above a deep gravel layer or reservoir, which in turn, is bedded on a sand filter layer. Run-off percolates through the porous pavement into the gravel reservoir and into the sand filter below.

Removal of particulate and some dissolved pollutants is achieved by filtration and adsorption on to soil particles. Moderate soil infiltration rates are required—low rates will result in long infiltration periods, while high rates may cause groundwater pollution.

### Advantages

- retains pollutants close to source;
- reduces site run-off, attenuates flood peaks and increases groundwater flow rates; and
- can be aesthetically more pleasant than conventional drainage channels.

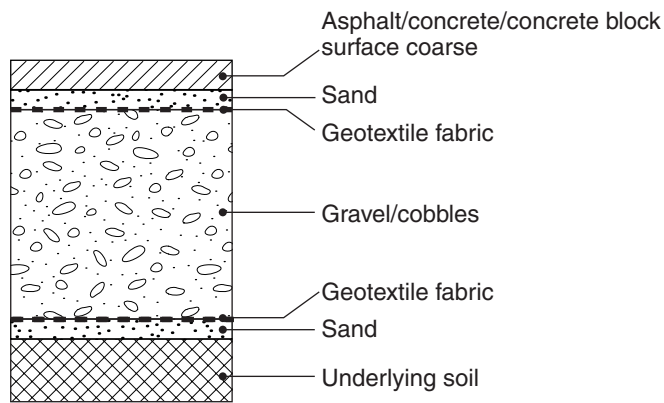
### Limitations

- can only support light traffic loads;
- pavement clogging can reduce effectiveness;
- possible risk of groundwater contamination; and
- only suitable for mildly sloped sites.

Estimated treatment performance summary					
gross pollutants	L	coarse sediment	H	medium sediments	M/H
fine sediments	M	attached pollutants	M	dissolved	L
installation costs	M	maintenance costs	L/M	head requirements	L
N = negligible, L = low, M = moderate, H = high, VH = very high					

### Trapping performance

Porous pavements applications have high reported failure rates (Schueler et al. 1992; Galli 1992). This is due to sediment clogging of the pavement surface. Pre-treatment for sediment removal is not possible for urban pavement run-off, although overland flow could be pre-treated with grass filter strips.



**Figure 7.26 Porous pavements.**

### *Cost considerations*

Capital and maintenance costs of porous pavement systems are both moderate to high.

### *Design considerations*

Porous pavement site selection and design techniques may be based on those used for infiltration trenches (refer Secondary treatment Type 4: Infiltration trenches). This includes development of the geometry of the rock reservoir.

The factors that will maximise the likely success of a porous pavement include:

- low traffic volumes and light vehicle weights;
- low sediment loads;
- at least moderate soil infiltration rates; and
- regular and appropriate maintenance of the pavement's surface.

Additional considerations include the need for the sub-soil to be able to support saturated load conditions. Other sizing techniques are described in Schueler (1987) and Maryland Department of the Environment (1984).

### *Maintenance*

Regular pavement surface maintenance is essential for porous pavements. Inadequate maintenance has been a cause of the high failure rate for these devices.

Collected pollutants need to be regularly removed from the aggregate to ensure optimal infiltration. Methods for removing collected pollutants include high suction vacuum sweepers or high pressure jet hoses. The pavement should also be inspected for holes, cracks or excessively blocked areas.

*See also:* Filter strips, Infiltration trenches.

### *References and further information*

- Construction Industry Research and Industry Information Association (CIRIA), 1992, Report 123, *Scope for Control of Urban Runoff, Volume 1*, CIRIA Report 124, *Scope for Control of Urban Runoff, Volumes 2, 3 and 4*.
- Galli, J., 1992, *Current Assessment of Urban Best Management Practices, Analysis of Urban BMP Longevity in Prince George County*.
- Maryland Department of the Environment, 1984, *Standards and Specifications for Infiltration Practices*.
- Ontario Ministry of Environment and Energy, 1994, *Stormwater Management Practices Planning and Design Manual*.
- Schueler, T.R., 1987, *Controlling Urban Runoff: A Practical Manual for Planning and Designing Urban BMPs*.
- Schueler, T.R., Kumble, P.A. and Heraty, M.A., 1992, *A Current Assessment of Urban Best Management Practices: Techniques for Reducing Non-Point Source Pollution in the Coastal Zone*.
- Whelans, Halpern Glick Maunsell, Thompson Palmer and Murdoch University, 1994, *Planning and Management Guidelines for Water Sensitive Urban (Residential) Design*.

## **Secondary treatment Type 5: Infiltration trenches**

### *Description*

An infiltration trench is a shallow, excavated trench filled with gravel or rock, into which run-off drains. Stormwater exfiltrates from the trench into the surrounding soil, while particulates and some dissolved pollutants are retained in the trench.

The trench is lined with a layer of geotextile fabric, to prevent soil migration into the rock or gravel fill. The top surface of the fill is also covered with a layer of fibre fabric, then finished with a shallow layer of topsoil.

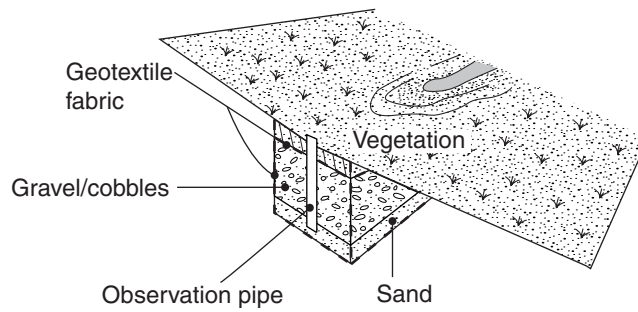
Local soil geochemistry and grading determine the infiltration trench's ability to remove particulate and dissolved pollutants. The trenches increase the soil moisture levels, groundwater flow rates and reduce stormwater flow velocities.

### *Advantages*

- reduces peak run-off rates and volumes, and recharges groundwater; and
- retains pollutants prior to discharge into the drainage or groundwater system.

### *Limitations*

- pollutants and sediment may clog the gravel and infiltration surface;
- groundwater contamination and low dissolved pollutant removal may occur in coarse soils; and
- cannot be located on steep slopes, loose or unstable areas.



**Figure 7.27 Infiltration trench.**

<b>Estimated treatment performance summary</b>					
gross pollutants	L	coarse sediment	M/H	medium sediments	M
fine sediments	L/M	attached pollutants	L/M	dissolved	L
installation costs	L	maintenance costs	M/H	head requirements	L
N = negligible, L= low, M = moderate, H = high, VH = very high					

#### *Trapping performance*

More data are required to assess the pollutant retention capabilities of infiltration trenches.

#### *Cost considerations*

Capital costs associated with infiltration trenches are low, but maintenance costs can be moderate to high, particularly in fine soil areas.

#### *Design considerations*

Infiltration trenches are highly susceptible to blockage problems. They are only suitable for use in areas where sediment yields are controlled, such as established urban areas.

A grass buffer or filter is often located upstream of the trench to remove coarse particulate matter. An overflow berm may be located on the downstream side of the trench to encourage ponding of water over the trench to increase infiltration.

Key design issues are the treatment flow rate, surrounding soil infiltration rates, porous media type and size and the potential for clogging. More design information is presented in Appendix D.

#### *Maintenance*

To avoid clogging of the porous media, regular maintenance of infiltration trenches is crucial. Clogged media are cleaned by removing and washing the material and replacing the top fibre fabric layer.

Periodic inspections to detect early signs of clogging are also required. Surface ponding, water remaining in the trench for extended periods or sediment accumulation in the top layer are all early warnings of porous media clogging.

See also: Filter strips, Grass swales, Sand filters, Infiltration basins.

### **References and further information**

- Auckland Regional Council, 1992, *Design Guideline Manual: Stormwater Treatment Devices*.
- Construction Industry Research and Industry Information Association, 1992, Report 123, *Scope for Control of Urban Runoff, Volume 1*, CIRIA Report 124, *Scope for Control of Urban Runoff, Volumes 2, 3, and 4*.
- Galli, J., 1992, *Current Assessment of Urban Best Management Practices, Analysis of Urban BMP Longevity in Prince George County*.
- Maryland Department of the Environment, 1984, *Standards and Specifications for Infiltration Practices*.
- Ontario Ministry of Environment and Energy, 1994, *Stormwater Management Practices Planning and Design Manual*.
- Schueler, T.R., 1987, *Controlling Urban Runoff: A Practical Manual for Planning and Designing Urban BMPs*.
- Schueler, T.R., Kumble, P.A. and Heraty, M.A., 1992, *A Current Assessment of Urban Best Management Practices: Techniques for Reducing Non-Point Source Pollution in the Coastal Zone*.
- Whelans, Halpern Glick Maunsell, Thompson Palmer and Murdoch University, 1994, *Planning and Management Guidelines for Water Sensitive Urban (Residential) Design*.

## **Secondary treatment Type 6: Infiltration basins**

### **Description**

Stormwater infiltration basins are open excavated basins designed to retain storm flows, infiltrating run-off through the floor of the basin. They rely on suitable soil conditions for effective operation. Infiltration basins remove sediment and some dissolved soluble pollutants from stormwater run-off. Pollutant removal occurs principally through filtration and the adsorption of soluble pollutants on to soil particles.

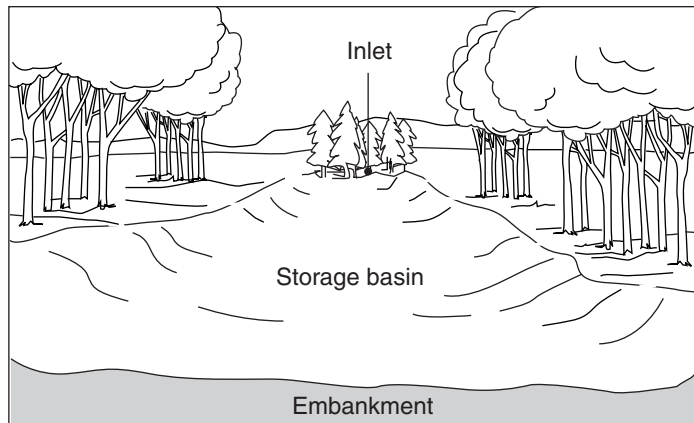
They are intended to overflow during large storms. Unlike infiltration trenches, infiltration basins do not include a gravel or rock fill. If properly designed and maintained, infiltration basins reduce downstream run-off volumes and velocities.

### **Advantages**

- removes particulates and some dissolved pollutants; and
- reduces peak run-off rates and volumes, and recharges groundwater.

### **Limitations**

- only suitable in areas with specific soil types;
- sediment may clog the infiltration surface-pre-treatment may be required;
- groundwater contamination and low dissolved pollutant removal may occur in coarse soils;



**Figure 7.28 Infiltration basins.**

- cannot be located on steep slopes, loose or unstable areas;
- maintenance activities such as mowing can compact the surface and clog the infiltration system; and
- large land areas may be required.

<b>Estimated treatment performance summary</b>					
gross pollutants	N	coarse sediment	M/H	medium sediments	M
fine sediments	M	attached pollutants	M	dissolved	L
installation costs	L/M	maintenance costs	H	head requirements	L
N = negligible, L = low, M = moderate, H = high, VH = very high					

### *Trapping performance*

A high failure rate for infiltration basins has been reported in north-eastern United States (Galli 1992). This has been primarily due to surface clogging and inappropriate design. Pre-treatment to remove coarse sediment, such as sediment traps, may be appropriate to minimise the probability of clogging.

Clogged infiltration basins are difficult to restore, but may be converted to other measures such as detention basins or constructed wetlands.

Large flows to infiltration basins may only be accommodated in areas with very high permeability soils. The potential for groundwater pollution should be considered under these circumstances.

### *Cost considerations*

Infiltration basin capital costs range from low to moderate, depending on land acquisition requirements. Maintenance costs can be high. Inadequate maintenance has been a cause of the high failure rate for these basins.



### *Design considerations*

Site selection criteria for the infiltration basin are similar to those used for infiltration trenches (refer Secondary treatment Type 6: Infiltration trenches). Typically, soil hydraulic loading rate and conductivity are key design factors.

### *Maintenance*

Maintenance of infiltration basins is essential for beneficial operation. Maintenance activities include removal of deposited sediment and tilling of the basin bed to improve infiltration. In addition, regular inspections are required to monitor: the duration of ponding in the basin; the basin floor to check for signs of erosion, sediment deposition and grass growth; and the spillway's structural stability.

*See also:* Infiltration trenches, Detention basins.

### *References and further information*

Auckland Regional Council, 1992, *Design Guideline Manual: Stormwater Treatment Devices*.

Camp Dresser and McKee, 1993, *California Storm Water Best Management Practice Handbooks: Municipal*.

Galli, J., 1992, *Current Assessment of Urban Best Management Practices, Analysis of Urban BMP Longevity in Prince George County*.

Maryland Department of the Environment, 1984, *Standards and Specifications for Infiltration Practices*.

Ontario Ministry of Environment and Energy, 1994, *Stormwater Management Practices Planning and Design Manual*.

Schueler, T.R., 1987, *Controlling Urban Runoff: A Practical Manual for Planning and Designing Urban BMPs*.

Schueler, T.R., Kumble, P.A. and Heraty, M.A., 1992, *A Current Assessment of Urban Best Management Practices: Techniques for Reducing Non-Point Source Pollution in the Coastal Zone*.

Whelans, Halpern Glick Maunsell, Thompson Palmer and Murdoch University, 1994, *Planning and Management Guidelines for Water Sensitive Urban (Residential) Design*.

## **Secondary treatment Type 7: Extended detention basins**

### *Description*

Extended detention basins store run-off for periods of one to two days, then drain between storm events. There are many different basin designs; all incorporate a water retention barrier or embankment and a water outlet structure. The water outlet provides a controlled discharge of collected water in the basin.

Pollutant removal is achieved through sedimentation. The pollutant removal efficiency of these basins depends on the stormwater residence time and the amount of run-off



**Figure 7.29 Extended detention basin.**

detained in the basin. The longer the residence time and the more water stored by the basin, the better the performance.

*Advantages*

- appropriate in areas where conditions are not suitable for constructed wetlands;
- offers potential for multiple use, if the basin drains between storm events (e.g. sports field or park); and
- detains flows and attenuates downstream flood peaks.

*Limitations*

- provides only limited removal of fine sediment or dissolved pollutants;
- efficiency falls for events smaller than the design event;
- outlet structures are prone to clogging;
- potential for erosion and resuspension of deposited sediment; and
- large land areas may be required.

<b>Estimated treatment performance summary</b>					
gross pollutants	L	coarse sediment	M/H	medium sediments	M
fine sediments	L/M	attached pollutants	L/M	dissolved	L
installation costs	L/M	maintenance costs	M/H	head requirements	L
N = negligible, L= low, M = moderate, H = high, VH = very high					

### *Trapping performance*

Due to the absence of a permanent pool in the floor of the basin, resuspension of sediment can occur during storm events. Overall, the pollutant retention provided by an extended detention basin is lower and less reliable than that offered by a constructed wetland.

There are currently no techniques available for predicting the pollutant retention of extended detention basins. Optimal reported performance occurs for a retention time of 24 to 40 hours. Stahre and Urbonas (1990) quote the following pollutant retention rates for a 40 hour retention:

<b>Pollutant</b>	<b>Retention (%)</b>	<b>Pollutant</b>	<b>Retention (%)</b>
Suspended solids	50 to 70	Total phosphorus	10 to 20
Oil and grease	50 to 70	Total nitrogen	10 to 20
Lead	75 to 90	Bacteria	50 to 90
Zinc	30 to 60	Chemical oxygen demand	20 to 40

**Table 7.5 Pollutant retention rates for extended detention basins (40 hour retention). Source: Stahre and Urbonas 1990.**

### *Cost considerations*

Capital costs are low to moderate, although maintenance costs are moderate to high.

### *Design considerations*

Basin design should aim to maximise the retention time for as broad a range of storm sizes as possible while providing a safe environment for the public to enjoy. The outlet control is an important consideration, as is the hydrology of the catchment, while consideration of side slopes, fencing and controlling pests is also important.

Two common operational problems occur with basin outlets. Firstly, the outlet may be too large, resulting in only partial filling of the basin and reduced residence times. Secondly, the outlet may become blocked by debris, extending the detention time and resulting in boggy conditions on the floor of the basin.

There are three types of outlets commonly used: weirs, perforated risers and reverse slope pipes.

The flow attenuation features of extended detention basins can be used to advantage during relatively infrequent hydrological events. By incorporating a two-stage outlet, the basin may be designed to accommodate design storm run-off for an extended period, and a flood mitigation storm (e.g. 100 year ARI) for a short period. In addition to flood control, detention also results in some removal of coarse sediment. More detailed design information is presented in Appendix E.

For selected extended detention basins there is also a potential to transform the system into a constructed wetland system (described in Section 7.9) without large capital investment. This can provide additional water quality improvement as well as providing for flood detention and improved wildlife habitat.

### *Maintenance*

Maintenance is essential for the satisfactory operation of a detention basin. The outlet structure must be routinely inspected and kept free from debris. This is particularly important after storm events. Regular inspection will also indicate when clearing of the accumulated basin sediment is required.

*See also:* Sediment settling basins.

### *References and further information*

Auckland Regional Council, 1992, *Design Guideline Manual: Stormwater Treatment Devices*.

Camp Dresser and McKee, 1993, *California Storm Water Best Management Practice Handbooks: Municipal*.

Horner, R.R., Skupien, J.J., Livingston, E.H. and Shaver, H.E., 1994, *Fundamentals of Urban Runoff Management*.

Maryland Department of the Environment, 1987, *Design Procedures for Stormwater Management Extended Detention Structures*.

Ontario Ministry of Environment and Energy, 1994, *Stormwater Management Practices Planning and Design Manual*.

Schueler, T.R. and Helfrich, N., 1989, 'Design of extended detention wet pond systems'.

Schueler, T.R., Kumble, P.A. and Heraty, M.A., 1992, *A Current Assessment of Urban Best Management Practices: Techniques for Reducing Non-Point Source Pollution in the Coastal Zone*.

Stahre P. and Urbonas B., 1990, *Stormwater Detention for Drainage, Water Quality and CSO Management*.

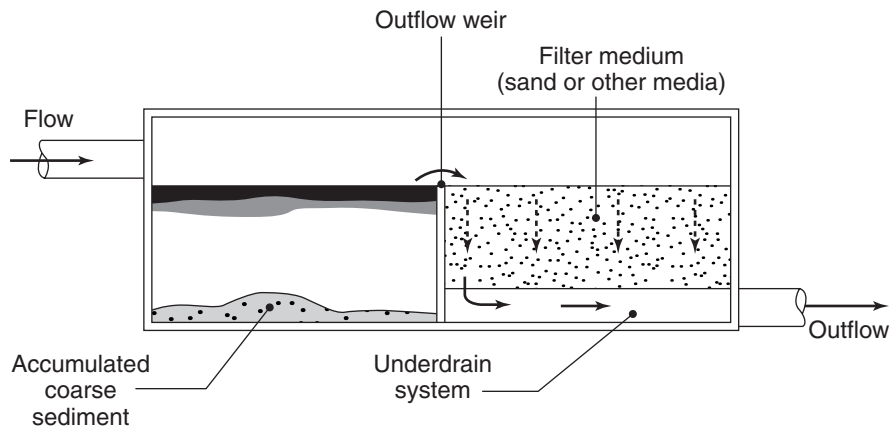
Whelans, Halpern Glick Maunsell, Thompson Palmer and Murdoch University, 1994, *Planning and Management Guidelines for Water Sensitive Urban (Residential) Design*.

## **Secondary treatment Type 8: Sand filters**

### *Description*

Sand filters comprise a bed of sand or other media through which run-off is passed. The filtered run-off is then collected by an underdrain system.

Sand filters are often constructed within a formal tank. Although sand is most commonly used as the filter media, peat, limestone and topsoil have also been used. The filters are provided with an upstream pre-treatment system to remove coarse sediment and ensure even inflow distribution across the filter.



**Figure 7.30 Sand filters.**

Sand filter pre-treatment system is generally intended to trap sand and gravel, while the filter itself removes finer silt and clay particles. These pre-treatments can incorporate top-soil and grass cover and can treat flow from floodways or piped systems.

There are two basic scales of sand filters: large (up to 25–50 hectares) and small (less than 2 hectares). Small sand filters are located in underground pits or chambers and are generally best suited to highly impervious catchments.

*Advantages*

- can be retrofitted into existing systems (including underground installations);
- retains coarse and fine sediments; and
- appropriate in areas where condition are not suitable for constructed wetland.

*Limitations*

- requires upstream litter and coarse sediment removal to minimise clogging;
- easily clogged—the filter’s effectiveness is highly dependent on maintenance frequency;
- high head loss and relatively low flow rates through the filter;
- large sand filters without grass cover may be unattractive; and
- not suitable for disturbed catchments or catchments with high sediment yields.

<b>Estimated treatment performance summary</b>					
gross pollutants	L	coarse sediment	M/H	medium sediments	M/H
fine sediments	M	attached pollutants	M	dissolved	L
installation costs	M/H	maintenance costs	M/H	head requirements	H
N = negligible, L= low, M = moderate, H = high, VH = very high					

### *Trapping performance*

The actual performance of a sand filter will depend on the characteristics of the inflow sediments. This can relate to catchment geology and soil type—for example, a clay soil catchment area may require a larger sized filter. The influence of soil type can be expected to decrease with catchment impervious fraction (Auckland Regional Council 1992).

More performance data are required to assess sand filter performance in Australian conditions.

### *Cost considerations*

Sand filter capital and maintenance costs are both moderate to high.

### *Design considerations*

Sand filter design and sizing techniques are presented in Appendix F.

### *Maintenance*

Sand filter maintenance involves routine removal of the collected sediments. Drying of the sediment may be required prior to disposal. In addition, the filter surface should be raked regularly to remove sediment and to break up any crusts. When necessary, the top 50 to 100 millimetre layer of the filter media should be removed and replaced.

If the filter is not cleaned frequently, the entire filter media may need to be replaced due to migration of sands within the media. Frequent maintenance can prove more cost-effective in the long term.

To determine the required cleaning frequency, regular filter inspections are necessary to check for signs of blockage. These can include ponding, surface clogging and increased depth of sedimentation in the settling tank.

*See also:* Infiltration trenches.

### *References and further information*

Auckland Regional Council, 1992, *Design Guideline Manual: Stormwater Treatment Devices*.

Camp Dresser and McKee, 1993, *California Storm Water Best Management Practice Handbooks: Municipal*.

Galli, J., 1992, *Current Assessment of Urban Best Management Practices, Analysis of Urban BMP Longevity in Prince George County*.

Horner, R.R., Skupien, J.J., Livingston, E.H. and Shaver, H.E., 1994, *Fundamentals of Urban Runoff Management*.

Ontario Ministry of Environment and Energy, 1994, *Stormwater Management Practices Planning and Design Manual*.

- Schueler, T.R., 1987, *Controlling Urban Runoff: A Practical Manual for Planning and Designing Urban BMPs.*
- Schueler, T.R., Kumble, P.A. and Heraty, M.A., 1992, *A Current Assessment of Urban Best Management Practices: Techniques for Reducing Non-Point Source Pollution in the Coastal Zone.*
- Shaver, E., 1996, *Sand Filter Design for Stormwater Treatment.*
- Truong, H.V. and Phua, M.S., 1995, *Application of the Washington DC Sand Filter for Urban Runoff Control.*

## 7.9 Tertiary treatment: index

---

<b>Tertiary treatment type</b>	<b>Page no.</b>
<b>Constructed wetland systems</b>	
Description	194
Advantages	198
Limitations	198
Cost considerations	199
Maintenance	199
<b>Design of wetland systems</b>	
Wetland design consideration No. 1: Location	202
Wetland design consideration No. 2: Sizing	203
Wetland design consideration No. 3: Pre-treatments	206
Wetland design consideration No. 4: Morphology	207
Wetland design consideration No. 5: Outlet structures	207
Wetland design consideration No. 6: Macrophyte planting	210
Wetland design consideration No. 7: Maintenance	214
Wetland design consideration No. 8: Loading of organic material	214
Wetland design consideration No. 9: Safety issues	214
Wetland design consideration No. 10: Multiple uses	214
Wetland design consideration No. 11: Groundwater considerations	215
Wetland design consideration No. 12: Mosquito control	215
<b>Key references</b>	
NSW Department of Land and Water Conservation, 1998, <i>The Constructed Wetlands Manual</i> .	
Wong, T.H.F., Breen, P.F., Somes, N.L.G. and Lloyd, S.D., 1998, <i>Managing Urban Stormwater using Constructed Wetlands</i> .	
Wong, T.H.F., Breen, P.F., Lawrence, I., Somes, N.L.G. and Lloyd, S.D., 1999, 'Design guidelines for constructed wetland systems'.	





**Figure 7.31** A typical constructed wetland in Melbourne.

### 7.9.1 **Constructed wetland systems**

---

#### *Description*

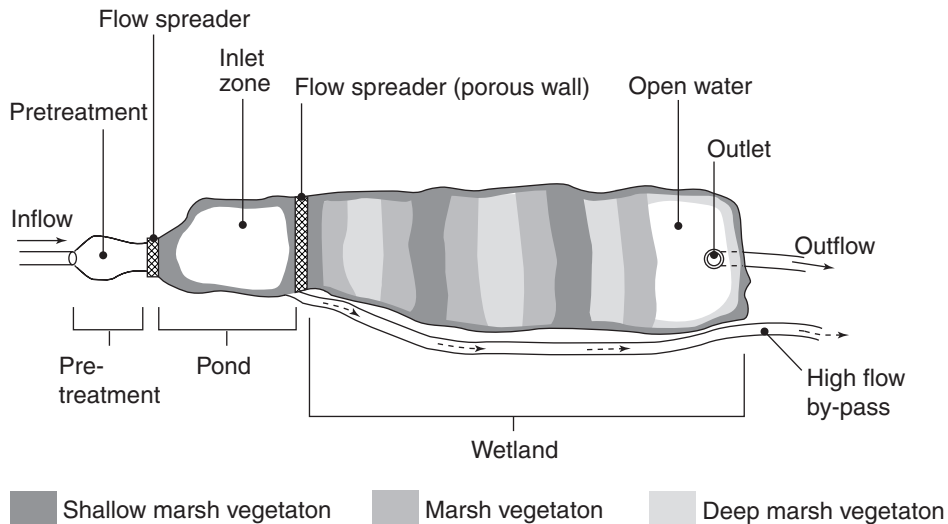
A constructed wetland system generally comprises two principal components:

- *the pond*: a relatively deep open water body with edge and possibly submergent macrophytes (aquatic plants).
- *the wetland*: or macrophyte zone; a permanent or ephemeral shallow water body with extensive emergent vegetation. Specific zones of vegetation will occur throughout the wetland; each zone's vegetation is generally determined by the area's water depth and frequency and duration of inundation.

The pond is generally located upstream of the wetland, with the system often incorporating primary pre-treatments at the inlet to provide coarse sediment and gross pollutant removal. The relative ordering and sizing of the pond/wetland components within the constructed wetland system may vary to suit local conditions.

Constructed wetland systems are generally built on catchments larger than ten hectares. Three key pollutant retention processes occur in constructed wetland systems:

- sedimentation;
- fine particle filtration; and
- nutrient uptake by sediments, biofilms (layers of bacteria and micro-organisms on submerged plant and other surfaces) and macrophytes.



**Figure 7.32 Schematic representation of a constructed wetland system.**

The constructed wetland systems is illustrated schematically in Figure 7.32.

Although the pond and wetland areas contribute uniquely to the system’s overall pollutant treatment and removal process, both share two common functions:

- provision of vegetated zones that help prevent oxygen depletion and subsequent release of phosphorous from sediments; and
- provision of open water areas for ultra violet (UV) exposure, which encourages bacteria die-off.

The specific functions unique to the pond and wetland areas are described in Table 7.6

<b>Pond functions</b>	<b>Wetland functions</b>
<ul style="list-style-type: none"> <li>▪ Traps ‘readily settleable’ solids: pond areas generally trap solids down to coarse and medium silt size range. Sedimentation is further enhanced by the edge macrophytes.</li> <li>▪ Traps adsorbed pollutants: silt particles trapped in the pond system may also retain adsorbed pollutants.</li> <li>▪ Provides hydrologic and hydraulic management: pond areas buffer and distribute water movements within the wetland system.</li> <li>▪ Provides sediment aeration: edge macrophytes aerate sediments.</li> </ul>	<ul style="list-style-type: none"> <li>▪ Traps dissolved pollutants: this is primarily achieved by adsorption and biofilm growth on macrophytes.</li> <li>▪ Traps fine suspended solids by enhanced sedimentation within the wetlands densely vegetated, shallow waters.</li> <li>▪ Transforms organic components: reduces the biological availability of organic material.</li> <li>▪ Encourages biofilm growth: vegetation and other surfaces provide a substrate for biofilm growth which enhances fine sediment retention.</li> <li>▪ Provides plant litter zones: wetlands provide an area for macrophyte plant litter to accumulate.</li> </ul>

**Table 7.6 Principal pollutant removal functions of pond and wetland systems.**

The proportion of pond to wetland in a constructed wetland system will vary depending on the nature of the inflows, particularly the suspended sediment sizes.



**Figure 7.33** Inlet zone providing coarse sediment capture, Ruffeys Creek, Doncaster.



**Figure 7.34** Looking downstream into the shallow marsh zone from the porous rock flow spreader, Ruffeys Creek, Doncaster.



**Figure 7.35 Wetland in Ruffeys Creek, Doncaster, showing open water and deep marsh zones.**



**Figure 7.36 Lake downstream of Ruffeys Creek wetland system.**

For systems principally treating coarse material, the pond will provide the main treatment area. Under these conditions, the role of the wetland area is primarily to remove the dissolved or finely dispersed pollutants released from the pond sediments.

Conversely, constructed wetland systems treating largely dissolved or finely dispersed pollutants will achieve most pollutant retention within the wetland area. In these

situations, the pond acts as a pre-treatment system, removing coarse sediment that may damage the wetland vegetation.

Wetland vegetation is critical to the performance of a constructed wetland system. The functions performed by wetland vegetation vary according to flow conditions. Table 7.7 compares the functions of vegetation under baseflow and storm event flow conditions.

<b>Vegetation Functions</b>	
<b>Baseflow conditions</b>	<b>Storm event flow</b>
<ul style="list-style-type: none"> <li>▪ Nutrient conversion: wetland vegetation acts as substrata for epiphytes.<sup>†</sup> Epiphytes convert soluble nutrients into particulate organic material, which can settle out and enter the sediments. This is a short term process occurring over days to weeks.</li> <li>▪ Nutrient consolidation: nutrients trapped in the sediments are progressively taken up into the macrophyte biomass. This is a medium term process occurring over months to years.</li> <li>▪ Organic sediment and peat development: macrophyte debris provides a source of particulate biomass, which is returned to the wetland sediment. This is a long term process occurring over years to decades, resulting in the development of organic sediment and peats.</li> </ul>	<ul style="list-style-type: none"> <li>▪ Promotes even distribution of fbws: vegetation spreads the flow across a wide surface area.</li> <li>▪ Promotes sedimentation of larger particles: by decreasing flow velocities through even flow distribution.</li> <li>▪ Improves retention of smaller particles: plant surfaces provide a greater area for adhesion of smaller particles.</li> <li>▪ Protects sediments and banks from erosion: plants and their root systems hold sediments together and prevent scour.</li> <li>▪ Increases the system hydraulic roughness: helps attenuate destructive storm flows.</li> </ul>
<p><sup>†</sup> Epiphyte: A plant that grows on another plant, not in a parasitic way, but using it merely as a supporting base.                      Source: Somes, Breen and Wong 1995.</p>	

**Table 7.7 Treatment functions of vegetation in a constructed wetland system.**

*Advantages*

- can potentially achieve high sediment and nutrient retention efficiencies;
- can be incorporated into the urban landscape, providing improved habitat, recreational and visual amenity;
- can include a flood storage to attenuate downstream flows;
- can potentially be retrofitted into existing flood retarding basins; and
- can be designed as either a permanently wet or ephemeral system.

*Limitations*

- either pre-treatment or removal mechanisms are required at the inlet to remove coarse sediment and litter;
- large land areas are required for construction;
- where either treatment or other multiple use objecties require permanently wet areas or open water, reliable inflow is needed;
- treatment performance is highly sensitive to hydrologic and hydraulic design;

- can take up to three years to achieve optimal performance;
- potential impact on public health and safety; and
- may contribute to groundwater pollution, or groundwater may impact on the wetland.

Estimated treatment performance summary					
gross pollutants	L/M	coarse sediment	M/H	medium sediments	M/H
fine sediments	L/M	attached pollutants	M/H	dissolved	L/M
installation costs	H	maintenance costs	M	head requirements	L/M
N = negligible, L= low, M = moderate, H = high, VH = very high					

*Cost considerations*

Constructed wetlands require relatively large areas of land, so construction costs are high in built-up areas. The cost of vegetation establishment is also high, although maintenance cost are moderate.

*Maintenance*

An operation and maintenance plan should be prepared for all constructed wetlands. This plan should address the wetland’s entire ‘life cycle’ and can include:

- **construction and commissioning:** proper environmental management during the wetland construction and commissioning period;
- **sediment and litter removal:** removal of sediment and litter from the inlet zone or primary pre-treatment will be required on a regular basis. Litter should not be allowed to accumulate excessively after a storm, otherwise breakdown products may pollute the water;
- **weed maintenance:** this is particularly critical during construction and commissioning; and
- **de-commissioning:** a major refit or decommissioning will be required when the wetland reaches its design life.

The frequency of maintenance may be reduced by incorporating pre-treatment upstream of the wetlands system to remove coarse sediment and litter. If a pre-treatment measure is not included in the wetland system design, wetland sediment removal is expected to be required every three to six months, which results in unacceptable disturbance. This falls to a frequency of between ten to thirty years in systems that incorporate sediment removal as a pre-treatment, which all new wetland systems should do.

The ability to draw down the wetland inlet zone during sediment removal should also be considered during the design phase.

To minimise maintenance costs, the wetland can also be designed for mechanised sediment removal—possibly by incorporating submerged berms.

Macrophyte harvesting is not considered necessary to maintain the long term nutrient retention capacity of the constructed wetland system. However, occasional harvesting may be desirable to maintain a vigorous vegetation cover.

Inspections should be carried out as part of an overall system maintenance program. Along with providing a general monitor of the health and diversity of the vegetation, inspections provide the opportunity to detect specific site problems. These can include the accumulation of sediment, plant debris, litter or oils; infestation of weeds; mosquito and other pest problems; algal blooms; and scouring. Inspections will also help assess the wetland systems' performance in achieving its stated objectives.

Many weed species are transported during flood events. As a result, inspection should occur after each major event. This also provides the opportunity to locate any physical damage caused by high flows.

### 7.9.2 Design of wetland systems

---

Constructed wetland systems satisfy many urban design objectives in addition to improving stormwater quality. For example, they provide passive recreational and landscape values, wildlife habitat and flood control. Early identification of multiple use priorities is critical for the design of effective wetlands systems. The design process is often a balance between effective stormwater pollution abatement and landscape, botanical and habitat functions.

These guidelines focus on the pollution abatement functions of constructed wetland systems. This is an evolving field and there is little other guidance available. However, it is recognised that constructed wetland systems require multi-disciplined design teams to address the range of objectives for each proposed wetland system. More general discussion of the multi-purposes of wetland systems can be found in NSW Department of Land and Water Conservation (1998).

The treatment capability of a wetland system depends on how much run-off is treated (i.e. the size of the wetland) and the level of pollutant removal afforded to the treated run-off (a function of the vegetation and basin layout). The volume of run-off a wetland system treats is termed its 'hydrologic effectiveness' and is a function of the detention time, the volume of the wetland system and the characteristics of the rainfall and run-off. The hydrologic effectiveness is maximised (i.e. the most water is treated) when either the storage volume is increased or the detention time reduced.

Design objectives for an efficient wetland system for stormwater pollutant removal include:

- **establishment of uniform flow:** ensure uniform flow distribution through the wetland. In particular, minimise flow 'short-circuiting' and stagnant areas in the wetland;

- **maximisation of macrophyte contact time:** to enhance sedimentation, maximise the contact time with macrophytes by encouraging healthy vegetation and low flow velocities;
- **establishment of adequate wetland pre-treatment:** ensure coarse sediment and litter is removed upstream of the wetland;
- **minimisation of organic loading:** minimise loading of organic matter to ponds and open water areas; and
- **factoring in of maintenance:** provide for operations and maintenance needs, particularly sediment removal and weed management.

To meet these objectives, twelve primary areas of design must be addressed. These areas are reviewed in the following sections:

- 1 Location
- 2 Sizing
- 3 Pre-treatments
- 4 Morphology
- 5 Outlet structures
- 6 Macrophyte planting
- 7 Maintenance
- 8 Loading of organic matter
- 9 Safety issues
- 10 Multiple uses
- 11 Groundwater considerations
- 12 Mosquito control

After a site has been selected, more detailed design issues may be considered. These will address more site specific issues and include the consideration of:

- catchment area and the distribution of soils within the catchment;
- site soil characteristics;
- catchment infiltration capacity;
- pollutant sources and pollutant loads;
- the nature of pollutants entering the catchment;



- catchment hydrology; including peak flows, volumes, flow variability and seasonality; and
- water quality and other wetland objectives.

### **Wetland system design consideration No. 1: Location**

There are many considerations when deciding where to position a wetland system that reflect the multi-objectives of the system. Factors include the surrounding land-uses, available space, aesthetic values, wildlife considerations and the best location for improving stormwater quality. Issues described here relate directly to the stormwater treatment objectives of the system. These issues would then need to be weighed up against other objectives for the wetland system.

In locating a wetland system it is essential that the wetland be protected from large flood flows. These can scour sediments and destroy vegetation. Provision of a high flow bypass channel is a means of reducing this risk, while still treating all flows up to a threshold.

Three potential ways of providing a high flow bypass are shown in Figure 7.37. The selection of a particular system may be based on an economic comparison, which will be partially dependent on flow rates and topography.

The first way (option (a)) provides a high flow by-pass around a wetland system located on the natural drainage path.

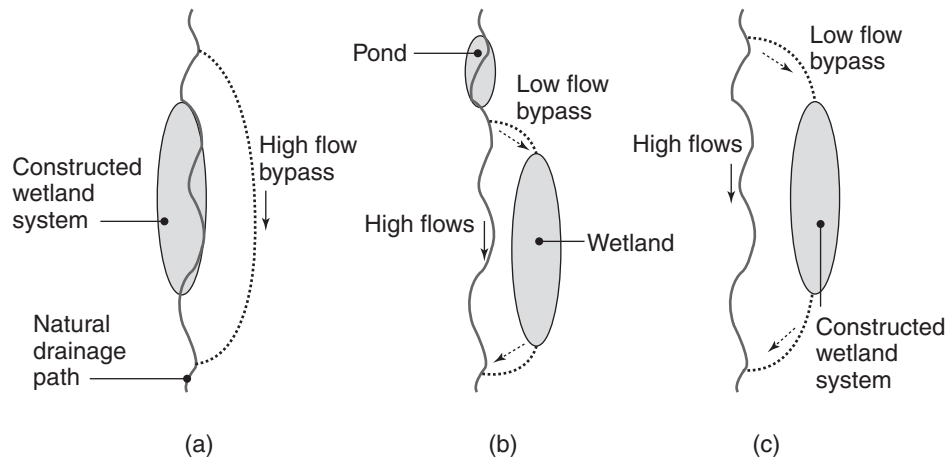
The second way (option (b)) locates the pond only on the natural drainage path. Downstream of the pond, all but flood flows are directed into a wetland via a low flow by-pass. Flood flows are directed away from the wetland, along the natural drainage path.

The final example (option (c)) diverts all except the flood flows into a wetland system, located on a low flow by-pass away from the natural channel. Once again, flood flows are directed away from the wetland system, along the natural drainage path.

If topographic constraints preclude the provision of a high-flow by-pass, the wetland system can be designed to attenuate inflows. To minimise permanent damage to the macrophytes the velocities throughout the wetland should never exceed *two metres per second* during infrequent storm events (e.g. the 100 year ARI event).

It is generally accepted that the biofilms attached to the macrophytes will be lost under these conditions. The macrophytes will, however, provide a degree of armouring to the sediments, helping to minimise sediment scouring.

Low flow through the wetland can also pose problems. Where annual rainfall is low, there may not be sufficient flows to maintain a permanent water body. In these areas ephemeral wetlands may be more appropriate or supplementary flow may be required during dry periods.



**Figure 7.37 Options for high flow by-passes for wetland systems.**

One potential option for locating wetlands is in existing retarding basins. This can be effected without large capital investment. Such systems can then provide for improved stormwater quality in addition to their flood retention function. However, there are a number of issues that need to be considered for detention basin retrofits. These include: the available space on the floor of the basin, incoming pipe levels and flow rates, existing uses within the basin (including any areas of environmental significance), and impact on flood storage volumes as well as public safety considerations.

### **Wetland system design consideration No. 2: Sizing**

The sizing of constructed wetland systems is affected by a number of factors including:

- the nature of the inflows, particularly their sediment grading, geochemistry, and hydrology;
- the ionic composition of the wetland waters; and
- the geometry and macrophyte planting scheme of the wetland system.

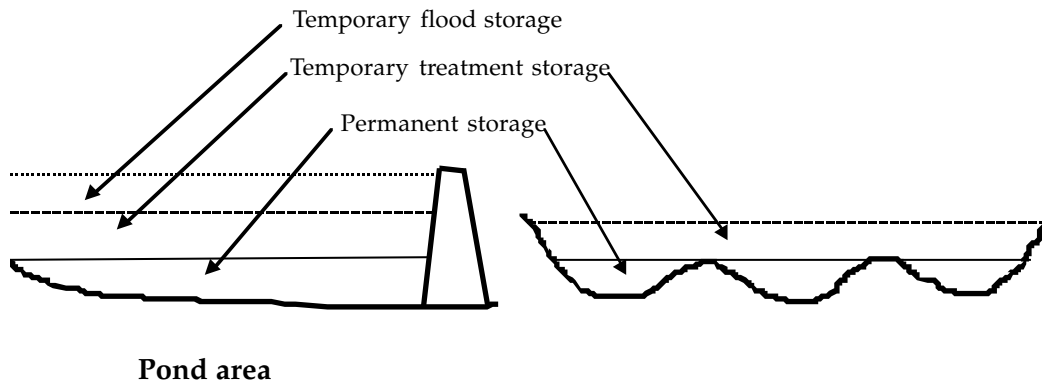
The key elements to be sized in a constructed wetland system are the temporary and permanent storage volumes of the pond and wetland areas, as indicated in Figure 7.38.

If the constructed wetland system is constructed as a single water body, the distribution of these volumes between pond and wetland areas will need to be considered.

The principal purposes and sizing criteria for pond and wetland area storage volumes differ and are described below.

#### *Pond storage volumes*

- **temporary flood storage:** can be used for attenuating peak flows up to the 100 year ARI event. This volume can be sized using a rainfall run-off model to meet flood mitigation criteria;



**Figure 7.38** Definition sketch for wetland system volumes.

- **temporary treatment storage (or extended detention storage):** can be used to enhance the hydraulic residence time of the permanent storage to improve coarse particulate sedimentation. It can also be used to attenuate flows to protect the downstream wetland; and
- **permanent storage:** intended principally for sedimentation. Ideally, the size of this volume will depend on the size and mineralogy characteristics of the inflow particles—particularly their adsorption capacity.

#### *Wetlands storage volumes*

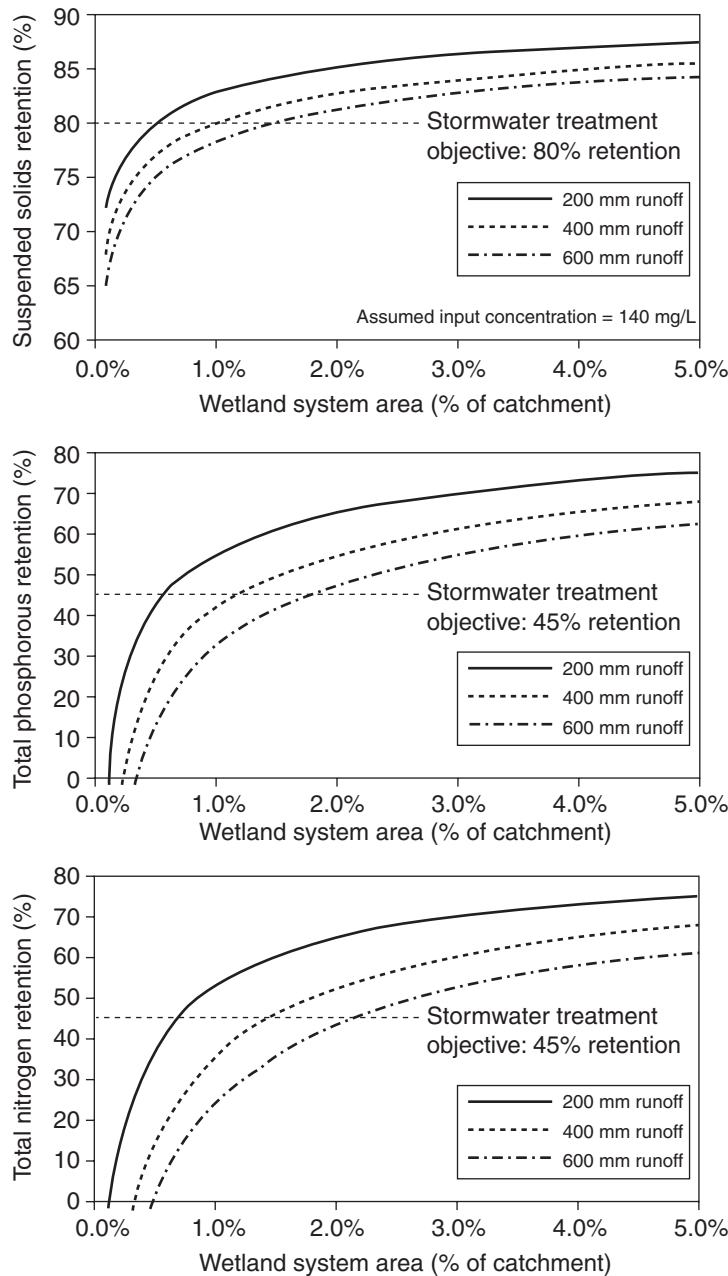
- **temporary storage:** the principal function of this volume is to provide a variable wetting–drying cycle. This encourages a diverse, dense macrophyte growth, which increases the total area available for enhanced sedimentation by the macrophytes; and
- **permanent pool:** an essentially permanent volume, designed to encourage biofilm growth on the macrophytes and the continuation of the sedimentation processes.

To determine the size of temporary and permanent storage volumes of the pond and wetland, detailed design information is required for elements such as the hydrology of the catchment, the target pollutant and the geometry of the wetland system. Discussion of these issues can be found in Wong et al. (1998) and design guides in Wong et al. (1999).

A preliminary sizing technique has been developed that estimates the required wetland system area for particular pollutant removal rates (Mudgway et al. 1997; Duncan 1997a, Duncan 1997) (see Appendix G).

This technique uses graphical plots of pollutant retention versus surface area of the wetland system for a range of annual run-off values. By knowing the required pollutant retention and the catchment's annual run-off, the surface area of the wetland system can be estimated.

Relationships are presented in Figure 7.39 for three pollutants; suspended solids (SS), total phosphorus (TP) and total nitrogen (TN). Each plot includes three curves describing



**Figure 7.39** Pollutant retention versus wetland system area for a range of run-off depths.

pollutant retention for three grades of average annual run-off; low (200 millimetre), medium (400 millimetre) and high (600 millimetre). This range should cover the most likely run-off values experienced in the urban areas of Victoria.

Table 2.1 in Chapter 2 lists the pollutant retention rates needed to meet SEPP requirements for a range of pollutants. By examining the intersection between these retention performance goals and the retention curves, the approximate size of the wetland system can be determined.

Once the total surface area of the constructed wetland system has been estimated, the area needs to be distributed between pond and wetland. A distribution ratio of approxi-

mately 30 per cent pond to 70 per cent wetland is appropriate for average inflow conditions. An increased wetland area may be appropriate when inflows have a large dissolved or colloidal fraction. If the inflow contains mainly coarse particulate material, an increased pond area will be more appropriate.

In areas with low rainfall and run-off it will be necessary to increase the ephemeral areas of the wetland in order to maintain successful vegetation cover.

Size is obviously not the only factor which must be taken into account when considering the design of constructed wetlands. The retention performance shown in Figure 7.39 is based upon wetlands which satisfy a number of important performance related design criteria. These include: incorporating multiple cells, having length to width ratios greater than 3:1, providing vegetated areas, incorporating permanent pools, and providing for flood storage.

It is crucial to ensure the system will not be prone to hydraulic short circuiting and that the basin morphology and water regime are compatible with the growth requirements of aquatic plants.

Some caution should be taken in predicting the performance and size of constructed wetlands. The pollutant retention performance of a constructed wetland will vary with the inflow concentration of pollutants. For higher inflow concentrations, the percentage pollutant retention will be higher for a given volume than that for lower inflow concentrations. In addition, the performance of a specific wetland configuration may vary considerably depending on a range of internal and external factors. These may not be readily quantifiable during the design phase.

### **Wetland system design consideration No. 3: Pre-treatments**

Coarse sediment passing beyond the pond area to the wetland may change the wetland's depth profile and damage its macrophyte zones. Removal of coarse sediment upstream of the wetland area can be achieved by either:

- installing a sediment and litter trap upstream of the wetland system; or
- using the pond as a coarse sediment trap.

A purpose built sediment and litter trap has a number of advantages over the second option. From an operational perspective, it is likely to result in lower relative maintenance costs and improved removal efficiency.

The option of using a pond as a sediment trap, on the other hand, presents a number of maintenance difficulties. Aside from the reduced retention efficiencies and higher costs, maintenance of the pond may impact on aquatic fauna and flora. There may also be community concerns regarding the disturbance of a 'natural' resource.

### Wetland system design consideration No. 4: Morphology

The morphology to be adopted for a particular site will often depend on the site-specific topographic conditions. Short-circuiting is one of the primary reasons for poor perfor-

<b>Pond area morphology</b>
Key objective: to maximise the effective hydraulic residence time
<p>Appropriate morphologies</p> <ul style="list-style-type: none"> <li>▪ Pond topography: appropriate pond topography can maximise the effective hydraulic residence time:                             <ul style="list-style-type: none"> <li>– establish a uniform pond cross-section;</li> <li>– appropriately locate the pond's inlet and outlet;</li> <li>– the pond length:width ratio should be within the range of 3:1 to 10:1; and</li> <li>– incorporate baffles, islands, rock walls and macrophytes to reduce velocities and distribute flow.</li> </ul> </li> <li>▪ Energy dissipation: dissipate hydraulic energy at the pond entrance to reduce inflow velocities and distribute flows across the entire pond area.</li> <li>▪ Short circuiting: minimise flow short circuiting, so that a uniform flow distribution can be achieved.</li> <li>▪ Wind mixing: consider the effects of wind and wind water mixing. Wind mixing can lead to erosion, which may propagate short circuiting.</li> <li>▪ Pond depth: pond depth should be kept between 1.5 and 2 metres. At this depth maintenance demands and macrophyte growth are minimised, while still avoiding stratification.</li> <li>▪ Maximum side slope in unfenced areas, side slopes should be graded no steeper than 8:1 for safety reasons. The grade should remain consistent above and below the water surface. If the banks are evenly graded, mosquito problems will be minimised.</li> </ul>

**Table 7.8 Pond area morphology.**

mance of constructed wetland systems. The 'hydraulic efficiency' is a term used to describe the extent to which plug flow conditions (i.e. those where the flows move evenly through the wetland) are found. A high hydraulic efficiency means there are few stagnant areas and short circuiting is minimised.

A strong emphasis needs to be placed on hydraulic issues during the design phase. This includes the shaping of both the pond and wetland to prevent stagnant zones and maximise the hydraulic efficiency. Appropriate morphologies for ponds and wetlands in a constructed wetland system are summarised in Tables 7.8 and 7.9.

### Wetland system design consideration No. 5: Outlet structures

The hydraulic characteristics of an outlet structure determine a wetland system's range of water depths and duration of inundation, termed the 'hydraulic regime' of a wetland system. Water level variations, including wetting and drying, are needed to regulate and maintain the wetland vegetation. They also significantly influence the organic content and nutrient cycling in sediments.

It is also important to be able to vary water depths during vegetation planting and establishment, and also for maintenance operations, such as weeding. A wide variation of water levels can facilitate dense vegetation growth that prevents weed infestation and provides many surfaces for sediment adhesion which enhances pollutant removal.

In summary, the outlet structure is an important consideration for:

- providing a diverse hydrologic regime;
- facilitating vegetation planting;

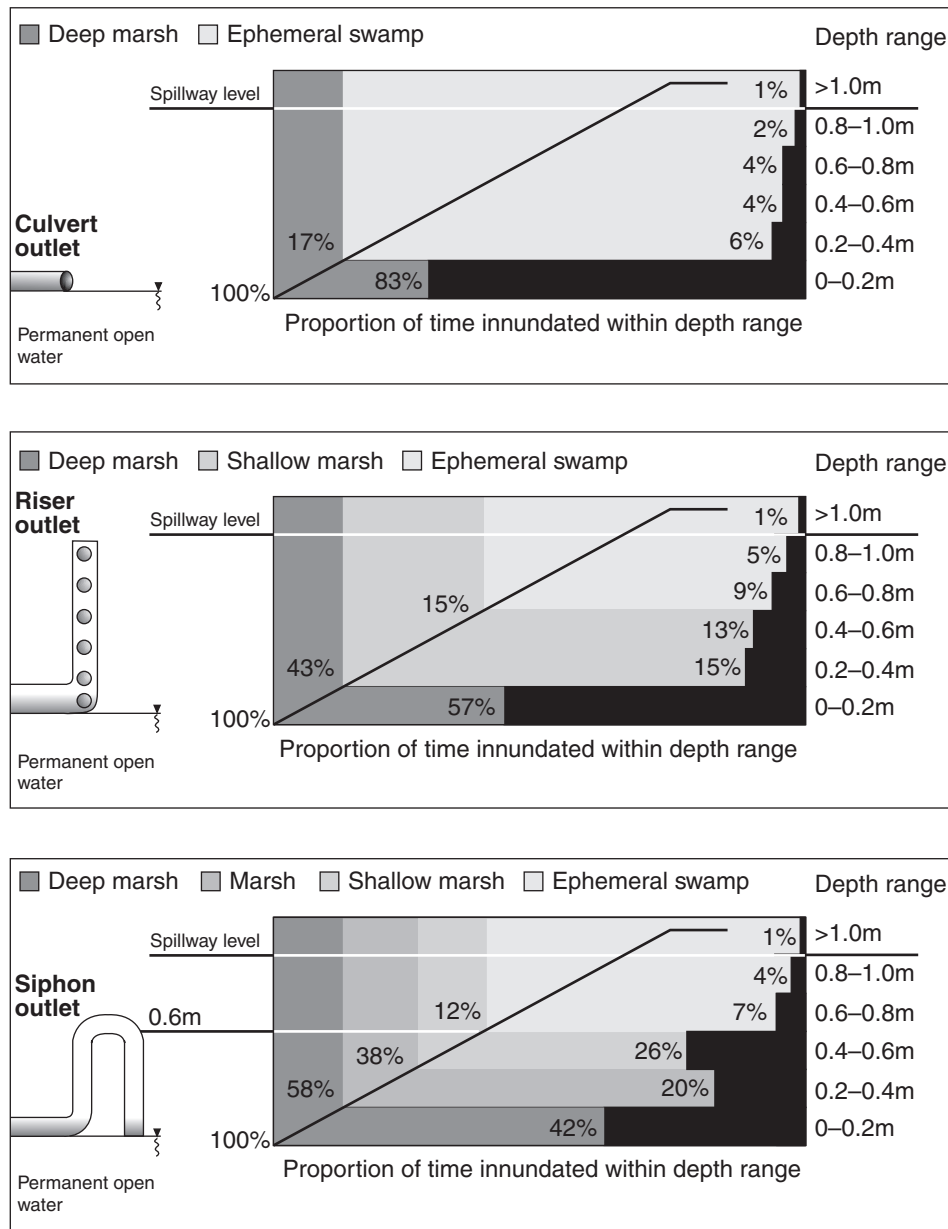
<b>Wetland area morphology</b>
Key objective: to achieve uniform flow distribution and macrophyte diversity
Appropriate morphologies
<ul style="list-style-type: none"><li>▪ Flow velocity: to minimise re-suspension of sediments and loss of biofilm, flow velocities should be retained to below 0.2 metres per second during design storms.</li><li>▪ Depth zones: a range of depth zones can be provided perpendicular to the flow path, generally less than 60 centimetres deep. This will encourage macrophyte diversity and a healthy, dense vegetation growth. Macrophyte zones should also be established perpendicular to the flow path. The species within each zone will vary according to the zone's depth, drying cycle and turbidity.</li><li>▪ Macrophyte beds: planting of different macrophyte species across a flow path should be avoided. This will minimise the development of preferential flow paths, caused by flow resistance variations between macrophyte species.</li><li>▪ UV disinfection areas: the open areas between macrophyte zones should be generally deeper than 1.2 to 1.5 metres to minimise macrophyte growth.</li><li>▪ Wetting and drying cycles: a range of wetting and drying cycles across the wetland area will help establish macrophyte diversity.</li><li>▪ Stagnation problems: poorly mixed zones should be minimised to avoid oxygen depletion and related problems. An array of open and closed water areas can be provided to encourage mixing flows.</li><li>▪ Macrophyte substrate: to assist the establishment of macrophytes, topsoil should be provided as a substrate.</li><li>▪ Side slopes: in unfenced areas, side slopes should be graded no steeper than 8:1 for safety reasons. The grade should remain consistent above and below the water surface. If the banks are evenly graded and predator species have sustainable habitat and access to all areas, mosquito problems will be minimised.</li></ul>

**Table 7.9 Wetland area morphology.**

- optimising vegetation growth during construction;
- maintaining diverse vegetation zones;
- providing weed and mosquito control; and
- facilitating wetland operation to optimise water quality improvement.

Four types of outlet are: risers, weirs, culverts and siphon outlets. Each outlet type influences the hydrologic regime depending on the catchment hydrology and basin morphology.

Figure 7.40 demonstrates the importance of an outlet structure for the hydraulic regime (water level variations) of a wetland system and hence the range of vegetation types that can be established. It shows results of a simulation of the hydraulic regime for a range of outlet structures for a wetland in Melbourne (Wong et al., 1998).



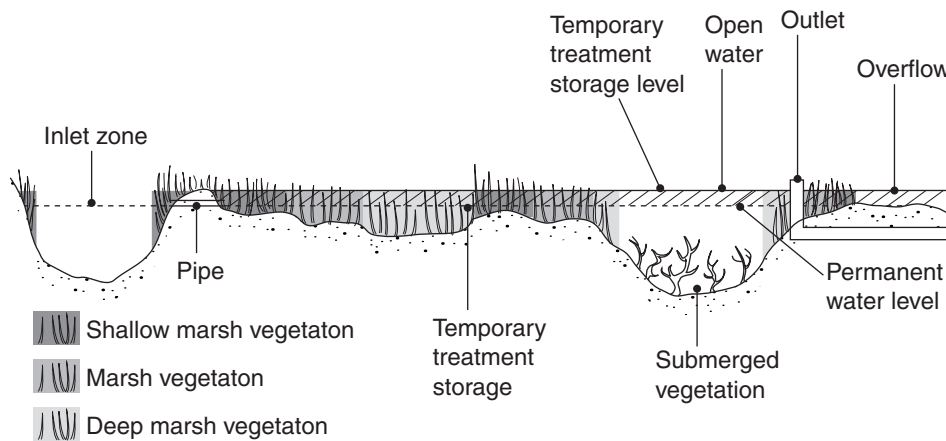
**Figure 7.40 Hydrologic regimes for different outlet types (Wong et al. 1998).**

Contrary to common practice, weirs and culverts are not considered suitable outlets for wetlands because they do not achieve an appropriate range of water level fluctuations in the wetland. This leads to a low diversity in wetland vegetation with ephemeral species occurring above the water surface and deep marsh species below the water surface.

Figure 7.40 shows that for the culvert outlet structure (similar to a weir), water depth is between 0 m and 0.2 m for a significant portion of the time. This results in a lack of diverse vegetation zones, with a distinct boundary between ‘wet’ and ‘ephemeral’ vegetation zones leaving no suitable conditions for shallow marsh species.

Figure 7.40 also shows the hydraulic regime for the same wetland fitted with both a riser and a siphon outlet structure. Both of these outlet types demonstrate an increase in the





**Figure 7.41** An example layout of macrophyte planting zones.

inundation frequency of deeper areas, and would assist the establishment of shallow marsh vegetation in addition to ephemeral and deep marsh plants. These outlet structures would therefore promote more diverse vegetation and improved pollutant removal compared to weir or culvert outlets.

Further information on outlet types for wetland systems is presented in Wong et al. (1998) and Somes et al. (1995) and in NSW Department of Housing (1998).

### **Wetland system design consideration 6: Macrophyte planting**

Macrophyte establishment is required in both the pond and wetland areas of the wetland system as shown in Figure 7.41.

Macrophyte planting in the pond area is generally limited to the edge of the system and at its inlet. Macrophytes at the pond inlet enhance sedimentation provided flow velocities are sufficiently low. Pond edge macrophytes assist with the aeration of sediments. Macrophytes within the pond system can also be used to encourage uniform flow distributions.

Macrophyte planting within a wetland area on the other hand, is far more extensive. Macrophytes are typically planted in zones or beds perpendicular to the direction of flow. Macrophyte coverage typically extends across around 75 per cent of the wetland area and is graded into three 'bands', each incorporating different macrophyte species according to the band's depth (refer to Appendix H).

The principal purpose of establishing these 'depth bands' is to achieve uniform flow across the system and to encourage macrophyte diversity.

The bands can be described to as:

- **shallow marsh:** 0 to 20 centimetres deep;
- **marsh:** 20 to 40 centimetres deep; and

- **deep marsh:** 40 to 60 centimetres deep.

The remaining 25 per cent of the wetland area is left macrophyte free. The purpose of these open water zones is to allow ultraviolet (UV) disinfection and oxygenation.

Successful planting of wetland habitats is critical to wetland performance and depends on six main factors:

- 1 planting design
- 2 site preparation
- 3 supply of planting stock
- 4 planting
- 5 water level control
- 6 establishment period maintenance.

### *1 Planting design*

The pollutant retention mechanisms occurring within the wetland area—enhanced sedimentation, filtration, adsorption and biofilm growth—all depend on the establishment of a dense growth of healthy vegetation. Planting density is also a major factor in determining wetland planting success. The greater the planting density, the less competition from weeds and the faster the system becomes fully operational.

The species growth density should be considered both above and below the normal water level. If the wetland basin is designed to allow for a water level increase during event flows, the above-normal water level plant growth can also play a filtration role.

Depending on the particular species, optimum planting densities can vary between nine and twenty-five plants per square metre (50 to 25 centimetre plant centres). Larger spreading species normally occurring in deeper water can typically be planted at lower densities than smaller species more common in shallow areas.

Selecting the most appropriate plant species requires striking a balance between each species' suitability for a particular depth range or hydrological conditions, against its ability to enhance a particular treatment process. Observation of the natural distribution of species can usually help identify the most appropriate species for each zone's depth, frequency and duration of inundation.

### *2 Site preparation*

The provision of a well prepared substratum that encourages macrophyte growth while controlling weed and non-target plant propagation, is essential.

The successful propagation of wetland plants requires an adequate covering of top soil—usually about 20 centimetres.

Plant source	Advantages	Disadvantages
Seed	<ul style="list-style-type: none"> <li>▪ Inexpensive, due to low labour intensity.</li> <li>▪ Suitable for large areas.</li> </ul>	<ul style="list-style-type: none"> <li>▪ Potential for low germination rates.</li> <li>▪ Long lead-times for plant establishment.</li> </ul>
Rhizomes (bulbs)	<ul style="list-style-type: none"> <li>▪ Higher survival rate than seed.</li> </ul>	<ul style="list-style-type: none"> <li>▪ Labour intensive, therefore costly.</li> </ul>
Transplanting	<ul style="list-style-type: none"> <li>▪ Instant plant community.</li> <li>▪ Very short lead time.</li> </ul>	<ul style="list-style-type: none"> <li>▪ Labour intensive, therefore costly</li> <li>▪ Weeds may be imported to target site.</li> <li>▪ Difficult to achieve uniform cover.</li> </ul>
Nursery propagated material	<ul style="list-style-type: none"> <li>▪ Precise control over what species is planted.</li> <li>▪ Vegetation establishes quickly.</li> </ul>	<ul style="list-style-type: none"> <li>▪ Labour intensive, therefore costly.</li> <li>▪ Requires long lead time (6–12 months) for propagation.</li> </ul>
Soil cores	<ul style="list-style-type: none"> <li>▪ Diverse and complex community developed in a short period.</li> </ul>	<ul style="list-style-type: none"> <li>▪ Excavation, transport and replanting of cores is laborious and expensive.</li> </ul>

**Table 7.10 Sources of wetland plants: advantages and disadvantages of each source (after Hammer 1992).**

Weed infestation, particularly if construction is in established channels, can be one of the biggest challenges in establishing wetland vegetation. Weed control can be achieved by physical removal using either machinery, manual labour or herbicides. Glyphosate is a recommended herbicide as it quickly adsorbs to soil particles and breaks down. To maximise the effectiveness of spraying, the site should be as dry as possible, because wet conditions will allow many wetland weeds to survive.

### 3 Supply of planting stock

Wetland plants may be sourced from a range of locations: seed stock, rhizomes (bulbs), transplanting, nursery propagated material, and soil cores taken from existing wetland sites.

The source of plants chosen will affect the total cost of the project, the time taken for plants to establish, the variety of plants available and the extent of weed control required. Alternative sources of plants are described in Table 7.10.

**Seeds:** this is the least expensive method of establishing wetland vegetation. Wetland plants have low seed germination rates, so seed planting can result in long lead times for the establishment of mature plants. The use of seed is only recommended for large sites, where planting and planting stock costs will be high.

**Rhizomes:** these have the advantage of offering a larger unit of biomass per plant, so they are established more quickly than seeds. Rhizome harvesting sites, however, may be limited and the harvesting itself will damage the source site. Harvesting and planting is labour intensive, so this approach is costly.

**Transplanting:** the transplanting of plant material from existing vegetation stands will establish vegetation very quickly at a new site. Once again, the transplant exercise is labour intensive, so it attracts higher costs. Transplanting also brings with it the hazard of weed importation from the source site.

**Nursery propagated material:** using nursery propagated plants is the most common and preferred method for establishing vegetation in wetlands. Although long lead times are required for propagation, propagated material offers a low risk of disease, a high level of control over the species planted and rapid establishment at the required density. A lead time of six to twelve months is often required when ordering wetland tube stock.

**Soil cores:** these consist of 100 millimetre diameter cores containing seeds, roots and rhizomes, which are taken from an existing wetland and transplanted to the new site. This can be an expensive alternative, often with limited suitable source sites available for core excavation.

#### *4 Planting*

The planting technique chosen is normally determined by the type of planting stock, the local terrain and site conditions. Appropriate planting is vital to the functionality of the wetland system and is usually undertaken by a specialist contractor.

The key to successful planting is to minimise damage to the stock during planting. As a result, sensitive planting procedures typically rely considerably on manual labour.

#### *5 Water level control*

The establishment conditions for many wetland plant species are often very different to their typical growing conditions.

Prior to planting, it is usually necessary firstly to flood the system, then reduce the water levels. A water depth of less than 20 centimetres is typically required during the establishment of even the largest of emergent macrophytes. Good control over water level fluctuations is crucial during this phase.

#### *6 Establishment period maintenance*

During the establishment phase, plant growth and condition should be monitored closely. It is during this period that plantings are most vulnerable to impacts and damage. Factors that need particularly close attention include:

- water level;
- weed invasion; and
- animal damage.

More information on planting wetlands can be found in Somes et al. (1995).

### **Wetland design consideration No. 7: Maintenance**

The morphology and typically large size of wetlands can make maintenance access difficult. It is important, therefore, that operations and maintenance considerations be addressed during the design of the wetland.

For further details refer to the 'Maintenance' section outlined in 7.9.1.

### **Wetland design consideration No. 8: Loading of organic matter**

Organic material can smother wetland sediments, creating anaerobic conditions, which can lead to the release of phosphorous. Minimising organic matter loading to a constructed wetland is important for the minimisation these impacts (refer Lawrence and Baldwin 1996).

Reducing organic matter inputs to the wetland is best achieved by source control or pre-treatments. If the control of organic matter loads cannot be achieved using these techniques, it may be necessary to increase the surface area of the wetland—in effect, to 'dilute' to the organic loading. An alternative technique is to incorporate regular wetting and drying cycles in the wetland system maintenance. Drying the organic sediments increases the rate of organic degradation and progressively renders the phosphorus less available.

### **Wetland design consideration No. 9: Safety issues**

There are a range of safety issues that require consideration when designing constructed wetlands. Most specifically, these relate to the potentially hazardous areas around the pond area inlet and outlet—areas of high water velocities and steep sloped banks. Potential solutions include the use of safety rails or barriers, signage and water velocity control techniques. Inlets and outlets can also be designed to avoid trapping fauna.

Occupational health and safety considerations for maintenance staff should be considered carefully during the design stage.

### **Wetland design consideration No. 10: Multiple uses**

Constructed wetland systems can often be designed for multiple uses. Wetland systems that incorporate multiple uses can increase the value of adjacent land and hence the benefit–cost ratio of the stormwater system.

Multiple objectives should be evaluated during the design development phase. Involving communities and stakeholders in the design process can often help achieve these multiple use objectives.

Care should be taken, however, to avoid compromising the primary objective of a stormwater treatment system—to achieve enhanced stormwater quality—in the quest to meet the demands of other beneficial uses.

### **Wetland design consideration No. 11: Groundwater considerations**

Groundwater inflows and outflows can have a significant effect on a constructed wetland system. Groundwater chemistry can affect water quality and processes such as sedimentation and vegetation growth. Wetlands may need either to be isolated from the groundwater influence or designed to accommodate its influence.

### **Wetland design consideration No. 12: Mosquito control**

Mosquitoes proliferate in stagnant shallow water, usually less than 40 centimetres deep. Techniques for minimising mosquito problems include:

- **bank grading:** evenly graded side slopes will minimise the potential for localised ponding;
- **water depth control:** management of water depth, particularly during summer;
- **minimisation of stagnation zones:** avoiding the development of zones with poor water movement;
- **reduction of litter:** minimising litter input to the wetland, as mosquitoes can breed in litter; and
- **predation:** designing the wetland system as a viable ecosystem that includes predators of mosquito larvae.

Artificial control techniques can also be used including aerators, sprinklers and sprays. A mosquito risk analysis can be undertaken (NSW Department of Housing 1998; Wong et al. 1998).

### *References and further information*

- Duncan, H.P., 1997, Personal communications, Cooperative Research Centre for Catchment Hydrology.
- Duncan, H.P., 1997a, 'Urban stormwater treatment by storage'.
- Hammer, D.A., 1992, *Creating Freshwater Wetlands*.
- Hunter, G., 1995, 'Constructed wetlands: safety issues'.
- Lawrence, A.I. and Baldwin, S., 1996, 'Development of an urban pond quality model'.
- Mudgway, L.B., Duncan, H.P., McMahon, T.A. and Chiew, F.H.S., 1997, *Best Practice Environmental Guidelines for Urban Stormwater. Background Report*.
- NSW Department of Housing, Housing Production Division, 1998, *Managing Urban Stormwater: Soils and Construction*.

Russell, R.C. and Kuginis, L., 1995, 'Constructed wetlands and mosquitoes: some problems and some solutions'.

Schueler, T.R., 1992, *Design of Stormwater Wetland Systems: Guidelines for Creating Diverse and Effective Stormwater Wetland Systems in the Mid-Atlantic Region.*

Somes, N.L., Breen, P.F. and Wong, T.H.F., 1995, 'Establishment of wetland vegetation for runoff control systems: design and installation considerations'.

Wong, T.H.F., Breen, P.F., Somes, N.L.G. and Lloyd, S.D., 1998, *Managing Urban Stormwater Using Constructed Wetlands.*

## **7.10** **Flow management: index**

---

<b>Design tool</b>	<b>Page no.</b>
Flow management design tool No. 1: Filter strip	220
Flow management design tool No. 2: Swale drain	222
Flow management design tool No. 3: Distributed sub-catchment storages	224
Flow management design tool No. 4: Hybrid channels	225
Flow management design tool No. 5: Retrofitting grassed floodways	226



### 7.10.1 Objectives and principles of flow control

---

Catchment urbanisation leads to increases in the volume and rate of stormwater run-off. This is due to an increase in the amount of impervious surfaces and improved hydraulic efficiencies in the stormwater conveyance system. These changes affect receiving environments by altering velocity profiles, suspended load and bedload characteristics, and by increasing turbulence. This can result in ecosystems dominated by a limited number of species that can withstand the environmental stresses associated with an urbanised catchment.

Carefully developed flow management strategies can provide opportunities to both minimise flood risk, and protect or enhance receiving water ecosystems and local amenity.

Strategic catchment planning should include the following objectives and principles:

- **impact minimisation:** minimise waterway disturbance caused by the alteration to flow regimes during catchment urbanisation and drainage management programs;
- **natural drainage system protection:** protect channel form and aquatic ecosystems from flow-related impacts. Reductions in run-off volume and flow rate are key factors in reaching this objective—the peak discharge of the 1.5 year ARI should be limited to that of pre-urbanisation level. Strategies to limit the direct connection of impervious areas to aquatic ecosystems can provide flow management benefit for aquatic habitat protection as well as water quality improvements; and
- **integrated stormwater management:** adopt an integrated approach to stormwater system management that meets both hydraulic capacity and waterway protection objectives.

There is considerable scope to incorporate these objectives into the overall design of stormwater drainage systems during the planning phase for new urban development. However, in established urbanised catchments, the opportunities are often limited. Modifying the existing stormwater drainage infrastructure will require catchment managers to be opportunistic in identifying short term and long term priorities for protection and rehabilitation of urban aquatic ecosystems.

This section describes a number of general techniques for managing flow related impacts of urbanisation. Flow management design tools are provided as examples of some of these techniques.

### 7.10.2 Flow management techniques

---

A range of techniques are available for managing flow and flow-related impacts within urban areas. Flow management techniques range from localised site controls to flow detention systems at the sub-catchment scale. The choice of techniques is catchment dependent—in many cases a combination of techniques will be most effective.

## 1 Maintaining natural drainage

Maintaining the natural drainage system is often the most effective and least expensive way to minimise flow impacts. This is most easily adopted in greenfield sites. Where possible:

- maintain natural channels and flood plains, or incorporate natural channels into the design of hybrid channels (see point 4); and
- use swale drains, check banks and grass buffers as part of the stormwater conveyance system to improve water quality and reduce peak discharges.

## 2 Run-off control

Run-off control measures can be used to treat run-off from roofs and other areas that are highly impervious. These measures include reducing or minimising the impervious area that is directly connected to the underground stormwater system, on-site stormwater reuse, and using detention basins and infiltration systems. Source run-off control should be used to complement other measures, rather than as the only solution.

Run-off control techniques include:

- **local collection and detention:** design access places and road crossfalls to direct run-off to local collection and detention areas;
- **minimising the extent of paving:** use porous pavements, incorporate shorter driveways, smaller road widths, and footpaths on only one side of the road;
- **housing run-off:** concentrate domestic run-off for treatment to one or two points in the development;
- **grass swales:** provide areas of grass swales along verges, to reduce flow velocities or to permit stormwater infiltration;
- **roadway design:** design roadways and parking areas to incorporate detention areas and vegetation; and
- **public area design:** integrate infiltration/detention basins in public open areas. Locate local public open space at the base of cul-de-sacs to accommodate local run-off.

## 3 Distributed storages

Small storages distributed throughout a catchment help to reduce peak flow rates and provide a greater degree of protection than one large storage at the outlet. These can be used either in combination with natural channels, or as an alternative flow management measure. Storages can be readily retrofitted to existing urban environments, subject to land availability.

### *Retarding basin design*

Retarding basins are commonly used in urban catchments and are often designed to limit downstream flooding impacts from catchment development. Commonly, retarding basins are designed to attenuate the peak 100 year ARI discharge to pre-development level. However, designing retarding basins to also attenuate the 1.5 year ARI flow to pre-development level can benefit receiving waters without compromising drainage and flood protection requirements. The design of new retarding basins or retrofitting existing basins can range from minor modifications of conventional outlet design to the full implementation of water pollution control wetlands within the retarding basins.

## **4 Hybrid channels**

To ensure flood protection, traditional stormwater management has increased the hydraulic discharge efficiency of urban land and waterways, with little consideration of flow velocity.

However, it is possible to design channel modifications that protect aquatic ecosystems and provide flood protection by constructing a 'natural' low flow channel within a high flow channel. Appropriate design can also offer aesthetic and water quality benefits (see Flow management design tool No. 4).

### **7.10.3 Flow management design tools**

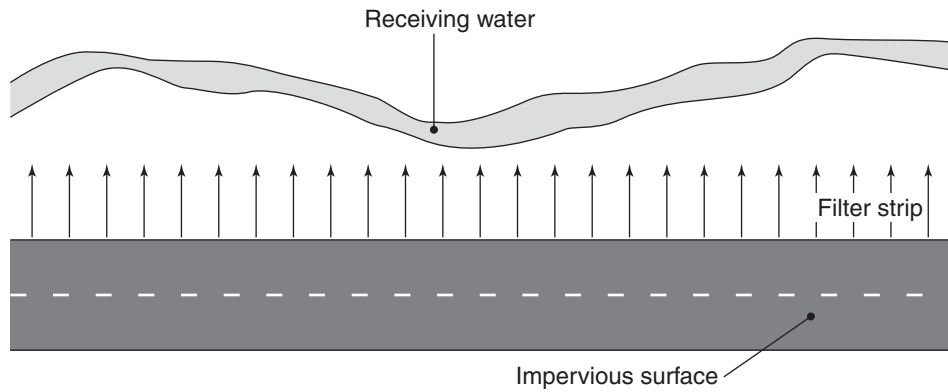
---

#### **Flow management design tool No. 1: Filter strip**

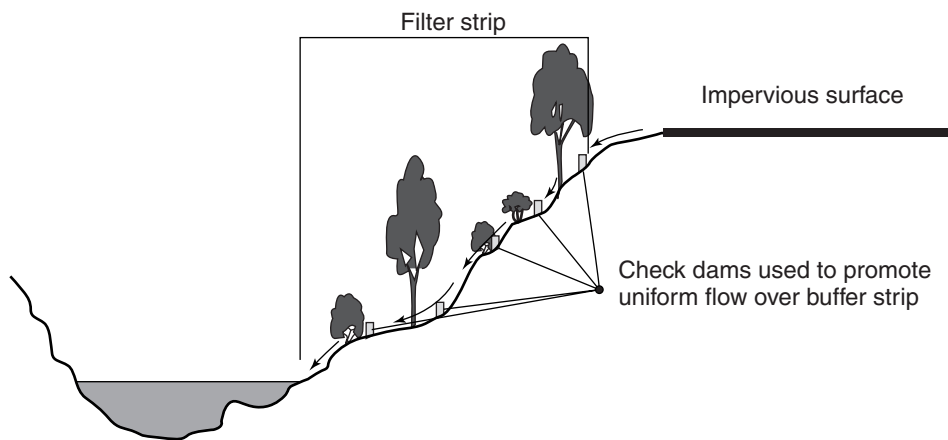
Stormwater management using filter strips/buffer strips involve the discharge of impervious area run-off laterally to the creek via a zone of densely vegetated ground cover. Filter strips promote infiltration, filtration and attenuation of stormwater run-off. Uncontrolled overland flows are discouraged thereby reducing the risk of flow channelisation and erosion. For further detail see Appendix C.

#### *Design considerations*

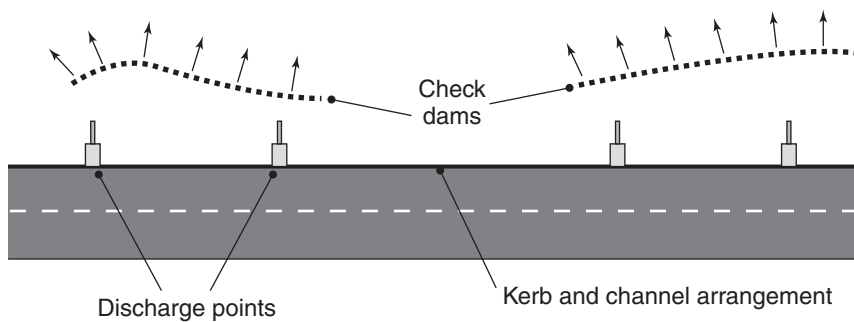
- dense, evenly distributed ground cover should be promoted;
- minimum height of vegetation should exceed maximum depth of overland flow expected;
- excessive shading by trees with dense canopy which may result in a patchy distribution of ground cover should be avoided;
- uniform flow should be discharged from impervious areas to filter strip (Figure 7.42);
- flow spreaders in the form of check dams and benches need to be constructed at regular intervals along the face of the filter strip if slope exceeds 5 per cent (Figures 7.43);
- areas of a filter strip where flows may naturally converge should be underlaid by rocks and geotextile fabric prior to planting to provide additional protection against erosion;



**Figure 7.42 Plan illustration of filter strip run-off management option.**

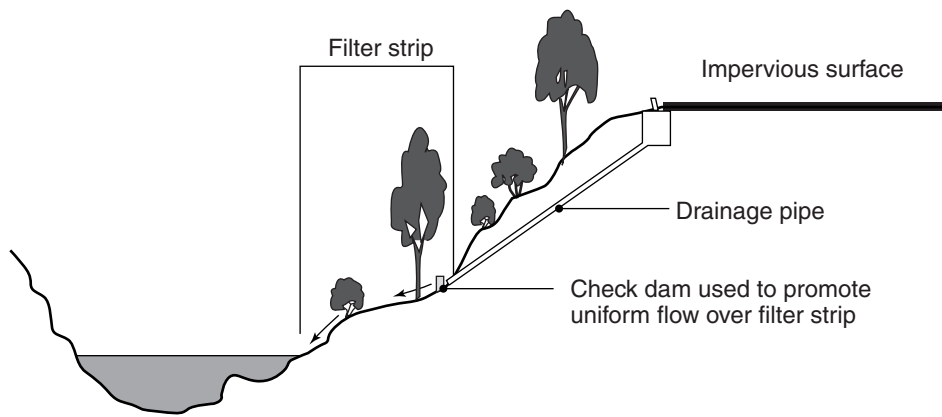


**Figure 7.43 Section illustration of filter strip management option.**

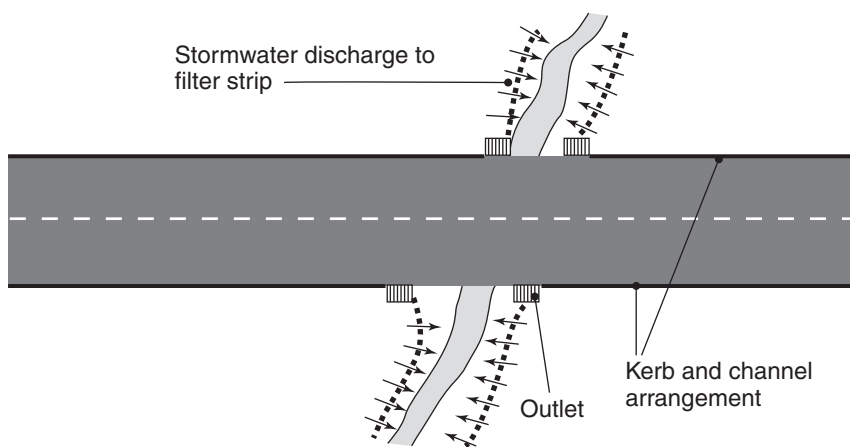


**Figure 7.44 Plan illustration of kerb and channel and filter strip run-off management option.**

- in circumstance of steep slope, it may sometimes be more appropriate to collect road run-off by means of the conventional kerb and channel arrangement and discharge the run-off at locations where slopes do not exceed 17 per cent (Figures 7.44 and 7.45); and
- when a road crosses a creek line, it is often more appropriate to run the filter strip parallel to the creek line and pipe the flows to the filter strip (Figure 7.46).



**Figure 7.45** Section illustration of kerb and channel and filter strip run-off management option.



**Figure 7.46** Plan illustration of kerb and channel and buffer strip along creek.

### Flow management design tool No. 2: Swale drain

A swale drain is a more suitable option when the conveyance of run-off to a designated discharge point is required. Grass swales can attenuate stormwater run-off and promote infiltration during minor storm events. Run-off is discharged from an impervious area into a swale drain as illustrated in Figure 7.47. If the slope and terrain between the impervious area (e.g. road) and the receiving water is too steep or undulating a combination of swale drain and discharge pits may be used. For further detail see Section 7.8.

#### *Design considerations*

- the slope and width of the swale drain should be designed to avoid flow velocity above 0.3 m/s for the 1 year ARI event and 1 m/s for the 100 year ARI event;
- the longitudinal slope of the swale should not exceed 4 per cent;
- side slopes should not exceed 1(v):3(h);
- if the slope of the terrain to the receiving water exceeds 4 per cent, discharge pits should be located at regular intervals (e.g. 1 km intervals), at which the stormwater is conveyed to the creek via a pipe outlet. An energy dissipater or flow distributor

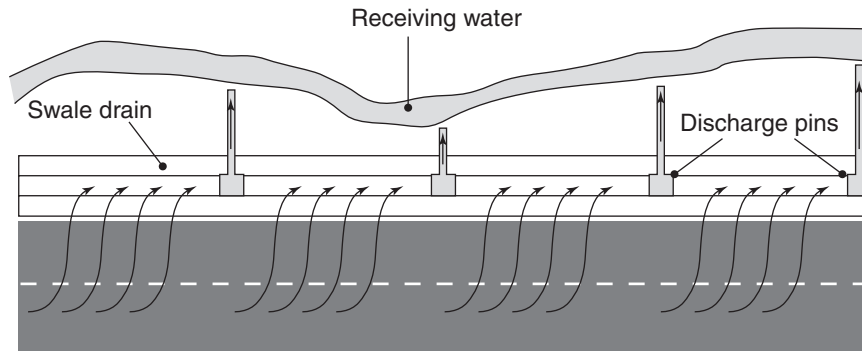


Figure 7.47 Plan illustration of swale drain run-off management option.

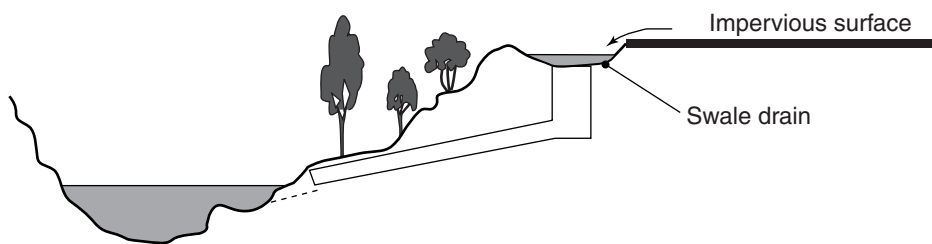


Figure 7.48 Section illustration of swale drain run-off management option.

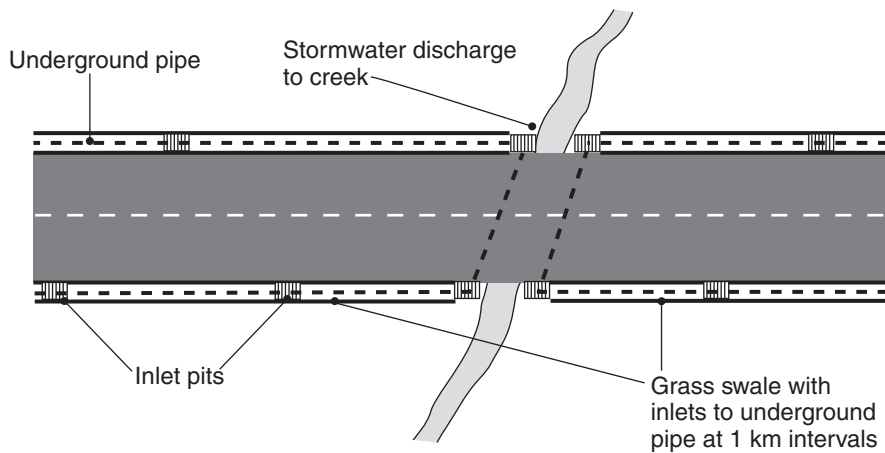


Figure 7.49 Plan illustration of swale drain/drainage pit option.

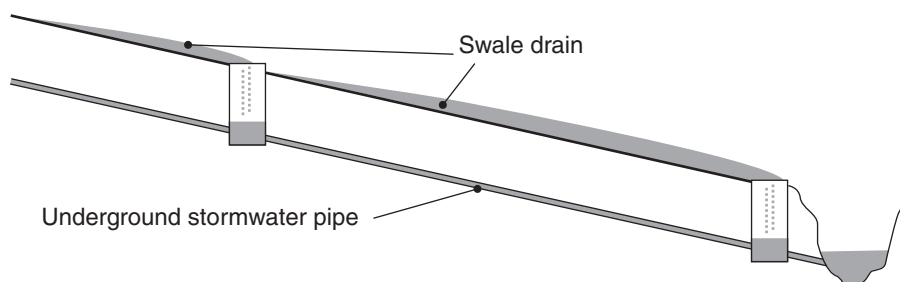


Figure 7.50 Longitudinal illustration of swale drain/underground pipe system.

should be located at the outlet to reduce flow impact at the entry point to the receiving water (Figures 7.47 and 7.48);

- flat terrain may be required under drains to avoid ponding of surface water;
- if the vertical alignment of the road is relatively steep, swale drains can be used to convey run-off from small sections of the road into a more formal drainage system consisting of inlet pits and an underground pipe (Figures 7.49 and 7.50);
- mowing should be kept to a minimum. Mower blades should be set at the highest level to maximise the height of the vegetation in the water column during run-off events; and
- swales can be used as a pre-treatment for other stormwater treatment measures.

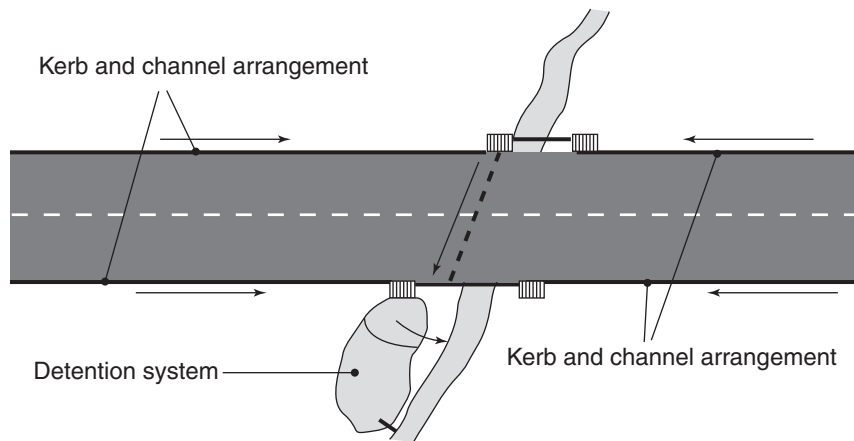
### **Flow management design tool No. 3: Distributed sub-catchment storages**

Small storages distributed throughout a catchment delay run-off and reduce peak flows further downstream. Distributed storages may consist of dry detention basins, wet detention basins or wetlands (Figure 7.51). For further detail see Section 7.8.

Several small storages, distributed on catchment tributaries, are recommended in preference to a smaller number of larger storages. Storages may be either dry basins, reserves, wetlands or lakes. The storages should be sized so that peak flows up to a 1.5 year ARI event are attenuated to pre-development level. Where possible, storages should be designed to achieve not only water flow control but water quality treatment, amenity and landscape benefits.

#### *Design considerations*

- length to width ratio should be greater than 2 (L):1(W);
- pre-screening of gross pollutants is recommended;
- a by-pass system for high flows is highly recommended;
- basin sizing should be based on a balance between the annual proportion of rainfall to be detained and the desired detention time;
- flood routing analysis should be undertaken to determine the degree of flood peak attenuation and shift in time of peak discharge in receiving waterways. The effect of co-incident release of detained waters from multiple storages and subsequent rainfall events needs to be considered;
- promoting uniform distribution of inflow volume within basin—inadequate selection of the size and shape of the detention system or design of outlet will result in short-circuit flow paths and dead zones;



**Figure 7.51 Plan illustration of kerb and channel arrangement directing flow into a constructed wetland.**

- protecting outlet structures against blockage;
- if incorporating a wetland system into the design, ensuring the botanical design matches the wetness gradient of each vegetated zone in the system; and
- in steep terrain, designing detention basins as a series of cells.

#### **Flow management design tool No. 4: Hybrid channels**

Hybrid channels consist of a low flow channel providing habitat for aquatic organisms and a grassed high flow channel which is hydraulically efficient for flood protection purposes.

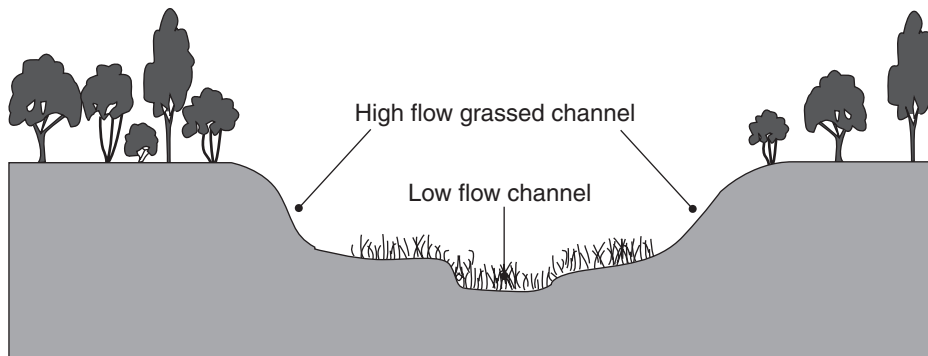
Figure 7.52 illustrates the layout of a hybrid channel. Here, a natural low flow channel is incorporated within a modified waterway providing aquatic habitat while maintaining a hydraulically efficient high flow channel.

The low flow section of a hybrid channel should be designed to provide a range of substrate conditions and avoid excessive entrainment of bed materials. Pool and riffle sequences should be used to provide habitat diversity and refuge sites for in-stream fauna. Owing to the limited supply of bed materials such as cobbles and gravels in urban catchments, it is important that the low flow channel be designed to maintain these materials by keeping flow velocity to below 0.7 m/s for the 1 year ARI event. Finer materials, which are easily transported at this velocity, are readily replenished during low flow conditions. Occasional flushing and entrainment flows are considered necessary for maintenance of ecosystem health by removing fine sediment from interstices in gravel beds. Natural woody debris may be provided in the low flow channel where appropriate.

#### *Design considerations*

- large woody debris and pool and riffle sequences should be included in the low flow channel;





**Figure 7.52 Provision of a natural low-flow channel within a hydraulically efficient urban waterway.**

- aquatic vegetation can be used to stabilise substrate and provide variation in habitat in the low flow channel;
- the low flow channel should be designed such that the flow velocity for the 1.5 year ARI peak discharge is only just sufficient to entrain the riffle substrate;
- flow velocity should not be able to displace large rocks (i.e. between 150 to 200 mm) that may have been placed in the channel as part of stabilisation works;
- high flow channel should be grassed, providing a hydraulically efficient waterway; and
- high flow channel should be sized according to the 100 year ARI event

#### **Flow management design tool No. 5: Retrofitting grassed floodways**

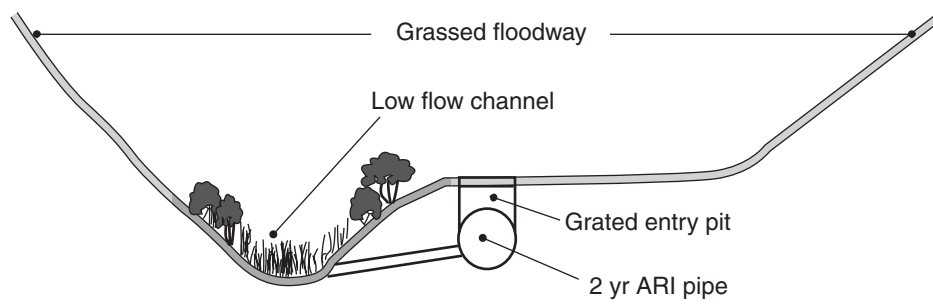
Grassed floodways are commonly used to provide efficient flow conveyance of run-off up to the 100 year ARI event. These floodways typically consist of a low flow pipe (of 2 year ARI capacity) overlaid by a wide trapezoidal grassed channel as shown in Figure 7.53. Retrofitting grassed floodways involves the diversion of low flows into re-established natural channels without compromising the flood protection associated with the grassed floodway. The re-established natural channel provides habitat and continuity of the aquatic ecosystem (Figure 7.54).

#### *Design considerations*

- divert low flow from existing 2 year ARI pipe into re-established 'natural' channel (Figure 7.54);
- use grated entry pits placed at regular intervals along the 2 year ARI pipe to allow flood water to inflow into the low flow pipe;
- re-establish natural channel with 1 to 1.5 year ARI discharge capacity;
- pool and riffle sequences should be included in the re-established natural channel; and
- aquatic vegetation can be used to stabilise substrate and provide variation in habitat in the re-established natural channel



**Figure 7.53** Grassed floodway suitable for re-establishment of low flow channel.



**Figure 7.54** Cross-section of a grassed floodway combined with a re-established natural low flow channel.



# Appendices

---

## **Appendix A: Example of a litter trap action plan**

---

Adapted from 'Moreland City Council Litter Trap Action Plan', a report by Allison Partners for Moreland City Council, 1998.

### **1 Introduction**

This case study provides an example of how to develop a Litter Trapping Action Plan based on work undertaken in the city of Moreland.

Moreland City Council is approximately 5 kilometres north of central Melbourne and is typical of inner city suburbs. The council undertakes regular street sweeping, has widespread usage of litter bins and employs litter officers for particular problem areas. Despite these efforts litter is recognised as a problem pollutant for stormwater and the receiving creeks and rivers.

The approach is based on targeting high litter generation areas.

Structural stormwater treatments such as litter traps can be expensive to install and maintain. Therefore, litter traps should generally be used where litter generation rates are high, such as commercial areas. Litter traps in residential areas with low litter generation rates will commonly trap much more vegetation than litter. Maintenance costs can therefore be significant for relatively low levels of litter trapped. In areas with low litter generation rates (e.g. typical suburban low density residential), source controls are likely to be the most effective measure. The approach taken here is to target the areas that produce the highest litter loads.

### **2 Methodology**

The Litter Trap Action Plan was developed through a five step process. The steps were:

- 1 identifying high litter generation areas from examination of land-use maps, consultation with council officers and field inspections;

- 2 determining drainage pathways for each high generation area from examination of the drainage plans;
- 3 determining the suitability of each area for different types of litter trapping systems (i.e. either source, in-transit or end-of-pipe traps);
- 4 identifying suitable locations for installing litter traps (including field inspections); and
- 5 recommending a list of potential litter trap locations, based on achieving maximum litter trapped per dollar spent.

### **3 Litter generation areas**

The areas within council that are likely to generate large amounts of litter should be determined by examining land-use maps and identifying commercial, industrial and other areas likely to produce litter. Research in Melbourne has found that commercial areas can contribute twice as much stormwater litter as residential areas, and light-industrial areas also produce more than residential areas. This suggests that it is these areas that should be targeted for a stormwater litter trapping program.

The areas can be grouped into categories such as: major commercial, light industrial, medium-sized commercial, and local commercial litter generation areas—as was done in the Moreland City Council case study.

Major commercial areas are large retail outlets likely to produce the most litter (e.g. large shopping centres). Light industrial areas generally have automotive industries as well as any other light industry, with associated fast food outlets. There can also be high traffic loads in these areas. Medium sized commercial areas are typically a strip shopping centre (e.g. group of twenty shops or more), often with a supermarket and car parks. Local commercial areas are generally small strip shopping areas with between three and ten retail shops.

In the City of Moreland there were five major commercial, six light industrial, eleven medium sized commercial and twenty-nine local commercial areas identified for the study.

#### **Example: Glenroy Shopping Centre (major commercial area)**

The Glenroy shopping area includes regional strip shops as well as several supermarkets and other retail outlets. The majority of the area is on the west of the railway line, although there are retail outlets along Wheatsheaf and Glenroy Roads to the east of the railway line.

The area is typically busy with retail activity, pedestrians and car parking along either side of Pascoe Vale Road, and larger car parks present to the east of the railway line.

#### **4 Drainage pathways from litter source areas**

The next task is to identify the drainage pathways from the largest litter generation areas and discuss the suitability of various litter trapping alternatives for the individual drainage networks.

It is particularly important to identify drainage paths that convey run-off from several of the litter generation areas or where 'hot-spots' are serviced by more than one drainage system.

##### *Major and medium-sized high litter generation areas*

In-line litter traps are generally preferred in major and medium sized litter generation areas where the majority of the source area drains through one outlet, and that outlet doesn't capture significant run-off from many other areas. In-line litter traps have the advantage of requiring that only one location be visited for maintenance. Should the inlets from the source areas lead into different drainage networks or be diluted with run-off from other locations (with lower litter generation potential), entrance litter baskets are likely to be more appropriate.

##### *Local high litter generation areas*

The small size of many local commercial areas means that in-line traps may not be cost effective. In these cases, entrance type baskets may be more appropriate. They can target the pits that are likely to contribute the most litter without treating water from areas that do not produce much stormwater litter.

### **Example: Glenroy shops**

#### **Drainage pathways**

The main commercial area of Glenroy is along Pascoe Vale Road and east along Glenroy and Wheatsheaf Roads. The area drains in two directions: south-west and south-east from either side of the railway line.

All the commercial area on the west side of the railway line is drained through one outlet that is directed under Prospect Street (Melways 16 G3) in an 825 mm diameter drain. Approximately half the catchment is residential in Prospect Street, however, the drain runs north along Pascoe Vale Road until Gervase Avenue, therefore collecting many road pollutants in addition to all the busy retail areas west of the railway.

#### **Litter trapping options**

Prospect Street is a quiet residential area with access to the drain from the roadway and is a potential location for an in-line litter trap. The most appropriate treatment for this area would be an in-line litter trap installed on an 825 mm drain (Prospect Street) to capture run-off from the commercial area west of the railway line.

East of the railway line, the commercial and light industrial areas drain into three different pipes draining down Glenroy, Wheatsheaf and Waterloo Roads. There are approximately twenty-five drain inlet pits that service the strip shopping areas (although draining into different catchments). These inlets could be retrofitted with entrance baskets to prevent a larger in-transit trap being required on three drains downstream of the commercial area.

## 5 Litter trap locations

Potential locations for traps can be assessed according to their suitability for installation with particular types of litter traps (e.g. at source or in-line).

The suitability of a location for installing a litter trap depends on:

- the presence of any existing stormwater controls;
- the location in the drainage network relative to the high litter generation area;
- pipe system details (e.g. sizes, gradients, etc.);
- proximity to underground services or any other space constraints;
- access to the site for maintenance; and
- potential disturbance to the local community during construction and maintenance.

After identifying any existing litter traps in the area, the next step is to identify the most suitable type of litter traps (either entrance or in-line traps) for each high litter generation area. The following is a guide to the suitability of various trapping systems.

**Entrance traps:** installation suited to smaller areas.

**Small in-line traps:** suited to small to medium sized areas, except where inlets from the source area lead into different drainage networks or where flow is diluted with run-off from other low generation areas (consider entrance traps in these situations).

**Large in-line end-of-pipe traps:** suited to medium to major generation areas or where a number of smaller areas are serviced by the same drainage pathway.

Based on field inspections of the drainage pathways, a final recommendation can be made on litter trap locations. However, in the case of in-line litter traps, detailed investigations would be required before construction in order to size the trap and take account of more specific issues such as proximity to other underground services.

## 6 Priorities and recommendations

Along with the potential location for installations, estimates of the gross pollutant loads and cost ranges for installation and maintenance for the recommended works should also be made.

### **Example: Prospect Street (Glenroy shops)**

The main Glenroy commercial area west of the railway drains down the southern side of Prospect Street. It is a quiet residential street with a wide easement. There is potentially a location for installing an in-line litter trap. There appears to be a considerable slope down Prospect Street, which may aid the performance of some in-line traps.



**Prospect Street looking west along drainage path.**

Litter loads for each trap location can be estimated using a decision support system derived from data collected from a study in Melbourne (Allison et al., 1998b). The computer program estimates litter loads from catchment size, land-use and rainfall information.

Costs for traps can be estimated using the size of the catchment areas and cost ranges presented in Chapter 7 of these Guidelines. The values in the Guidelines estimate trap costs in Melbourne using the size of the catchment as the determining factor.

For the Glenroy shopping area, a combination of in-line and entrance traps is recommended. These potential works need to be ranked against other potential litter trap locations in the City of Moreland.

### **Example: Moreland City Council**

A combination of in-line and entrance type litter basket traps were proposed for Moreland City Council. Twelve medium sized commercial and light industrial areas and all twenty-nine local commercial areas were recommended to be installed with entrance type baskets. Ten locations were recommended for in-line traps.

Table A1 presents the ranking of the ten suggested locations for in-line litter traps in the City of Moreland. It includes some details relevant to design and construction issues, estimates the litter and gross pollutant load (i.e. including vegetation) from each catchment and gives a range of likely construction costs for each trapping location.



<b>Example: Moreland City Council in-line trap recommendations</b>						
<b>Potential in-line litter traps: prioritised locations</b>						
<b>Location</b>	<b>Catchment areas</b>	<b>Installation issues</b>	<b>Estimated annual litter loads* (kg)</b>	<b>Estimated annual gross pollutant loads* (kg)</b>	<b>Estimated installation cost range (\$'000s)**</b>	<b>Receiving waterway</b>
Prospect Street	Glenroy shops	quiet residential street, street slope, drain under easement, captures Glenroy shops west of railway, 825 mm diameter pipe	1 100	3 400	35–105	Moonee Ponds
Poplar Road	south Sydney Road, Phoenix Street industrial area, Grantham Street shops	outlet into natural stream reach, large catchment area, 1 450 mm pipe diameter, adequate pipe slope and space for most installations, in Royal Park—not in Moreland City	2 900	8 100	100–300	Moonee Ponds
Union Street	south Sydney Road	isolates a large section of Sydney Road shops, pipe under road, mild slopes, traffic disturbance during construction and maintenance, 825 mm pipe diameter	1 300	3 000	28–84	Moonee Ponds
Montifore Street	Gaffney Street light industrial area	light industrial and residential catchment, pipe under roadway, quiet residential area, mild slope ?, 1 050 mm diameter pipe	700	2 100	40–120	Moonee Ponds
Williams Street	Gaffney Street light industrial area	busy light industrial area and pipe under busy through road, pipe under east gutter, 900 mm diameter, steep slope	600	1 000	22–66	Merri
Dawson Street	Gaffney Street light industrial area	busy light industrial area, drain under roadway (towards edge as it goes south), steep slope, busy through road, 600 mm diameter pipe	400	700	15–45	Merri
Fallon Street	Phoenix Street light industrial area	residential/light industrial catchment, pipe under roadway, large trees on median strip, 900 mm pipe with mild slope, traffic diversions during construction and maintenance	300	700	15–45	Moonee Ponds
Lygon Street	south Lygon Street, Barkley Square, south Brunswick light industrial activity	large commercial/light industrial catchment, pipe under very busy roadway but located under west gutter, open space adjacent to drain at Park Street, 1 275 mm diameter, traffic diversions may be required	1 900	5 400	65–195	Merri
Albion Street	Albion Street shops, Holmes Street shops and light industrial area	commercial/light industrial and residential catchment, located under dead-end road, deep pipe at outfall, 1 000 mm diameter, potentially space further upstream along reach	900	3 000	40–120	Merri
Harding Street Laneway	Sydney Road north shops	825 mm pipe under laneway, run-off is mainly from Sydney Road, width of laneway may limit construction	500	1 500	17–51	Merri
<b>Total cost</b>					<b>377–1 100</b>	

\* Loads were estimated using a decision support system model for gross pollutant trapping systems (Allison et al. 1998b).

\*\* Costs vary depending on the type of in-line trap selected.

**Table A1 Example of recommended priorities for installing in-line litter traps (Moreland City Council 1998).**

## Appendix B: Sizing of sediment settling basins

In addition to length:width ratios, there are two parameters that need to be sized for a sediment basin;

- the basin's surface area; and
- the basin's depth.

### Settling basin surface area

The surface area is commonly sized on the basis of settling theory. The settling velocity of discrete particles under ideal settling conditions (Class I settling) is presented in Table B1.

Classification of particle size range	Particle diameter (micrometres)	Settling velocity (millimetres per second)
Very coarse sand	2000	200
Coarse sand	1000	100
Medium sand	500	53
Fine sand	250	26
Very fine sand	125	11
Coarse silt	62	2.6
Medium silt	31	0.66
Fine silt	16	0.18
Very fine silt	8	0.04
Clay	4	0.011

**Table B1 Settling velocities under ideal conditions (after Maryland Department of the Environment 1987).**

In practice however, ideal settling conditions rarely occur. This is because of many factors including:

- **sediment concentration variability:** particles interfere with the settling of others;
- **sediment shape variability:** non-spherical particles settle slower than others;
- **sediment size variability:** the settling of larger particles can cause currents, which can inhibit the settling of finer particles. Conversely, smaller particles effectively increase the fluid density, inhibiting larger particle settling;
- **particle densities:** these vary according to geology and organic matter content;
- **turbulence:** turbulence and non-uniform flow distribution can resuspend sediments; and
- **flocculation and coagulation:** this can occur during inter-event periods and increase the removal of finer particles.

Consequently, the settling velocities that can be expected within sediment basins will be lower than those predicted by ideal settling models. Barnes et al. (1981) noted that

the design of sediment settling tanks for wastewater treatment could incorporate a factor of safety, based on an assumption that the settling velocities will be 40 to 60 per cent of theoretical values. However, Ontario Ministry of Environment and Energy (OMEE) (1994), using data collected in the Nationwide Urban Run-off Program (US EPA 1983, 1986), estimated that settling velocities in stormwater can be as low as 2 per cent of theoretical values.

Because of the difficulties in estimating site specific settling velocities, designs could be based on ideal settling characteristics, with recognition of the lower velocities that will occur in reality. These can be expected to result in lower trapping efficiencies for the design particle during design storms. However, during flows that are lower than the design storm, finer particles would be expected to be trapped (Whytecross et al. 1989).

Under constant flow conditions settling theory suggests that (Barnes et al. 1981):

$$v_s = \frac{Q}{A}$$

where:

$v_s$  = settling velocity of target sediment (m/s)

$Q$  = flow rate (m<sup>3</sup>/s)

$A$  = surface area of the sediment basin (m<sup>2</sup>)

Therefore, for an ideal sedimentation basin, the smallest particle that will be retained has a settling velocity of  $Q/A$ . This ratio is also known as the 'overflow rate' or 'surface loading rate'. This equation can be rearranged to determine the theoretical length of the sediment basin:

$$L = \left( \frac{rQ}{v_s} \right)^{0.5}$$

where:

$L$  = basin length (metres)

$r$  = length:width ratio of the basin

To minimise short circuiting, length:width ratios should exceed 2:1 to 3:1 for sediment traps (OMEE 1994; Willing and Partners 1992b). This sizing technique assumes that the flow rate remains constant during the settling period and that water discharges from the sediment basin across the full downstream cross-section. This is often not the case, with water leaving the sedimentation basin via overflow of a weir structure at the downstream end.

A modification to the conventional design equation was proposed by Wong et al. (1999) to allow sizing of sedimentation basins which may have a permanent pool and a weir

outlet structure. The equation also incorporates provision for turbulence and short circuiting of flow paths, i.e.

$$R = 1 - \left( 1 + \frac{V_s [S_p + S_e]}{Q d_e} \right)^{-n}$$

where:

$R$  = the proportion of the target particle size retained

$n$  = a factor to account for general hydraulic inefficiency of the sedimentation basin;  $n = 1$  for poor hydraulic efficiency;  $n = 3$  for good hydraulic efficiency,  $n = 5$  for very good hydraulic efficiency; and  $n = \text{infinity}$  for ideal conditions

$S_p$  = the storage volume of the permanent pool

$S_e$  = extended detention storage respectively

$d_e$  = the depth range of the extended detention storage

Overall, there are many limitations with current design techniques for sediment basin sizing, mainly because of non-ideal settling characteristics and dynamic flow conditions.

### Settling basin depth

The risk of sediment resuspension and the desired maintenance frequency for cleaning are the two main factors which determine the depth of a sediment basin.

The most common technique for estimating scouring velocities for particular particle sizes is based on channel erosion studies (Camp 1946, cited in Metcalf and Eddy 1991). Table A2 presents estimates of the velocities that will initiate scour for various particle sizes (derived using averaged values for the erosion equation constants suggested by Metcalf and Eddy 1991).

Particle diameter (micrometres)	Scouring velocity (metres per second)
2000	0.72
1000	0.51
500	0.36
250	0.25
125	0.18
62	0.13
31	0.09
16	0.06

**Table B2 Estimated scouring velocities (after Metcalf and Eddy 1991).**

These scouring velocities can be used to estimate the basin depth required to avoid re-suspension of the design particle size during the design storm. Some scouring is

probably inevitable at the inlet to the basin, due to the jet action of the inflows, although this can be minimised by incorporating appropriate energy dissipation in the design.

Assessment of the scouring velocity could be based on the cross-section averaged velocity corresponding to the outflow discharge. The depth for this calculation could be based on the depth of water in the basin and the flow depth above this level. An estimate of the flow depth can be made assuming broad crested weir flow occurs at the downstream end of the trap. An appropriate weir flow coefficient would need to be adopted (e.g. 1.5) and any submergent effects included. Submergent effects only become significant when the downstream water depth is greater than about 90 per cent of the upstream depth (Bradley 1978).

The depth of the sediment retained in the basin will be related to the inflow sediment characteristics and the frequency of maintenance. These are difficult parameters to estimate, particularly given the limited comprehensive monitoring of sediment export (particularly bed-load) for urban catchments and sediment trap performance. Furthermore, sediment deposition within traps tends to be non-uniform.

An allowance for sediment storage of at least an additional 30 to 50 per cent of the basin depth estimated by the scouring velocity technique should be provided.

### **Construction considerations**

Durable, strong, rust-free materials should be used. These are usually concrete, but may be other materials such as masonry brick walls, gabions and reno mattresses. Reinforced concrete is durable, strong and low maintenance, but has a high construction cost and unattractive appearance. Masonry brick walls are cheaper than reinforced concrete, but are also unattractive. Gabions and reno mattresses are cheaper than reinforced concrete and provide a slightly more pleasing structure. However, litter and organic matter can become trapped in the mesh, stones can be removed from gabions by children and the public, and the structure is susceptible to damage during maintenance.

### **Maintenance considerations**

The following issues can be considered for maintenance:

- access: vehicular access to sediment trap for sediment removal;
- sediment removal: concrete or hard stand base to allow ease of removal of debris and sediment;
- silt drying: silt drying area may be required to drain removed material;
- trap de-watering: the design can provide for de-watering of the trap, with discharge to an adjacent sewerage system. If this is not feasible, a tanker may be required to transport the sediment-laden water from the site for approved disposal. If the drainage of a trap is to the sewer, then the liquid contents only of a trap can be discharged; and

- filter medium replacement: traps capable of gravity drainage to a dry condition can have filtering medium replaced if ponding occurs.

### **Safety considerations**

These include:

- safety barriers: railings or vegetation can be placed on either side of a major trap to discourage the public from approaching the sides of the trap. If railings or low fences are to be constructed, they should be aligned parallel to the direction of flow during floods, to reduce their impact on flood levels;
- slope: the slope of any side batter to the side walls of a major trap should not exceed 1(V):4(H) and should preferably be 1(V):6(H) to 1(V):8(H);
- signage: signs to discourage entry into the trap; and
- other considerations.

The visual impact of a trap can be improved by landscaping, mounding and selection of construction materials. Vegetation will also prevent easy entry to the structure. If the trap location prevents its disguise by vegetative means, the use of local rock may be appropriate. The structure may also be made with coloured concrete and shaped to resemble the local rock.

## **Appendix C: Sizing of filter strips and grass swales**

---

### **Filter strip design**

Horner et al. (1994) outline a technique for sizing filter strips and grass swales based on results of studies conducted in Seattle, USA. These studies indicate that optimum pollutant retention occurs when the hydraulic residence time along the filter strip is approximately nine minutes. Performance was found to noticeably deteriorate when the residence time fell below five minutes. In addition to a hydraulic residence time of nine minutes, other basic design criteria suggested by Horner et al. (1994) for filter strips include:

- design flow velocity of less than 0.3 m/s
- design flow depth not to exceed 12 mm

Horner et al. (1994) suggest the following seven steps to design a filter strip:

- 1 Estimate the design flow for the design storm event.
- 2 Determine the slope of the filter strip.

- 3 Set the design flow depth (to be less than 12 mm).
- 4 Solve Manning's equation to determine the required width of flow. Manning's 'n' values suggested are as follows:
  - 0.20 for mowed filter strips; and
  - 0.24 for natural grasses or infrequently mowed strips.
- 5 Determine the flow area, based on the calculated flow width and established depth.
- 6 Calculate the resulting velocity. Reduce the flow, increase the flow width or reduce the depth of flow if the velocity exceeds 0.3 m/s.
- 7 Using the resulting velocity, calculate the flow length to achieve a residence time in the filter strip of nine minutes. An absolute minimum residence time should be five minutes.

One critical design element of filter strips is to maintain sheet flow over the length of the filter strip. Grass filter strip performance has been found to reduce if they are located on grades exceeding 5 per cent, particularly if the slope exceeds approximately 15 per cent with the formation of rills and high erosion potential. In these steep conditions check dams, and note that benches are needed at regular intervals to spread the flow.

Filter strips that are flatter than 2 per cent can be susceptible to water ponding and a sub-soil drainage system should be considered to ensure effective infiltration.

The slope of the filter strip should be uniform and the cross-section, level. Particular attention should be paid to this during construction.

The integrity of the filter strip may be impaired if flows greater than the design event enter the strip. Velocities exceeding the design velocity can be expected to result in reduced strip pollutant removal efficiency until the grass has recovered. Such flows may also result in scouring of the strip. A by-pass for high flows could be installed.

The depth to groundwater should be considered when designing a filter strip. If the water table is shallow, the grass species will need to tolerate this situation. Further, a shallow soil depth for pollutant retention presents a possible risk of pollution entering the groundwater.

### **Grass swale design**

Basic design guidelines for grass swales include:

- geometry: minimise sharp corners using parabolic or trapezoidal shapes and side slopes no steeper than 3:1 (h:v);

- longitudinal slope: keep slopes between 2 per cent and 4 per cent to promote uniform flow conditions across the cross section of the channel. Check dams should be installed if slopes exceed 4 per cent and underdrains installed if slopes are less than 2 per cent;
- swale width: should not exceed 2.5 m, unless structural measures are used to ensure uniform spread of flow and should be level;
- maximum flow velocity: keep below 0.5 m/s for the 1 year ARI event and a maximum velocity of 1.0 m/s for the 100 year ARI event; and
- Mannings 'n' value: adopt a Manning's 'n' value of between 0.15 and 0.2 for flow conditions where the depth of flow is below the height of the vegetation. For the 100 year event, the Manning's n value will be lower and can be assumed to be 0.03.

Horner et al. (1994) recommended a maximum depth of flow to be one third of the grass height in infrequently mowed swales and half the grass height, to a maximum of 75 millimetres, in regularly mowed swales. Greater flow depths would be appropriate in grassed waterways designed to convey floodwaters (for example 100 year ARI).

The integrity of the swale may be impaired if flows greater than the design event enter the swale. Velocities exceeding the design velocity can be expected to result in reduced swale pollutant removal efficiency until the grass has recovered. Such flows may also result in scouring of the swale. A by-pass for high flows could be installed to prevent large concentrated flows eroding the swale.

The depth to groundwater should be considered when designing a swale. If the water table is shallow, the grass species will need to tolerate this situation. Further, a shallow soil depth for pollutant retention presents a possible risk of pollution entering the groundwater.

## **Appendix D: Design guide for infiltration trenches**

---

### **Trench site selection**

Site selection criteria have been developed in the USA for choosing potentially suitable sites for infiltration trenches. Horner et al. (1994) present the following site selection criteria, which aim to reduce the potential for failure, minimise groundwater pollution and achieve water quality improvement:

- the bed should be at least 1.0 to 1.5 metres above the seasonal high water table, bed-rock or a relatively impermeable layer;
- the percolation rate should be at least 0.8 to 1.3 millimetres per hour;



- the soil should have not more than 30 per cent clay or 40 per cent clay and silt combined;
- when the facility drains to groundwater, the maximum infiltration rate should not exceed 60 millimetres per hour;
- generally, only loams, sandy loams and loamy sands are suitable for infiltration trenches;
- trenches should not be constructed on fill material or on a slope exceeding 15 per cent; and
- baseflows should not enter the trench.

Camp Dresser and McKee (CDM) (1993) suggests a point system for evaluating potential infiltration sites, which is presented in Table D1. A site that obtains fewer than 20 points is considered unsuitable, while a site earning more than 30 points is considered excellent. Argue (1995) has developed site selection criteria for Australian conditions.

Item	Condition	Points
Ratio between the Directly Connected Impervious Area (DCIA) and the Infiltration Area (IA)	▪ IA > 2 DCIA	20
	▪ DCIA < IA < 2 DCIA	10
	▪ 0.5 DCIA < IA < DCIA	5
Nature of the surface soil layer	▪ Coarse soil and low organic material fraction	7
	▪ Normal humus soil	5
	▪ Fine grained soils and high organic matter fraction	0
Underlying soils (if finer than surface soils, otherwise use surface soils classification)	▪ Gravel or sand	7
	▪ Silty sand or loam	5
	▪ Fine silt or clay	0
Slope of the infiltration surface	▪ S < 7%	5
	▪ 7% < S < 20%	3
	▪ S > 20%	0
Catchment vegetation cover	▪ Healthy natural vegetation	5
	▪ Well established lawn	3
	▪ New lawn	0
	▪ No vegetation (bare soil)	-5
Degree of traffic on infiltration surface	▪ Little foot traffic	5
	▪ Average foot traffic (e.g. park, lawn)	3
	▪ Considerable foot traffic (e.g. playing fields)	0

**Table D1 Point system for evaluating infiltration sites (Source: CDM 1993).**

### Trench sizing

The pollutant retention achieved by an infiltration trench is a function of the amount of run-off captured and infiltrated to the soil. The greater the percentage of the annual run-off captured, the higher the long term removal rates.

There are currently no techniques available for predicting the pollutant retention offered by an infiltration trench. Trench performance is dependent on the underlying

soil permeability, grading and geochemistry, in addition to the infiltration rate (i.e. the amount of time that run-off is in contact with the soil).

The sizing of an infiltration trench could be based on infiltrating an expected percentage of the mean annual run-off from the catchment or a design storm event, with high flows exceeding the design storm designed to by-pass the trench. Continuous simulations of infiltration systems using rainfall data for all capital cities in Australia were undertaken by Argue (1999) to develop design curves for infiltration systems. These curves represent the relationship between the soil hydraulic conductivity, the size of the infiltration system and the percentage of mean annual stormwater run-off infiltrated into the system.

There are two simplified techniques commonly used for sizing an infiltration trench and they involve the use of maximum allowable drain time and flow rate through porous media design criteria.

The first and relatively simple technique (CDM 1993; Auckland Regional Council 1992; OMEE 1994) estimates the base area of the infiltration trench according to:

$$A = \frac{V}{d}$$

where:

$A$  = area of infiltration surface (square metres)

$V$  = effective volume of infiltration trench (cubic metres)

$d$  = depth of trench (metres)

The effective volume of the trench ( $V$ ) is the design storm run-off volume less the volume of rock within the trench (this commonly occupies 30 to 40 per cent of the trench volume).

The depth of the trench can be estimated from:

$$d = \frac{It}{S}$$

where

$I$  = infiltration rate (metres per hour)

$t$  = infiltration time (hour)

$S$  = factor of safety

Due to the difficulty in obtaining reliable percolation rate estimates, the Washington State Department of Ecology (1993) recommends making several site measurements then adopting the lower value, in addition to adopting a factor of safety of two.

More accurate and comprehensive field measurements could result in a lowering of this factor of safety. Estimates of the infiltration rate can be obtained from soils texts, based on soil textural classes. If this approach is taken, a higher factor of safety would be appropriate.

The choice of an infiltration period is related to the inter-event period and the need to minimise anaerobic conditions in the underlying soil (during warmer periods, these encourage the growth of algae which may clog the soil). Reducing the infiltration time results in a smaller volume but higher surface area for a given soil type. Pollutant removal is enhanced by increasing the surface area of the bottom of the trench, which also reduces the risk of clogging.

Infiltration periods of 24 to 72 hours have been recommended by CDM (1993) and Schueler (1987), with the lower periods applying when the inter-storm period in the wet season is relatively short. Auckland Regional Council (ARC) (1992) adopts an infiltration period for the mean storm of at least 50 per cent of the mean inter-storm period. As the majority of the infiltration occurs during the inter-event period, an approximate infiltration period could be determined from an analysis of the site's rainfall data history. Similar criteria to those of ARC (1992) could then be applied. These analyses have been carried out for major cities in Australia by Wong et al. (1998).

The second sizing technique is that described by Horner et al. (1994). This method calculates the surface area and infiltration volume based on Darcy's law, which describes flow through porous media. This is potentially a more accurate technique, but requires more information than the simple technique described above (see Appendix F). Argue et al. (1998) have outlined a number of design procedures for sizing of infiltration trenches in Australian catchments.

### **Trench configuration**

Pre-treatment of run-off entering an infiltration trench is necessary for removing coarse particulates that can cause clogging. This pre-treatment may consist of a grass filter strip, grass swales, a sand filter or primary treatment measure.

The length and width of the trench will be determined by the site characteristics. If stormwater is conveyed to the trench as uniform sheet flow, the length of the trench perpendicular to the flow direction can be maximised. If run-off is conveyed as channel flow, the length of the trench parallel to the direction of flow can be maximised. The base of the trench should be level, to evenly distribute exfiltration.

For flows in excess of the design storm, infiltration trenches can be designed with overflow pipes. Trenches may also be designed to pond excess water above the trench for delayed infiltration.

Clean, washed stone aggregate, typically 25 to 75 millimetres diameter, can be used as fill. Increasing the diameter of the stone will increase the effective volume of the trench. A sand layer or geotextile fabric can be placed at the base of the trench to prevent upward piping of underlying soils. The sides of the trench can be lined with a geotextile fabric to prevent migration of soil into the rock media. To minimise migration of soil particles, filter fabric can extend to cover the top of the trench if (porous) topsoil is used.

An observation well can be installed through the media to permit trench water level monitoring.

### **Alternative infiltration trenches**

#### *Dry wells*

Known as dry wells, small infiltration trenches can be designed to drain small areas (e.g. to capture roof run-off). These wells are suitable for use either with small individual commercial buildings or single family residences and rarely include pre-treatment. Roof run-off is delivered via a downpipe into the upper portion of the stone reservoir. The stone reservoir may be located about 300 millimetres below the ground surface and can include an observation well for routine inspection. Run-off exceeding infiltration capacity is discharged to the surface via an overflow pipe located within the downpipe.

#### *Pervious pipes*

These systems comprise a pipe network that is perforated along its length, allowing exfiltration of water through the pipe wall as it is conveyed downstream. Pre-treatment to remove coarse sediment is appropriate to prevent blocking of the perforations. To promote exfiltration, pervious pipe systems can be implemented with reasonably flat slopes (0.5 per cent). Double pipe systems can be used, comprising a regular drain pipe over a perforated pipe. This is more expensive, but provides a contingency conveyance system if the perforated pipe becomes clogged. In addition, the perforated pipe can be plugged during the construction phase until the site has stabilised.

### **Trench construction considerations**

Prior to development of the site, the proposed infiltration trench area should be fenced off to prevent heavy equipment compacting underlying soils. To increase infiltration, the base of the trench should be ripped prior to placing the rock fill. Compaction of the base of the trench should not be performed. Clean rock fill only should be used. Infiltration tests on the base of the trench should be carried out prior to the placement of the rock fill.

During the construction phase, sediment and run-off should be diverted away from the trench area to minimise the potential for blocking the trench. Operation of the trench should not commence until the catchment has stabilised.

## Appendix E: Design guide for extended detention basins

---

### Basin outlet design

The proper design of an extended detention basin outlet is critical to its performance. Fundamental to its optimum operation are the hydraulic characteristics of the outlet structure.

Potential outlet types include:

- weir: this is a common outlet structure but often does not provide adequate hydraulic control over the full depth range of the extended detention storage, owing to its efficient discharge characteristics. Extended detention systems controlled by a weir outlet often have very low depth fluctuation for most of the storm events, with the desired detention period only provide for the design storm event. Difficulties can be experienced achieving low release rates at low heads, even with the use of a V-notch weir. An alternative is a proportional discharge weir.
- perforated riser: this outlet structure consists of vertical riser pipe with small orifices located along its length. Gravel can be placed around the riser pipe to act as a filter but special care will need to be taken to prevent blockage of the orifices. Inverted pipe elbows are commonly used to alleviate this problem. Risers promote the narrowest range of detention period for a wide range of stormwater inflow characteristics. Risers can be designed to match the stage-storage relationship of the extended detention basin, so a near-linear storage-discharge relationship is achieved. Such characteristics would ensure that there is a consistent period of stormwater detention in the system regardless of the size of the inflow event.
- culverts and reverse slope pipe: culvert outlets are common in extended detention systems such as flood retarding basins and water quality detention ponds. Reverse slope pipes are applicable where there is a deep pool located at the outlet of the basin and have similar hydraulic characteristics (especially under design conditions) to conventional culverts. The reverse sloped pipe can be used to draw water from below the surface of the pool, thereby avoiding floating materials in the basin. This is particularly useful where blockages from floating material may be a problem. A gate valve may also be installed in the reverse slope pipe to allow the drawdown time to be modified to improve pollutant removal.

Further details on outlets are provided in Schueler (1987), OMEE (1994), and Somes and Wong (1998).

The sizing of the basin for a single design event does not guarantee that adequate residence time will be achieved for all events—smaller events may pass through the basin in a period too short for effective treatment. Stage or depth to discharge relationships of the outlet structure define the distribution of detention period over the operating life of the

detention basin. The stage-discharge relationships for the outlet structures can be established using conventional hydraulic equations for weir flow and orifice/culvert flow.

If sizing the extended detention basin is to be based on the adoption of a design storm, it will be necessary to examine the operation of the storm for a number of storm durations to define the critical storm duration corresponding to the design average recurrence interval. The equation for the adopted outlet type can be specified in a rainfall run-off model of the basin, which also includes a stage-storage volume relationship. The design storm events are then routed through the storage to determine the storage requirement and residence time.

The use of a culvert is common practice in extended detention systems. An approximate technique for sizing the outlet (cited in CDM 1993) can be applied when side slopes of the basin are uniform and an orifice outlet is used. The equation is based on the drawdown time of a falling head orifice:

$$a = \frac{2A(\Delta h)^{0.5}}{3600ct(2g)^{0.5}}$$

where

$a$  = area of orifice (square metres)

$A$  = average surface area of pond (square metres)

$\Delta h$  = difference between full and empty levels (metres)

$c$  = discharge coefficient (normally between 0.67 and 0.80)

$t$  = draw down time (hours)

$g$  = gravitational acceleration constant (9.81 metres per second<sup>2</sup>)

If the residence time for small events is found to be inadequate, the hydraulic characteristics of the outlet structure can be modified (e.g. adoption of a riser outlet structure) or a two-stage outlet used. This can involve incorporating a second culvert at the half-basin height. The lower culvert can be designed to drain half the basin in 24 hours, while the combined capacity of the two culverts is designed to drain the entire basin in 40 hours.

The design of risers uses the same hydraulic equations as that for culverts. The establishment of the stage-discharge relationship for the riser, however, will need to integrate the respective discharges of the orifices along the vertical length of the riser pipe at every stage increment. Wong et al. (1999) provide an empirical relationship for selecting the orifice area for a riser to promote near linear storage-discharge relationship. This was based on fitting a curve of best fit to a height-discharge relationship derived theoretically for a riser with orifices placed at 250 mm interval and is:

$$Q = c_d A_{0.25} \sqrt{2g} (1.07y^2 + 2.05y + 0.036)$$

where

$c_d$  is the orifice discharge coefficient (~0.67)

$A_{0.25}$  is the area of the orifice to be placed at 0.25 m interval along the riser

$g$  acceleration due to gravity (i.e. 9.81 m/s<sup>2</sup>)

### **Basin geometry and layout**

Sedimentation is the primary pollutant removal process in extended detention basins.

There are a number of features that should be considered during the design:

- effective residence time: it is important that the inflow volume is uniformly distributed within the basin volume and short circuiting is minimised. This can be achieved by a basin length to width ratio of between 3:1 and 5:1. The inlet to the basin should also generally be located as far from the basin outlet as possible. To increase the length to width ratio or overcome problems with the inlet being too close to the outlet, berming may be included to redirect flows.
- velocity distribution: sedimentation will be enhanced by low flow velocities and avoiding strong flow jets at the inlet to the basin. These can be minimised by installing energy dissipators at the inlets.
- depth: the sedimentation process will also be enhanced by a relatively shallow depth, which reduces the distance for settling particles to fall. An average depth of 1–2 metres may be appropriate.
- off-line basin: by-passing high flows above the design storm flow can reduce the possibility of scouring. Alternatively, flood storage could be provided above the permanent water storage, which will reduce flow velocities through the basin.
- stabilised low flow path: to minimise scouring during frequent events.
- grassing of the basin floor: this helps filter the sediment and assists in binding sediment to the basin floor.

Other aspects of the basin geometry include:

- side slopes: for grassed basins, the basin side slopes should be designed to meet safety and maintenance requirements. Maximum slopes of 8:1 may be appropriate. Steeper side slopes may be used in ungrassed areas, for example where retaining walls or shrub beds are used and are provided with safety fences.
- basin floor: the basin floor should be designed to drain freely. A slope steeper than 1 to 2 per cent is suggested. Flat slopes can result in difficulties with grass mowing and

mosquito breeding. Grass species planted on the basin floor should be tolerant of frequent inundation. Subsoil drains may be provided to address this problem.

- groundwater: depth to groundwater should be considered during the design. If the water table is high, problems may be experienced with grass mowing—the grass species may need to be tolerant of the groundwater chemistry.
- access: vehicular access for maintenance should be provided.
- downstream outlet: an energy dissipator should be considered at the downstream end of the outlet pipe from the basin, to minimise erosion of downstream waterways.

## Appendix F: Design guide for sand filters

---

### Large sand filters

#### *Sizing*

There are two key components to be sized for large sand filters, namely:

- the upstream settling (or pre-treatment) basin; and
- the filter.

These components can be designed on the basis of a design storm event or using design curves based on continuous simulations techniques such as that developed for infiltration systems by Argue (1999). High flows in excess of the design storm can be designed to by-pass the filter.

The upstream settling basin should be designed for a removal efficiency that avoids rapid clogging of the filter. The approach suggested by CDM (1993) is an extended detention basin based on achieving suspended solid retention of 60 to 75 per cent during a design storm and a drawdown time of 24 hours. A perforated riser pipe can be used as the outlet for the basin, as described in Section 7.8 (Secondary treatment Type No. 6: Extended detention basins).

ARC (1992) recommends a settling basin with a permanent pool. This pool can be sized to achieve the same retention as the extended detention settling basin, using settling velocity theory or the retention curves contained in Section 7.9 (Constructed wetlands).

The surface area of the filter can be derived from the following equation (after ARC 1992):

$$A = \frac{V_w}{Kt(h + D)}$$

where

$A$  = area of filter (square metres)



$V$  = volume to be infiltrated (cubic metres)

$K$  = hydraulic conductivity (metres per hour)

$t$  = drainage time (hours)

$h$  = average head above filter (half the storage depth—metres)

$w$  = thickness of the filter layer (metres)

$D$  = depth of filter (metres)

ARC (1992) recommends a hydraulic conductivity of 0.033 metres per hour, which corresponds to a system with partial and full pre-treatment (City of Austin 1988). This value is less than the typical conductivity of new sand media and hence allows for some clogging.

A minimum media depth of 0.4 metres is recommended by ARC (1992). A filtration time of 24 hours is recommended by CDM (1993) and City of Austin (1988). ARC (1992) recommends a filtration period determined according to rainfall patterns at the proposed site—a 16 hour period was used, corresponding to one third of the mean inter-event period. This approach was adopted so that the filter has a dry period between events, to maintain aerobic conditions and hence long term infiltration capability.

### *Geometry*

Other characteristics of the settling basin that can enhance efficiency include (CDM 1993; City of Austin 1988; ARC 1992):

- energy dissipation at the inlet;
- minimise flow velocities to prevent resuspension (e.g. less than 0.3 metres per second);
- effective use of storage volume, that is, minimising short circuiting. A length to width ratio of at least 5:1 could be adopted;
- access for maintenance; and
- trash rack at the settling basin outlet.

Characteristics of the filter that optimise efficiency include (CDM 1993; City of Austin 1988; ARC 1992):

- use of a flow spreader to achieve a uniform flow distribution over the filter. A saw-tooth weir may be used for this purpose; and
- a geotextile fabric over a coarse gravel layer above the under-drain.

CDM (1993) adopts a sand size of between 0.5 and 1.0 millimetres, while the City of Austin (1988) uses sand sized at 0.25 to 0.5 millimetres. ARC (1992) recommends 10 per cent of sand should pass a 63 micrometre sieve and 90 per cent should pass a 500 micrometre sieve.

### **Small sand filters**

#### *Sizing*

Two key components need to be sized for small sand filters; the upstream sedimentation chamber and the filter.

These components can be designed on the basis of a design storm event or using design curves based on continuous simulation techniques, such as that developed for infiltration systems by Argue (1998). High flows in excess of the design storm can be designed to by-pass the filter. The sedimentation chamber can be designed using sediment basin sizing techniques described in Appendix B and the filter designed using the technique described in Appendix C.

#### *Geometry*

Shaver (1996) recommends a number of points for small sand filter geometry. These include:

- run-off should enter the sand filter by overland flow or gutter flow;
- a grated cover should be provided over the sedimentation chamber;
- a weir should be fitted between the sedimentation chamber and the filter to obtain sheet flow over the filter (the sediment chamber should have no outlets other than the overflow to the filter);
- a minimum depth of sand in the filter of 450 millimetres;
- a minimum distance of 150 millimetres between the top of the outflow pipe and the top of the sand filter. For a 450 millimetre deep filter, this equates to a maximum outlet pipe diameter of 300 millimetres. Multiple outlet pipes may be used if required;
- a screen covered with filter fabric should be installed at the outlet pipe to prevent loss of sand from the filter; and
- a maximum sand particle size of two millimetres.

## **Appendix G: Derivation of constructed wetland sizing technique**

---

The wetland system sizing technique presented in Section 6.9 of this document is an extension of the work undertaken by Duncan (1997b) at the Cooperative Research Centre

for Catchment Hydrology (CRCCH) on the pollutant removal efficiency of ponds and wetlands. The original work by Duncan (1997b) investigated the relationship between a range of factors and the pollutant output percentage. This is the ratio of the outflow to inflow event mean concentration of a pond/wetland, expressed as a percentage. The factors included in the analysis were:

- area ratio: the ratio of the surface area of the wetland to the wetland's catchment area;
- inflow concentration: concentration of the pollutant in the inflow to the wetland; and
- storage depth: the ratio of the wetland's volume to its catchment area.

A total of eighty-eight Australian and overseas studies were collected by the CRCCH for use in this analysis (Duncan 1997a).

A review was undertaken of all studies before their inclusion in the analysis, to assess both the design of the pond or wetland against 'good practice' and the quality of the monitoring data. Consequently, a weighted scoring system was developed for evaluating the quality of both the pond/wetland design and the sampling data used to evaluate the performance of the pond/wetland. This approach was adopted to avoid biasing the overall results with the incorporation of data from poorly monitored studies or poorly designed ponds/wetlands. Each study was rated according to:

- a design index: a measure of the design of the pond/wetland against factors considered to represent 'good design practice'; and
- a data index: a measure of the quality of the monitoring data.

The design index is presented in Table G1 and is based on allocating high scores to factors likely to enhance performance. The use of the design index was considered to provide a reasonable basis for combining the pond and wetland data. This increased the number of studies available for analysis, by effectively eliminating poorly designed ponds, which are unlikely to reflect the expected performance from constructed wetlands.

The data index is presented in Table G2 and is weighted towards the factors that are most important in achieving an accurate determination of the pond or wetland's long-term performance.

Only those studies with a design index greater than 1 and a data index greater than 16 were included in the subsequent analysis. Further, ponds/wetlands with considerably smaller area ratios than those expected in constructed wetland design (less than 0.1 per cent) were also excluded from the analysis to avoid biasing the resulting regression. The design index was not found to be a statistically significant explanatory variable for output of suspended solids (SS), so sites with low design index scores were therefore included in the analysis for this variable. The resulting studies used in the analysis are noted in Table G3.

Factor	Condition	Score
Shape	▪ Length:width ratio > 3	1
	▪ Intermediate or unknown	0
	▪ Length:width ratio < 2	-1
Multiple cells	▪ Single cell	-1
	▪ Unknown	0
	▪ Multiple cells	1
Permanent pool	▪ Dry basin	-1
	▪ Extended detention basin or unknown	0
	▪ Permanent pool	1
Mixed use	▪ Flow passes through a pond then a wetland	1
	▪ Single pond/wetland or unknown	0
Depth	▪ Mean depth < 1 metre	1
	▪ Intermediate depth or unknown	0
	▪ Mean depth > 2 metres	-1
Potential score range		-4 to 5

**Table G1 Design index.**

Factor	Condition	Score
Event-based monitoring	▪ Yes	5
	▪ No or unknown	1
Flow weighted monitoring	▪ Yes	5
	▪ No or unknown	1
Monitoring duration	▪ Duration > 6 months	3
	▪ Duration 2–6 months	2
	▪ Duration < 2 months	1
	▪ Unknown	*
Number of events	▪ Number > 10	6
	▪ Number 6–10	
	▪ Number < 6	
	▪ Unknown	
Land-use	▪ Urban > 75 per cent	2
	▪ Urban 50–75 per cent	1
	▪ Urban < 50 per cent	0
Potential score range		4 to 21
* same rank score as that given for event-based monitoring		
** same rank score as that given for monitoring period		

**Table G2 Data index.**

Regression analyses were undertaken between the output percentage of each pollutant and the following explanatory variables:

- area ratio: pond/wetland area as a percentage of catchment area;
- storage: ratio of pond's or wetland's volume to its catchment area;
- average annual hydraulic residence time: the ratio of the pond/wetland volume and the estimated annual run-off volume;
- hydraulic loading rate: the ratio of the estimated average annual run-off volume and the surface area of the pond/wetland (also known as the upflow or overflow rate); and
- inflow concentration.

Site	Location	Parameters available			Reference
		SS <sup>*</sup>	TP <sup>†</sup>	TN <sup>‡</sup>	
Crookes Wetland	Albury		▪	▪	Raisin and Mitchell (1995)
Lake Ridge	Minnesota, USA		▪	▪	Oberts et al. (1989)
DUST Marsh (3)	California, USA		▪		Meiorin (1989)
Whispering Heights	Seattle, USA	▪			Dally (1984)
Carver Ravine	Minnesota, USA		▪	▪	Oberts et al. (1989)
Orlando Pond	Florida, USA	▪			Martin and Miller (1987)
Montgomery Basin	Maryland, USA	▪			Grizzard et al. (1986)
McCarrons (3)	Minnesota, USA		▪	▪	Wotzka and Obert (1988)
Bellevue 31	Seattle, USA	▪			Reinhelt and Horner (1985)
Lake Annan	Campbelltown	▪			SKM (1996)
The Paddocks	Adelaide	▪	▪	▪	Tomlinson et al. (1993)
Greenview (2)	Florida, USA	▪			Yousef et al. (1990)
Waverly Hills	Michigan, USA	▪			Athayde et al. (1983)
Lake Ellyn	Illinois, USA	▪			Athayde et al. (1983)
Unqua Pond	New York	▪			Athayde et al. (1983)
Orlando Wetland	Florida, USA	▪			Martin and Miller (1987)
Stedwick	Washington DC, USA	▪			Athayde et al. (1983)
Hidden Lake	Florida, USA	▪			Harper et al. (1986)
Hayman Park	Auckland, NZ		▪		Leersnyder (1993)
Frisco Lake	Missouri, USA	▪			Oliver and Grigoropoulos (1981)
Springhill	Florida, USA	▪			Holler (1989)
Orlando Ponds	Florida, USA	▪	▪		Harper (1988)
Pacific Steel	Auckland, NZ	▪	▪		Leersnyder (1993)
Westleigh	Washington DC, USA	▪			Athayde et al. (1983)
Orlando Highway	Florida, USA	▪	▪	▪	Harper (1988)
Wayzata	Minnesota, USA	▪	▪		Hickock et al. (1977)
Orlando Pond	Florida, USA	▪			Harper (1988)

SS<sup>\*</sup> = suspended solids    TP<sup>†</sup> = total phosphorous    TN<sup>‡</sup> = total nitrogen

**Table G3 Studies used in regression analysis.**

The original investigation by Duncan (1997b) showed that the relationships were strongest when the analysis was undertaken on log-transformed data (i.e. a log-domain analysis) for both axes. This approach was therefore adopted for this analysis.

The analysis results indicated that the inflow concentration was a statistically significant variable (at the 5 per cent level) only for suspended solids. The correlation coefficients (R<sup>2</sup>) from this log<sub>10</sub>-domain analysis are indicated in Table G4. Inflow concentration did not significantly affect the output percentage of total nitrogen or total phosphorus.

The regressions are strongest for suspended solids and weakest for total nitrogen. The high variability (i.e. low predictability) in nutrient retention—particularly nitrogen—is consistent with a number of previous pond and wetland performance studies (e.g. Schueler et al. 1992).

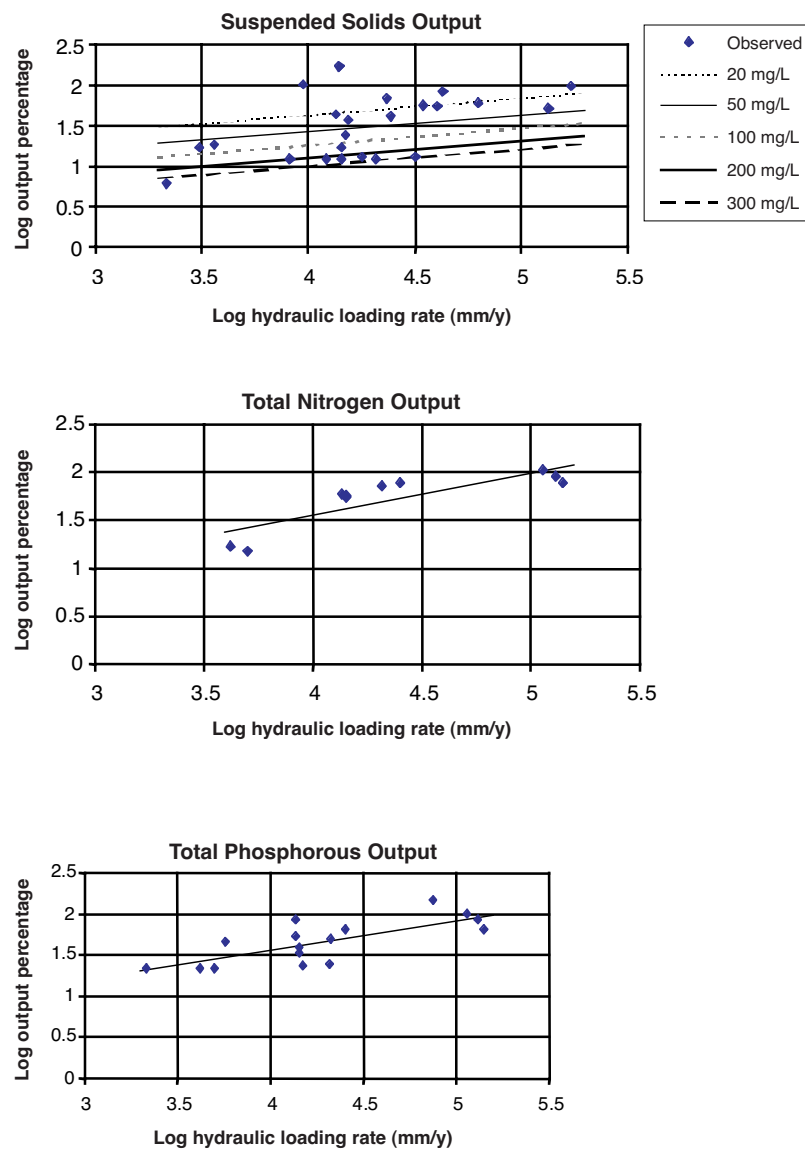
The best explanatory variable for total phosphorous (TP) and total nitrogen (TN) was hydraulic loading rate, with the correlation for this variable being only marginally lower than the best regressions for suspended solids (SS). For nutrient retention, hydraulic residence time was a considerably poorer explanatory variable than hydraulic loading rate.

Parameter	R2 for variable†:			
	Area ratio	Storage depth	Residence time	Loading rate
Suspended solids**	0.78	0.79	0.79	0.78
Total phosphorus	0.52	0.43	0.38	0.56
Total nitrogen	0.35*	0.10*	0.24*	0.69

† variables log<sub>10</sub> transformed  
 \* correlation was not statistically significant at the 5 per cent level  
 \*\* inflow concentration was also a significant explanatory variable

**Table G4 Correlations between pond/wetland performance and explanatory variables).**

The resulting regressions between log hydraulic loading rate and log output percentage are presented in Figure G1. These regressions were used to derive the pollutant retention curves presented in Figure 7.34.



**Figure G1 Pond/wetland pollutant output relationships.**

## Appendix H: Vegetation bands for wetlands

<b>Ephemeral swamp</b>
<p><b>Typical ecological characteristics</b>                      Dominant species: e.g. Eucalyptus, Melaleuca, Poa, Juncus                      Vegetation: 2 metre woodland overstorey, low-high density open-closed canopy, approximately 0.5 metres low-high density grassland-rushland groundcover</p> <p><b>Typical physical characteristics</b>                      Surface area:volume ratio: high (when inundated)                      Water depth: ~0.1 to 0.2 metres                      Natural water regime: ephemeral (mostly dry, occasional irregular inundation cycle)</p> <p><b>Potential treatment processes and mechanisms</b>                      Solids removal: sedimentation and filtration (particularly of fine particles)                      Mineralisation: microbial growth, enhanced by wetting and drying                      Nutrient uptake and transformation: microbial and macrophyte growth                      Nutrient storage: sediment adsorption</p>
<b>Shallow marsh</b>
<p><b>Typical ecological characteristics</b>                      Dominant species: e.g. Eleocharis acuta (Common Spike-rush)                      Vegetation: 0.3 to 0.7 metres, low-medium density open canopy, typically supports epiphytic algae on submerged culms</p> <p><b>Typical physical characteristics</b>                      Surface area:volume ratio: high                      Water depth: approximately 0.1 to 0.2 metres                      Natural water regime: ephemeral (regular seasonal dry cycle)</p> <p><b>Potential treatment processes and mechanisms</b>                      Aeration: surface exchange and epiphytic photosynthesis                      Solids removal: filtration (surface adhesion)                      Mineralisation: microbial growth, enhanced by wetting and drying                      Nutrient uptake and transformation: microbial, epiphyte and macrophyte growth                      Nutrient storage: sediment adsorption</p>
<b>Marsh</b>
<p><b>Typical ecological characteristics</b>                      Dominant species: e.g. Bolboschoenus medianus (Marsh Club-rush)                      Vegetation: 0.5 to 1.5 metres high, high density closed canopy, high litter production.</p> <p><b>Typical physical characteristics</b>                      Surface area:volume ratio: medium-high                      Water depth: approximately 0.3 metres                      Natural water regime: ephemeral (occasional-regular dry cycle)</p> <p><b>Potential treatment processes and mechanisms</b>                      Solids removal: sedimentation and filtration                      Mineralisation: microbial growth                      Nutrient uptake and transformation: microbial and macrophyte growth                      Nutrient storage: sediment adsorption and litter accumulation</p>

<b>Deep marsh</b>
<p><b>Typical ecological characteristics</b>                      Dominant species: e.g. Schoenoplectus validus (River Club-rush)                      Vegetation: 1–2 metres, medium-dense, semi-closed canopy, supporting some epiphytic algae, moderate litter production</p> <p><b>Typical physical characteristics</b>                      Surface area:volume ratio: medium                      Water depth: approximately 0.4 to 0.6 metres                      Natural water regime: permanent (occasional irregular dry cycle)</p> <p><b>Potential treatment processes and mechanisms</b>                      Solids removal: sedimentation and filtration                      Mineralisation: microbial growth                      Nutrient uptake and transformation: microbial, epiphyte and macrophyte growth                      Nutrient storage: sediment adsorption and litter accumulation</p>
<b>Open water</b>
<p><b>Typical ecological characteristics</b>                      Dominant species: algae (or submerged macrophytes in low nutrient conditions)                      Vegetation: phytoplankton growth resulting in secondary solids production (macrophyte growth inhibiting mixing and removing solids by sedimentation and filtration)</p> <p><b>Typical physical characteristics</b>                      Surface area:volume ratio: low                      Water depth: 1.5 to 2.0 metres                      Natural water regime: permanent, generally well mixed, but may stratify during still conditions, particularly in the warmer months</p> <p><b>Potential treatment processes and mechanisms</b>                      Solids removal: sedimentation (and filtration)                      Aeration: wind mixing, algal photosynthesis                      Sterilisation: UV exposure                      Nutrient uptake and transformation: phytoplankton and submerged macrophyte growth                      Nutrient storage: sediment adsorption and accumulation</p>
<p>After Somes et al. (1996).</p>

## **Appendix I: State Planning Policy Framework**

### **General implementation**

#### *Catchment planning and management*

Planning authorities must have regard to relevant aspects of:

- any regional catchment strategies approved under the Catchment and Land Protection Act 1994 and any associated implementation plan or strategy, including regional vegetation plans, regional drainage plans, regional development plans, catchment action plans, landcare plans and management plans for roadsides, soil, salinity, water quality and nutrients, floodplains, heritage rivers, river frontages and waterways.
- any special area plans approved under the Catchment and Land Protection Act 1994.



Planning and responsible authorities should coordinate their activities with those of the Boards of catchment management authorities appointed under the Catchment and Land Protection Act 1994 and consider any relevant management plan or works program approved by a catchment authority.

Planning and responsible authorities should coordinate their activities with those of the Boards of catchment management authorities on downstream water quality and fresh-water, coastal and marine environments, and where possible, should encourage:

- the retention of natural drainage corridors with vegetated buffer zones at least 30 metres wide along waterways to maintain the natural drainage function, stream habitat and wildlife corridors and landscape values; to minimise erosion of stream banks and verges; and to reduce polluted run-off from adjacent land-uses.
- measures to minimise the quantity and retard the flow of stormwater run-off from developed areas.
- measures, including the preservation of floodplain or other land for wetlands and detention basins, to filter sediment and wastes from stormwater prior to its discharge into waterways.

Responsible authorities should ensure that works at or near waterways provide for the protection and enhancement of the environmental qualities of waterways, and that their instream uses and are consistent with Guidelines for Stabilising Waterways (Rural Water Commission 1991) and Environmental Guidelines for River Management Works (Department of Conservation and Environment 1990), and that they have regard to any relevant river restoration plans or waterway management works programs approved by a catchment authority.

### *Water quality protection*

Planning and responsible authorities should ensure that land-use activities potentially discharging contaminated run-off or waste to waterways are sited and managed to protect the quality of surface water and groundwater resources, rivers, streams, wetlands, estuaries and marine environments.

Incompatible land-use activities should be discouraged in areas subject to flooding, severe soil degradation, groundwater salinity or geotechnical hazards where the land cannot be sustainably managed to ensure minimum impact on downstream water quality or flow volumes.

Planning and responsible authorities should ensure land-use and development proposals minimise nutrient contributions to waterways and water bodies and the potential for the development of algal blooms, consistent with the Preliminary Nutrient Guidelines for Victorian Inland Streams (EPA 1995), the Victorian Nutrient Management Strategy

(Government of Victoria 1995) and any nutrient or water quality management plans approved by the government.

Responsible authorities should use appropriate measures to restrict sediment discharges from construction sites in accordance with construction Techniques for Sediment Pollution Control (EPA 1991) and Environmental Guidelines for Major Construction Sites (EPA 1995).

Planning and responsible authorities should utilise mapped information available from the Department of Natural Resources and Environment to identify the beneficial uses of groundwater resources and have regard to potential impacts on these resources of proposed land-use or development.

#### *General implementation*

Planning and responsible authorities should ensure that water quality in water supply catchments is protected from possible contamination by urban, industrial and agricultural land-uses.

Urban development must be provided with sewerage at the time of subdivision, or lots created by the subdivision must be capable of adequately treating and retaining all domestic wastewater within the boundaries of each lot consistent with the Code of Practice: Septic Tanks (EPA 1996) and relevant State environment protection policies.

Planning and responsible authorities should ensure that:

- planning for urban stormwater drainage systems considers the catchment context and is coordinated with adjacent municipalities;
- best environmental management practice is used where practicable in the design and management of urban stormwater drainage systems, including measures to reduce peak flows and assist screening, filtering and treatment of stormwater, to enhance flood protection and minimise impacts on water quality in receiving waters; and
- drainage systems are protected where practicable from the intrusion of litter, in accordance with strategies set out in Victoria's Litter Reduction Strategy (EPA 1995).

The re-use of wastewater including urban run-off, treated sewage effluent, and run-off from irrigated farmland should be encouraged where appropriate, consistent with the Guidelines for Wastewater Re-use (EPA 1996).

# References

---

- ACT Government, 1994, *Urban Stormwater: Standard Engineering Practices*, Edition 1, Department of Urban Services.
- Allison Partners, 1998, *Moreland City Council Litter Trap Action Plan: A Report to Moreland City Council*.
- Allison, R.A., Chiew, F.H.S. and McMahon, T.A., 1998b, *A Decision Support System for Determining Effective Trapping Strategies for Gross Pollutants*, Research Report for the Co-operative Research Centre for Catchment Hydrology.
- Allison, R.A., Wong, T.H.F. and McMahon, T.A., 1996, 'Field trials of the polluted stormwater pollution trap', *Water*, September, pp. 29–34.
- Allison, R.A., Rooney, G.R., Chiew, F.H.S. and McMahon, T.A., 1997, 'Field trials of side entry pit traps for urban stormwater pollution control', 9th National Local Government Engineering Conference, Melbourne, August.
- Allison, R.A., Walker, T.A., Chiew, F.H.S., O'Neill, I.C. and McMahon, T.A., 1998, *From Roads to Rivers: Gross Pollutant Removal From Urban Waterways*, Research Report for the Co-operative Research Centre for Catchment Hydrology.
- Auckland Regional Council (ARC), 1992, *Design Guideline Manual: Stormwater Treatment Devices*, prepared by Beca Carter Hollings and Ferner.
- Argue, J.R., 1995, 'Stormwater management in Australian residential developments: towards a common practice', *Proceedings of the 2nd International Symposium on Urban Stormwater Management*, Melbourne, Institute of Engineers, Publication No. 95/03.
- Argue, J., Geiger, W.F. and Pezzaniti, D., 1998, 'Demonstration Projects in "Source Control" Technology: Theory and Practice', *Proceedings of HydraStorm '98, 3rd International Symposium on Stormwater Management*, Adelaide, Australia, 27–30 September, pp. 419–424.
- Argue, J.R. (ed.), 1999, 'Source control stormwater management: engineering design procedures', Workshop notes, Urban Water Resources Centre, University of South Australia, Adelaide, South Australia.
- Argue, J.R., 1994, 'Stormwater source control practices for arid zone urban developments', *Proceedings of the Water Sensitive Urban Design Seminar*, Perth, Australia, September, pp. 137–161.

- Armitage, N.P., Rooseboon, A., Nel, C. and Townshend, P., in press, 'The removal of trash from stormwater conduits'.
- Armitage, N.P., Rooseboon, A., Nel, C. and Townshend, P., 1998, *The Removal of Urban Litter From Stormwater Conduits and Streams*, Report to Water Research Commission of South Africa, Report No. 95/98.
- Balmforth, D.J. and Cootes, T.F., 1991, 'Field testing of a prototype vortex combined sewer overflow with spill', in *New Technologies in Urban Drainage*, Elsevier, New York, pp. 179–192.
- Baramy Engineering, 1997, Product description, Katoomba, NSW.
- Barnes, D., Bliss, P.J., Gould, B.W. and Vallentine, H.R., 1981, *Water and Wastewater Engineering Systems*, Pitman Publishing, London.
- Beecham, S.C. and Sablatnig, S.J., 1994, 'Hydraulic Modelling of Stormwater Trashracks', *Proceedings of the International Conference on Hydraulics in Civil Engineering*, NCP 94/1, Institution of Engineers Australia, pp. 97–104.
- Bradley, J.N., 1978, *Hydraulics of Bridge Waterways*, Federal Highway Administration, Washington DC.
- Brombach, H., Xanthopoulos, C., Hahn, H.H. and Pisano, W.C., 1993, 'Experience with vortex separators for combined sewer overflow control', *Water Science and Technology*, Vol. 27, No. 5–6, pp. 93–104.
- Brownlee, R.P., 1995, 'Evaluation of effectiveness and efficiency of North Sydney Council Litter Control Program', *Proceedings of the 2nd International Symposium on Urban Stormwater Management*, Melbourne Australia, 11–13 July, Institution of Engineers, Australia, NCP 95/03, Vol. 2, pp. 413–416.
- Bryant, G., Misa, F., Weatherbe, D. and Snodgrass, W., 1995, 'Field monitoring of stormceptor performance', Chapter 2 in *Study Manual: Stormceptor*, pp. 11–24.
- Camp Dresser and McKee (CDM), 1993, *California Storm Water Best Management Practice Handbooks: Municipal*, prepared for California Stormwater Quality Task Force.
- Carleton, M.G., 1990, 'A study of trash and trash interception devices', *Water Science and Technology*, Vol. 22, pp. 287–290.
- City of Austin, 1988, *Environmental Criteria Manual*, Austin, Texas.
- Construction Industry Research and Industry Information Association (CIRIA), 1992, Report 123, *Scope for Control of Urban Runoff, Volume 1*, CIRIA Report 124, *Scope for Control of Urban Runoff, Volumes 2, 3 and 4*, Construction Industry Research and Information Association, London.
- Cooper, G., 1992, 'Hayes Street litter control pit', *Proceedings of the Design and Performance of Gross Pollutant Traps and Wet Basins Seminar*, Sydney, Institution of Engineers, Australia.
- Cordery, I., 1976, 'Some effects of urbanisation on streams', *Civil Engineering Transactions*, Institution of Engineers Australia, Vol. CE18, pp. 7–11.
- CSR Humes, 1997, Product description (In-line Litter Separator), Chatswood, NSW.
- Department of Land and Water Conservation (in press), *Constructed Wetlands Design Manual*, NSW Department of Land and Water Conservation, Sydney.

- Department of Planning, 1993, *Better Drainage: Guidelines for the Multiple Use of Drainage Systems*, NSW Department of Planning, Sydney.
- Duncan, H.P., 1997a, 'Urban stormwater treatment by storage', *Proceedings of the 24th Hydrology and Water Resources Symposium*, New Zealand Hydrological Society, Auckland, New Zealand, p. 522.
- Duncan, H.P., 1997b, *Urban Stormwater Treatment by Storage: A Statistical Overview*, Cooperative Research Centre for Catchment Hydrology Report No 97/1, Melbourne.
- EcoRecycle Victoria, 1998, *Manufacturers Waste Reduction Manual*.
- Environment Protection Authority Victoria Australia (EPA), 1991, *Construction Techniques for Sediment Pollution Control*.
- Environment Protection Authority Victoria Australia (EPA), 1995, *Environmental Guidelines for Major Construction Sites*, Report No. 480, Victoria.
- Evernden, J., 1995, 'Trapped street gullies', in *Better Management Practices for Urban Stormwater*, Stormwater Industry Association, Sydney.
- Fagan, G.W., 1993, 'A quality assessment of dynamic separation: the UK experience', *Proceedings of the 6th International Conference on Urban Storm Drainage*, Niagara Falls, pp. 1663–1670.
- Freeman, G., 1996, 'Off-line improvement of in-line stormwater quality controls', *Proceedings of the 3rd Annual Conference on Soil and Water Management for Urban Development*, Sydney.
- Galli, J., 1992, *Current Assessment of Urban Best Management Practices: Analysis of Urban BMP Longevity in Prince George County*, Metropolitan Washington Council of Governments, Washington, DC.
- Gamtron Pty Ltd, 1992, *Performance Assessment of Four Rubbish Interception Booms*, prepared for Water Board, Southern Region Stormwater Management, Rockdale, NSW.
- Gibson, T.G. and Evernden, J.A., 1992, 'Trapped street gullies', *Proceedings of the International Symposium on Urban Stormwater Management*, Sydney, February, Institution of Engineers Australia, NCP, pp. 360–363.
- Grottker, M., 1989, 'Pollutant removal by catch basins in West Germany: state of the art new design', in H.C. Torno (ed.) *Urban Stormwater Quality Enhancement: Source Control, Retrofitting and Combined Sewer Technology*, American Society of Civil Engineers, New York.
- Hall, M.D. and Phillips, D.I., 1997, 'Litter generation and distribution in commercial and strip shopping catchments', in *Future Directions for Australian Soil and Water Management: Stormwater and Soil Erosion Conference*, Brisbane, pp. 501–508.
- Hammer, D.A., 1992, *Creating Freshwater Wetlands*, Lewis Publishers.
- Hartigan, J.P., 1986, 'Regional BMP master plans' in B. Urbonas and L.A. Roesner (eds) *Urban Runoff Quality: Impact and Quality Enhancement Technology—Proceedings of an Engineering Foundation Conference*, American Society of Civil Engineers, New York.
- Harwood, R. and Saul, A. J., 1996, *Field Testing of a Storm King With Swirl Cleanse Hydrodynamic Separator Combined Sewer Overflow: Summary Report*, University of Sheffield report to the Water Research Centre, UK.

- Hocking, J., 1996, 'Evaluation of effectiveness and efficiency of Smoothey Park litter control device', *Proceedings of the 4th Annual Conference Soil and Water Management for Urban Development*, Institution of Engineers Australia, NSW.
- Horner, R.R., Skupien, J.J., Livingston, E.H. and Shaver, H.E., 1994, *Fundamentals of Urban Runoff Management*, Terrene Institute, Washington, DC.
- Horton, P.R., Cox, R.J. and Wilkinson, D.L., 1995, 'Stormwater boom performance assessment and enhancement', *Proceedings of the 16th Australian Water and Wastewater Association Federal Convention*.
- Hunter, G. and Claus, E., 1995, 'Preliminary water quality results from a constructed wetland at Plumpton Park, Blacktown', *Proceedings of the Wetlands for Water Quality Control Conference*, Townsville.
- Hunter, G., 1995, 'Constructed wetlands: safety issues', *Proceedings of the Wetlands for Water Quality Control Conference*, Townsville.
- Hunter, G.J. and Constandopoulos, J., 1997, 'Development of pollutant load retention curves for a stormwater treatment wetland at Plumpton Park, Blacktown, Sydney', *Proceedings of the Science and Technology in the Environmental Management of the Hawkesbury-Nepean Catchment Conference*, Sydney, Institution of Engineers, Australia.
- Hydro Australasia, 1997, Product description (Hydro Swirl Cleanse), Enfield, NSW.
- IMEA (Institute of Municipal Engineering Australia, Victoria Division), 1996, *Street Cleansing Code of Practice*.
- Jarret, P. and Godfrey, P., 1995, 'The role of catch basins in urban stormwater management', *Proceedings of the 2nd International Symposium on Urban Stormwater Management*, Melbourne, Institution of Engineers Australia.
- Kachka, A.M. and Turner, C., 1996, 'Performance evaluation of a water pollution control pond—Lake Annan', *Proceedings of the WaterTech Conference*, Australian Water Wastewater Association, Sydney.
- Kadlec, R.H. and Knight, R.L., 1996, *Treatment Wetlands*, CRC Press, Boca Raton, Florida.
- Krejci, V., 1989, 'Stormwater pollution control using screening structures', in American Society of Civil Engineers, *Urban Stormwater Quality Enhancement*, New York, p. 402.
- Lawrence, A.I. and Baldwin, S., 1996, 'Development of an urban pond water quality model', *Proceedings of the 7th International Conference on Urban Storm Drainage*, Hanover, Germany.
- Lawrence, A.I., 1996, 'Urban stormwater modelling: an ecological perspective', *Proceedings of the 7th International Conference on Urban Storm Drainage*, Hanover, Germany.
- Leersnyder, H., 1993, 'The Performance of Wet Detention Ponds for the Removal of Urban Stormwater Contaminants in the Auckland (NZ) Region', Master of Science thesis, University of Auckland (unpublished), New Zealand.
- Lloyd, S.D., Somes, N.L.G. and Wong, T.H.F., 1997, 'Monitoring wetland systems: let's do it right', *Proceeding of Stormwater and Soil Erosion '97*, Stormwater Industry Association, Brisbane, pp. 386–393.

- Manly Hydraulic Laboratory (MHL), 1994, *Hydraulic Model Studies of Grate, Lintel and Modified Gully Pit Designs for Pyrmont Redevelopment*, Report No. MHL690, August.
- Marsalek, J., 1993, *Laboratory Testing of Stormceptor I*, National Water Research Institute, Environment Canada, Report for Stormceptor Canada Inc.
- Marsalek, J., Long, R. and Doede, D., 1994, *Laboratory Development of Stormceptor II*, National Water Research Institute, Environment Canada, Report for Stormceptor Canada.
- Maryland Department of the Environment, 1984, *Standards and Specifications for Infiltration Practices*, Baltimore, USA.
- Maryland Department of the Environment, 1987, *Design Procedures for Stormwater Management Extended Detention Structures*, Baltimore, USA.
- Maryland Department of the Environment, 1991, *Water Quality Inlets (Oil/Grit Separators)*, Baltimore, USA.
- McKay, P. and Marshall, M., 1993, *Backyard to Bay: Tagged Litter Report*, Melbourne Water, Melbourne.
- Melbourne Water, 1997, 'List of Teaching Resources', Waterways and Drainage Fact Sheet.
- Metcalf and Eddy, 1991, *Wastewater Engineering: Treatment Disposal and Reuse*, 3rd edition, McGraw-Hill, New York.
- MMBW (Melbourne and Metropolitan Board of Works), Environment Protection Authority (Victoria), Merri Creek Parklands, City of Coburg, 1989, *Litter Control in Urban Waterways*, MMBW (now Melbourne Water) Internal Report, Book No. 006915.
- Molinari, S. and Carleton, M., 1987, 'Interception and collection of litter in urban waterways', *Proceedings of the Seminar on Urban Runoff Water Quality*, Institution of Engineers, Australia, Sydney, July.
- Mudgway, L.B., Duncan, H.P., McMahon, T.A. and Chiew, F.H.S., 1997, *Best Practice Environmental Guidelines for Urban Stormwater. Background Report to the Environmental Protection Authority, Melbourne Water Corporation and the Department of Natural Resources and Environment, Victoria*, Cooperative Research Centre for Catchment Hydrology, Report 97/7, October.
- National Capital Planning Authority, 1993, *Designing Subdivisions to Save and Manage Water*, Building Better Cities Program Occasional Paper Series 1, Paper 3.
- Nel, C., 1996, 'Die Ontwikkeling van 'n Struktuur vir die Verwydering van Vaste Besoedeling uit Stormwateraflope', PhD thesis, Technicon Pretoria, South Africa, June.
- Nguyen, T.D., 1991, 'Vibrations of beams and trash racks in parallel and inclined flows', *Journal of Hydraulic Engineering*, Vol. 117, pp. 1056–1076.
- Nielsen, J.S. and Carleton, M.G., 1989, 'A study of trash and trash interception devices on the Cooks River catchment, Sydney', *Proceedings of the 13th Australian Water and Wastewater Association Federal Convention*, Canberra, March, pp. 126–129.
- NSW Department of Housing, Housing Production Division, 1998, *Managing Urban Stormwater: Soils and Construction*.

- NSW Department of Land and Water Conservation, 1998, *The Constructed Wetlands Manual*.
- Ontario Ministry of Environment and Energy (OMEE), 1994, *Stormwater Management Practices Planning and Design Manual*, prepared by Marshall Macklin Monaghan Ltd, Toronto, Canada.
- Phillips, B.C., 1992, 'A review of design procedures for gross pollutant traps and water pollution control ponds', *Proceedings of the Design and Performance of Gross Pollutant Traps and Wet Basins Seminar*, Sydney, Institution of Engineers, Australia.
- Phillips, D.I., 1997, 'A new GPT for urban drainage systems: the In-Line Litter Separator', *Proceedings of the Stormwater and Soil Erosion Conference*, Stormwater Industry Association, Brisbane, pp. 461–469.
- Pisano, W.C., 1988, 'Swirl concentrators revisited: the American experience and new German technology', in *Design of Urban Runoff Quality Controls*, pp. 390–401.
- Rast, W., Jones, R. and Lee, G.F., 1983, 'Predictive capacity of US OECD phosphorus loading: eutrophication response models', *Journal of the Water Pollution Control Federation*, Vol. 55, No. 7.
- Russell, R.C. and Kuginis, L., 1995, 'Constructed wetlands and mosquitos: some problems and some solutions', *Proceedings of the Wetlands for Water Quality Control Conference*, Townsville.
- Schueler, T.R. and Helfrich, N., 1989, 'Design of extended detention wet pond systems', in L.A. Roesener, B. Urbonas and M.B. Sonnen (eds) *Design of Urban Runoff Quality Controls*, American Society for Civil Engineers, New York.
- Schueler, T.R., 1987, *Controlling Urban Runoff: A Practical Manual for Planning and Designing Urban BMPs*, Metropolitan Washington Council of Governments, Washington, DC.
- Schueler, T.R., 1992, *Design of Stormwater Wetland Systems: Guidelines for Creating Diverse and Effective Stormwater Wetland Systems in the Mid-Atlantic Region*, Metropolitan Washington Council of Governments, Washington, DC.
- Schueler, T.R., Kumble, P.A. and Heraty, M.A., 1992, *A Current Assessment of Urban Best Management Practices: Techniques for Reducing Non-Point Source Pollution in the Coastal Zone*, Metropolitan Washington Council of Governments, prepared for the US Environment Protection Authority.
- Shaver, E., 1995, *Use of Sand Filters as an Urban Stormwater Management Practice*, seminar publication, National Conference on Urban Runoff Management: Enhancing Urban Watershed Management at the Local County and State Levels, 30 March – 2 April 1993, Chicago, Illinois. US EPA Report No. EPA/625/R-95/003.
- Shaver, E., 1996, 'Sand filter design for stormwater treatment', *Waterfall*, Vol. 4, pp. 31–36.
- Sim, R.L. and Webster, J.L., 1992, 'Performance of a trash rack on Cup and Saucer Creek stormwater channel', *Proceedings of the International Symposium on Urban Stormwater Management*, University of Technology, Sydney, 4–7 February 1992, pp. 143–145.
- Smisson, B., 1967, 'Design, construction and performance of vortex overflows', Institution of Civil Engineers Symposium on Storm Sewage Overflows, London.



- Somes, N.L. and Wong, T.H.F., 1996, 'Designing outlet characteristics for optimal wetland performance', *Proceedings of the 7th International Conference of Urban Storm Drainage*, Hanover, Germany, Vol. 1, pp. 265–270.
- Somes, N.L., Breen, P.F. and Wong, T.H.F., 1995, 'Establishment of wetland vegetation for runoff control systems: design and installation considerations', *Proceedings of the 2nd International Symposium on Urban Stormwater Management*, Melbourne, Institution of Engineers, Australia.
- Somes, N.L.G. and Wong, T.H.F., 1998, 'Detention time distribution in constructed stormwater wetlands', *Proceedings of HydraStorm '98, 3rd International Symposium on Stormwater Management*, Adelaide, 27–30 September 1998, pp. 287–292.
- Southcott, P.H., 1995, 'A case study of a minor gross pollutant trap', *Proceedings of the 2nd International Symposium on Urban Stormwater Management*, Melbourne, Australia, 11–13 July, Vol. 2, pp. 417–422.
- Stahre, P. and Ubonas, B., 1990, *Stormwater Detention for Drainage, Water Quality and CSO Management*, Prentice Hall, New Jersey.
- State Government of Victoria, 1998, Victorian Government Gazette S-13, 'State Environment Protection Policy, Waters of Victoria'.
- State Pollution Control Commission (SPCC), 1989, *Pollution Control Manual for Urban Stormwater*, New South Wales, August.
- State Pollution Control Commission, 1989, *Pollution Control Manual for Urban Stormwater*.
- Townshend, P., 1996, 'Robinson Canal: Johannesburg, Pollution Control Works', Internal Report Urban Water Environment Management, Pinegowrie, South Africa, Fax: (011) 789 6499.
- Truong, H.V. and Phua, M.S., 1995, *Application of the Washington DC Sand Filter for Urban Runoff Control*, Seminar Publication, National Conference on Urban Runoff Management: Enhancing Urban Watershed Management at the Local, County and State Levels, 30 March – 2 April, 1993, Chicago, Illinois, US EPA, Report No. EPA/625/R-95/003.
- United States Environmental Protection Agency, 1983, *Results of the Nationwide Urban Runoff Program, Volume 1, Final Report*, Washington DC, NTIS PB84-185552.
- United States Environmental Protection Agency, 1986, *Methodology of Analysis of Detention Basins for Control of Urban Runoff Quality*, Washington DC, EPA 440/5-87-001.
- Walker, T.A., Allison, R.A., Wong, T.H.F. and Wootton, R.M., 1999, *Removal of Suspended Solids and Associated Pollutants by a CDS Gross Pollutant Trap*, Research report for the Cooperative Research Centre for Catchment Hydrology.
- Washington State Department of Ecology, 1993, *A Bridge to the Stormwater Technical Manual: A Companion Workbook*, Washington, DC.
- Waste Management Council, 1996, *Best Practices in Litter Management—A Guide for Local Government*.
- Weatherbe, D.G., Bryant, G. and Snodgrass, W., 1995, 'Performance of the Stormceptor water quality inlet', Water Environment Federation Speciality Conference: New

- and Emerging Environmental Technologies and Products, Toronto, Ontario, Canada, June.
- Whatley, R., 1994, *Community Communication Programs: A Seven Step Guide*, Major Urban Water Authorities of Australia, published by Melbourne Water.
- Whelans, Halpern Glick Maunsell, Thompson Palmer and Institute for Science and Technology Policy, Murdoch University, 1993, *Water Sensitive Urban (Residential) Design Guidelines for the Perth Metropolitan Region: Discussion Paper*, prepared for the Department of Planning and Urban Design, the Water Authority of Western Australia and the Environment Protection Authority.
- Whelans, Halpern Glick Maunsell, Thompson Palmer and Murdoch University, 1994, *Planning and Management Guidelines for Water Sensitive Urban (Residential) Design*, prepared for Department of Planning and Urban Development, Water Authority of Western Australia and the Environment Protection Authority.
- Whytcross, G.J., Johnston, T.A., Nagy, L.A. and Farrant, A.A., 1989, 'Physical, chemical and biological processes within a gross pollutant trap and their management implications', Poster paper, Australian Water and Wastewater Association Federal Convention, Canberra.
- Willing and Partners Pty Ltd, 1989, *Gross Pollutant Trap Design Guidelines*, prepared for Lake Macquarie City Council.
- Willing and Partners Pty Ltd, 1992a, *Design Guidelines for Gross Pollutant Traps*, prepared for ACT Department of Environment, Land and Planning and the Department of Urban Services.
- Willing and Partners Pty Ltd, 1992b, *Gross Pollutant Trap Design Manual*, prepared for Sutherland Shire Council.
- Wong, T.H.F and Geiger, W.F., (in press), *Adaptation of Wastewater Surface Flow Wetland Formulae for Application in Constructed Stormwater Wetlands*, Ecological Engineering.
- Wong, T.H.F., Breen, P.F., and Brizga, S., 1997, *Hydraulic, Geomorphological and Ecological Effects of Catchment Urbanisation*, Cooperative Research Centre for Catchment Hydrology, Clayton, Victoria.
- Wong, T.H.F., Wootton, R.M. and Fabian D., 1996, *A Solids Separator Using a Continuous Deflective System*. Department of Civil Engineering, Monash University, Melbourne.
- Wong, T.H.F. (ed.), 1999, 'Short Course on Planning and Design of Stormwater Management Measures', course notes, Department of Civil Engineering and the Cooperative Research Centre for Catchment Hydrology.
- Wong, T.H.F., Breen, P.F., Lawrence, I., Somes, N.L.G. and Lloyd, S.D., 1999, 'Design guidelines for constructed wetland systems', Cooperative Research Centre report in preparation.
- Wong, T.H.F., Breen, P.F., Somes, N.L.G. and Lloyd, S.D., 1998, *Managing Urban Stormwater Using Constructed Wetlands*, Industry Report 98/7, Cooperative Research Centre for Catchment Hydrology, November.
- Woodfull, J., Finlayson, B. and McMahon, T., 1992, *The Role of Buffer Strips in the Management of Waterway Pollution from Diffuse Urban and Rural Sources, Land and Water Resources Research Development Corporation*, Melbourne, Occasional Paper No. 01/93.